

**ANSALDO****Ansaldo Trasporti s.p.a.  
Unita' Semiconduttori**Via N. Lorenzi 8 - I 16152 GENOVA - ITALY  
Tel. int. +39/(0)10 6556549 - (0)10 6556488  
Fax Int. +39/(0)10 6442510  
Tx 270318 ANSUSE I -**FAST RECOVERY DIODE****ARF322**

Repetitive voltage up to	<b>1600 V</b>
Mean forward current	<b>740 A</b>
Surge current	<b>11 kA</b>

**FINAL SPECIFICATION**

ott 97 - ISSUE : 04

Symbol	Characteristic	Conditions	T <sub>j</sub> [°C]	Value	Unit
<b>BLOCKING</b>					
V <sub>RRM</sub>	Repetitive peak reverse voltage		125	1600	V
V <sub>RSM</sub>	Non-repetitive peak reverse voltage		125	1700	V
I <sub>RRM</sub>	Repetitive peak reverse current	V=VRRM	125	50	mA
<b>CONDUCTING</b>					
I <sub>F(AV)</sub>	Mean forward current	180° sin ,50 Hz, Th=55°C, double side cooled		740	A
I <sub>F(AV)</sub>	Mean forward current	180° square,50 Hz,Th=55°C,double side cooled		740	A
I <sub>FSM</sub>	Surge forward current	Sine wave, 10 ms	125	11	kA
I <sup>2</sup> t	I <sup>2</sup> t	reapplied reverse voltage up to 50% VRSM		605 x1E3	A <sup>2</sup> s
V <sub>FM</sub>	Forward voltage	Forward current : 1200 A	25	1.65	V
V <sub>F(TO)</sub>	Threshold voltage		125	0.90	V
r <sub>F</sub>	Forward slope resistance		125	0.500	mohm
<b>SWITCHING</b>					
t <sub>rr</sub>	Reverse recovery time	I <sub>F</sub> = 1000 A	125	2.0	μs
Q <sub>rr</sub>	Reverse recovery charge	di/dt= 60 A/μs		60	μC
I <sub>rr</sub>	Peak reverse recovery current	VR = 50 V		70	A
s	Softness (s-factor), min			0.5	
V <sub>FR</sub>	Peak forward recovery	di/dt= 100 A/μs		4	V
<b>MOUNTING</b>					
R <sub>th(j-h)</sub>	Thermal impedance	Junction to heatsink, double side cooled		52	°C/kW
T <sub>j</sub>	Operating junction temperature			-30 / 125	°C
F	Mounting force			8.4 / 9.4	kN
	Mass			280	g

**ORDERING INFORMATION : ARF322 S 16**standard specification   VRRM/100

DISSIPATION CHARACTERISTICS

SQUARE WAVE

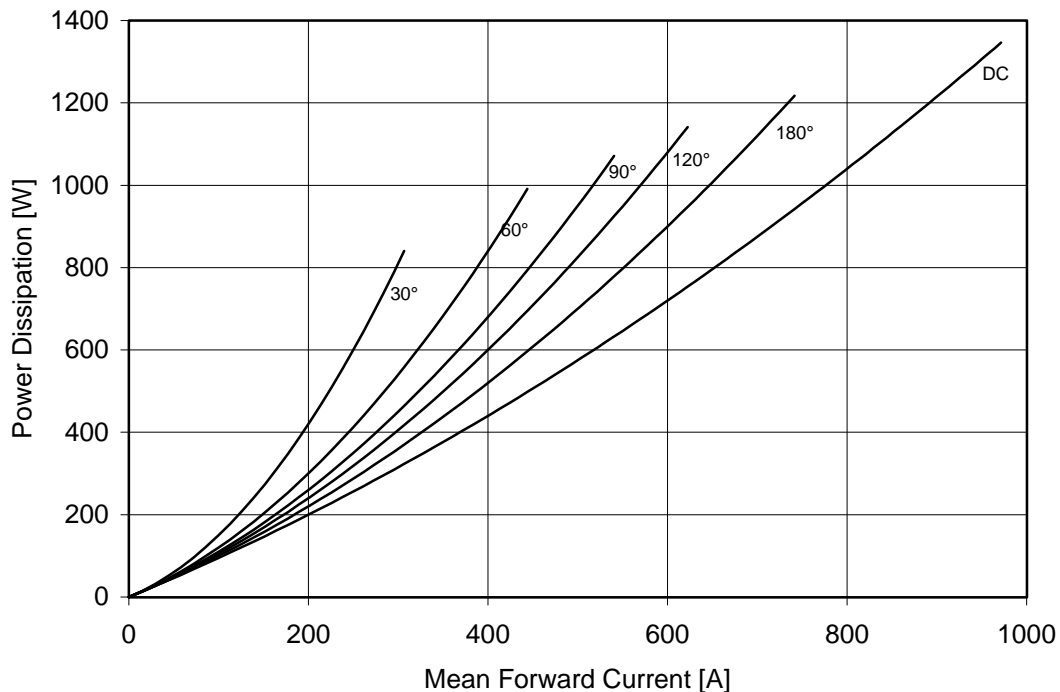

SINE WAVE

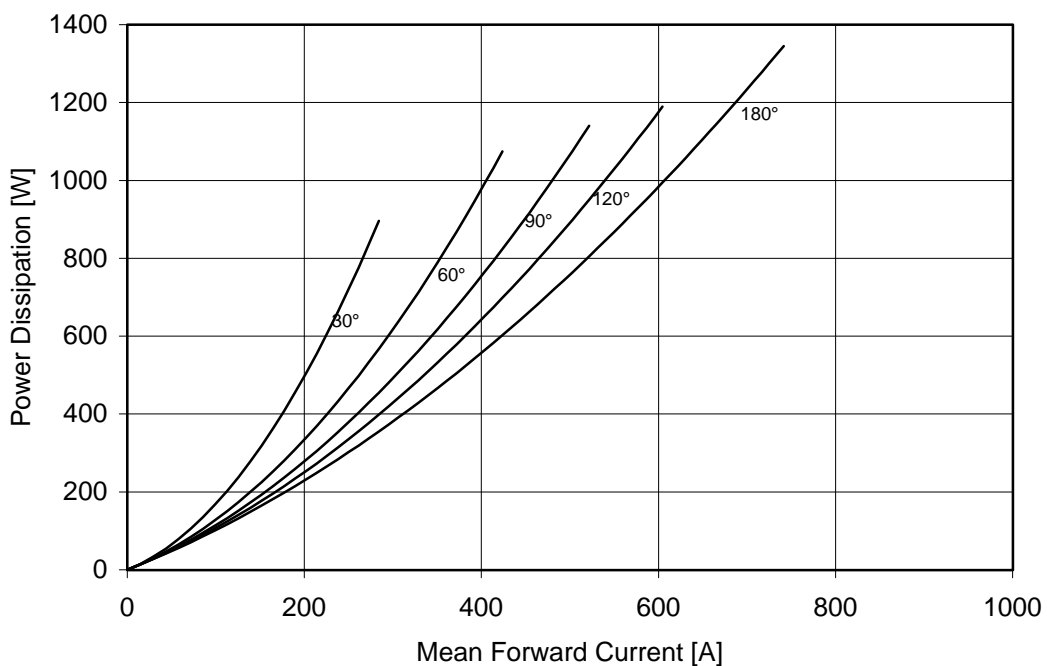

## SWITCHING CHARACTERISTICS

FORWARD RECOVERY VOLTAGE

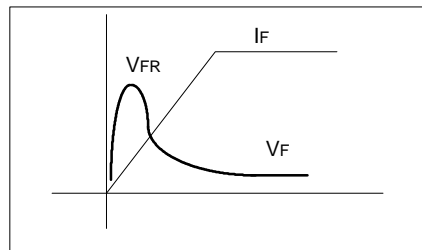
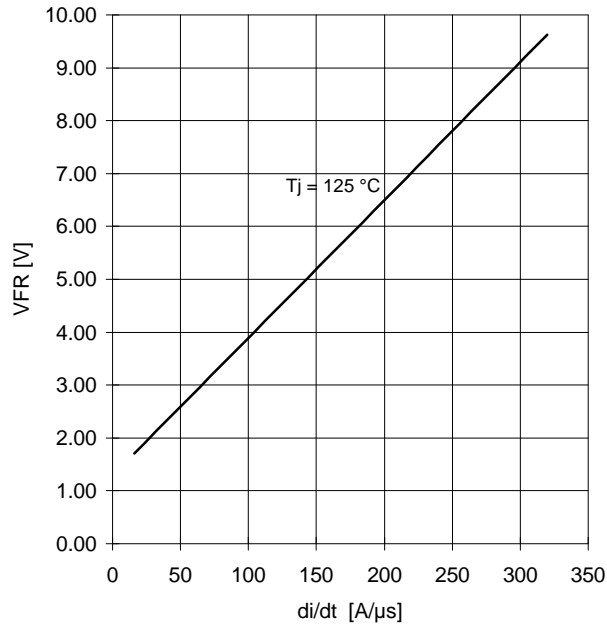

REVERSE RECOVERY CHARGE  
Tj = 125 °C

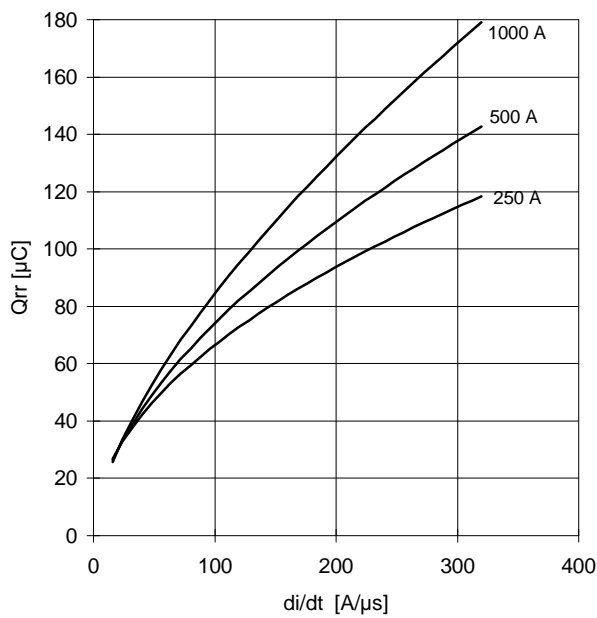

REVERSE RECOVERY CURRENT  
Tj = 125 °C

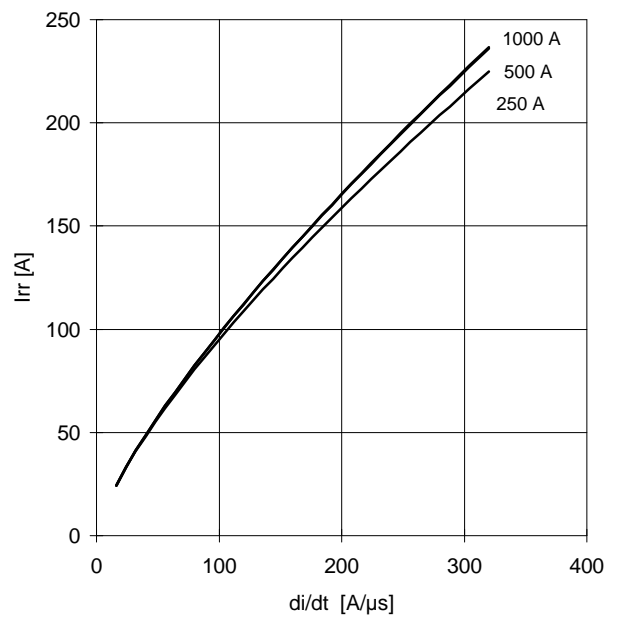

$$t_a = I_{rr} / (di/dt) \quad t_b = t_{rr} - t_a$$

$$\text{Softness (s factor)} \quad s = t_b / t_a$$

$$\text{Energy dissipation during recovery} \quad E_r = V_r \cdot (Q_{rr} - I_{rr} \cdot t_a / 2)$$

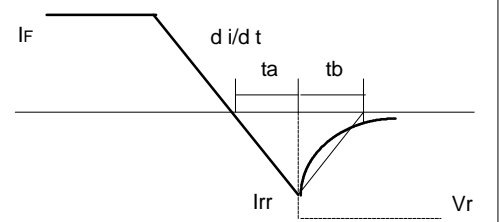

FORWARD CHARACTERISTIC  
T<sub>j</sub> = 125 °C

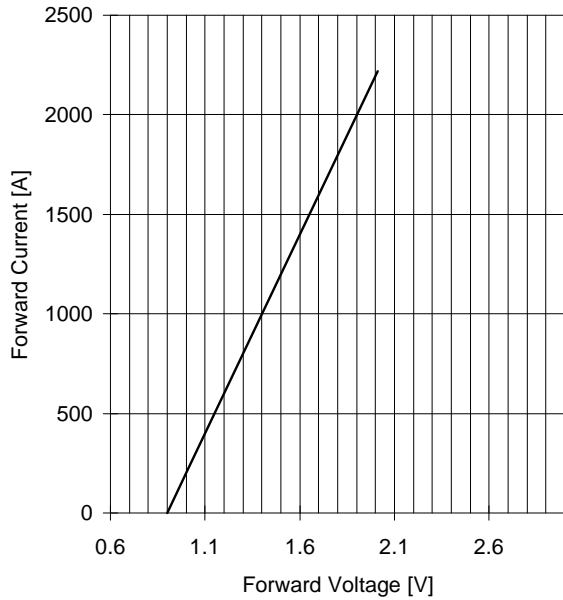

SURGE CHARACTERISTIC  
T<sub>j</sub> = 125 °C

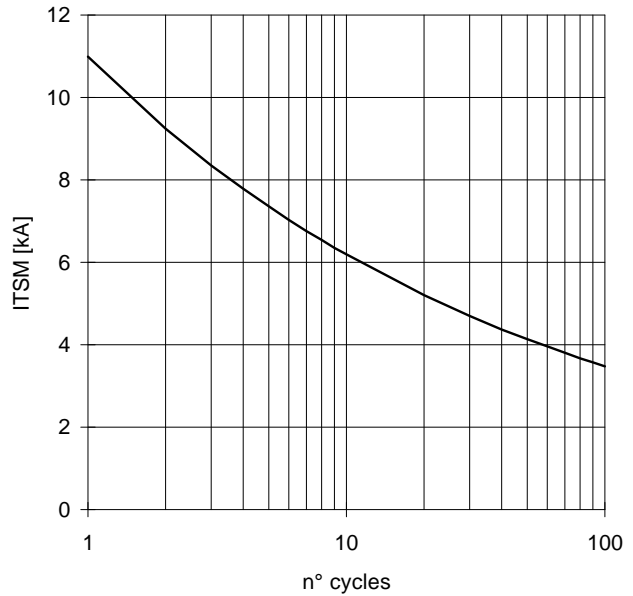

TRANSIENT THERMAL IMPEDANCE  
DOUBLE SIDE COOLED

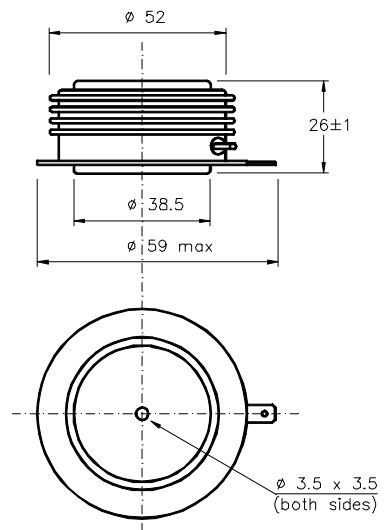
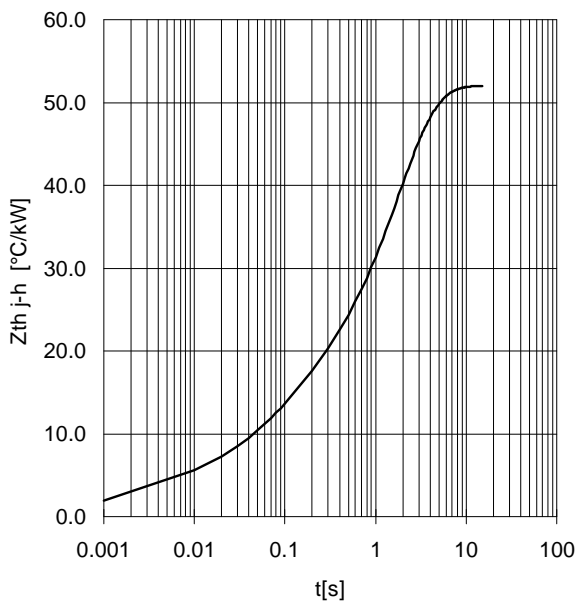

Dimensions in mm



All the characteristics given in this data sheet are guaranteed only with uniform clamping force, cleaned and lubricated heatsink, surfaces with flatness < .03 mm and roughness < 2  $\mu\text{m}$ .

In the interest of product improvement ANSALDO reserves the right to change any data given in this data sheet at any time without previous notice.

If not stated otherwise the maximum value of ratings (symbols over shaded background) and characteristics is reported.

Distributed by

