

RFID Reader (Passive)

ARRUN5-915.000MHz

MSL level: Not Applicable

RoHS/RoHS II Compliant

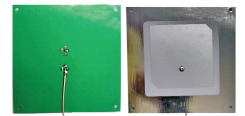

120.0 x 120.0 x 9.5mm

FEATURES:

- High Gain
- Easy to install
- RF Cable and Connector
- RoHS Compliant

TYPICAL APPLICATIONS:

RFID systems for Logistic & Inventory Management of Retail, Pharmaceutical, Automotive Industries; Industrial automation, Contactless smart cards.

STANDARD SPECIFICATIONS:

Parameters	Min.	Typ.	Max.	Units	Note
Center Frequency		915±3		MHz	
V.S.W.R		1.5			
Bandwidth	20.0			MHz	V.S.W.R<1.5
Impedence		50		Ω	
Gain		5.5		dBi	Based on 120×120mm ground plane
Polarization		RHCP			
Working Temperature	-40		+80	°C	
Storage Temperature	-45		+85	°C	

SMITH CHART:

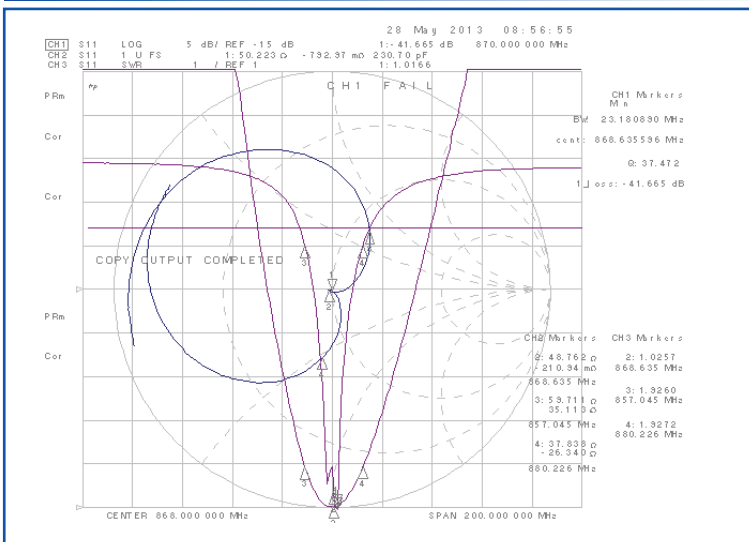

RADIATION PATTERN

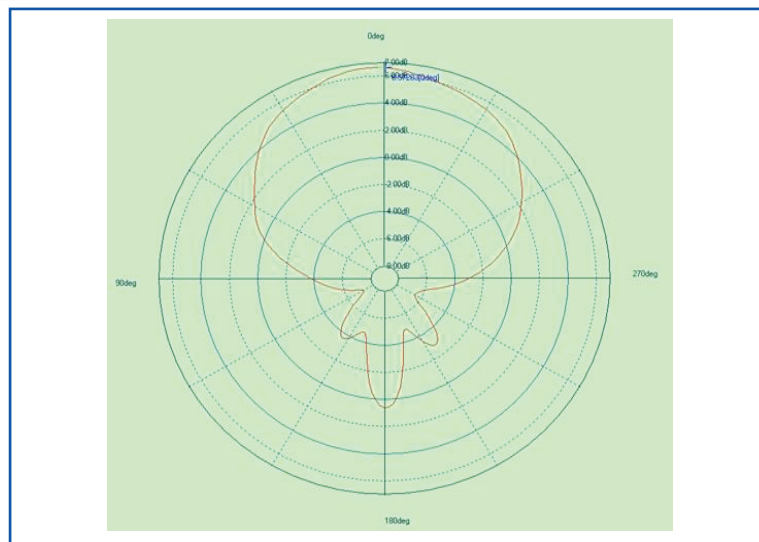

OUTLINE DRAWING:

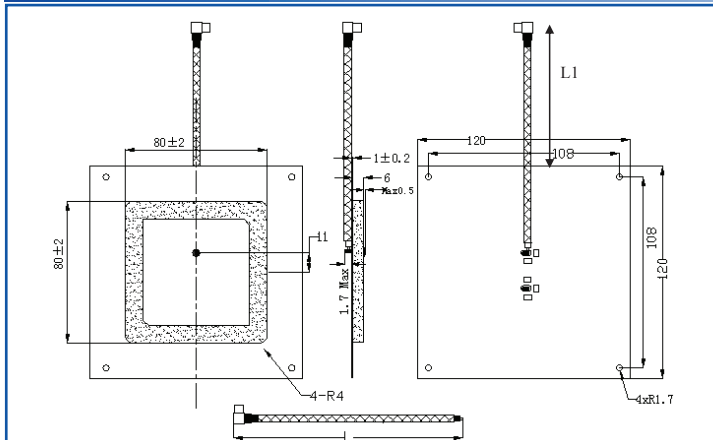

Other Tolerance: ±0.5mm

Description	Material
Antenna Type	Dielectric Ceramics 80x80x6mm
PCB	FR4, 120mm
RF Cable	RG178, Ø 2.7±0.3mm, L1=60±5mm, L=110±5mm
RF Connector	MMCX-JW3
Thickness	9.5mm Max

Unit: mm

ABRACON IS
ISO9001:2008
CERTIFIED

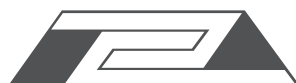

ABRACON
CORPORATION

2 Faraday, Suite# B | Irvine | CA 92618 **Revised: 11.24.14**
Ph. 949.546.8000 | Fax. 949.546.8001
Visit www.abracon.com for Terms and Conditions of Sale

RFID Reader (Passive)

ARRUN5-915.000MHz

RoHS/RoHS II Compliant



120.0 x 120.0 x 9.5mm

TAPE & REEL:

Each 150 * 100 * 130 mm inner box contains 5pcs of antenna which are inserted into the card slots. Each 770 * 320 * 280 mm size Carton (outer box) positions 10 inner boxes. The total number of antenna per carton is 50pcs

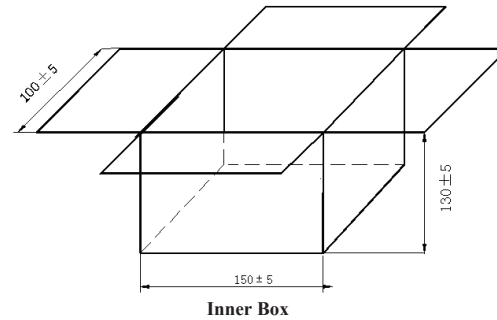
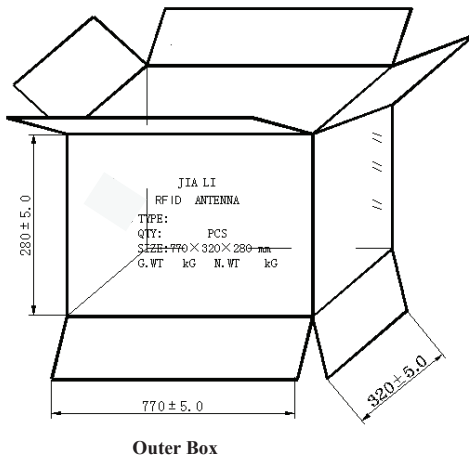

Outer Box

Unit: mm

CAUTION:

- (1) Do not apply excess mechanical stress to the component body or terminations. Do not attempt to re-form or bend the components as this will cause damage to the component.
- (2) Do not expose the component to open flame.
- (3) This specification applies to the functionality of the component as a single unit. Please insure the component is thoroughly evaluated in the application circuit.

NOTE:

- (1) The parts are manufactured in accordance with this specification. If other conditions and specifications which are required for this specification, please contact ABRACON for more information.
- (2) ABRACON will supply the parts in accordance with this specification unless we receive a written request to modify prior to an order placement.
- (3) In no case shall ABRACON be liable for any product failure from in appropriate handling or operation of the item beyond the scope of this specification.
- (4) When changing your production process, please notify ABRACON immediately.
- (5) ABRACON Corporation's products are COTS – Commercial-Off-The-Shelf products; suitable for Commercial, Industrial and, where designated, Automotive Applications. ABRACON's products are not specifically designed for Military, Aviation, Aerospace, Life-dependant Medical applications or any application requiring high reliability where component failure could result in loss of life and/or property. For applications requiring high reliability and/or presenting an extreme operating environment, written consent and authorization from ABRACON Corporation is required. Please contact ABRACON Corporation for more information.
- (6) All specifications and Marking will be subject to change without notice.

ATTENTION: Abracon Corporation's products are COTS – Commercial-Off-The-Shelf products; suitable for Commercial, Industrial and, where designated, Automotive Applications. Abracon's products are not specifically designed for Military, Aviation, Aerospace, Life-dependant Medical applications or any application requiring high reliability where component failure could result in loss of life and/or property. For applications requiring high reliability and/or presenting an extreme operating environment, written consent and authorization from Abracon Corporation is required. Please contact Abracon Corporation for more information.

ABRACON IS
ISO9001:2008
CERTIFIED



2 Faraday, Suite# B | Irvine | CA 92618 **Revised: 11.24.14**
Ph. 949.546.8000 | Fax. 949.546.8001
Visit www.abracon.com for Terms and Conditions of Sale