

AS1341

650mA, Ultra low Ripple Step Down DC/DC Converter

1 General Description

The AS1341 is a high-efficiency step-down converter with adjustable output voltages from 1.25V to V_{IN} using supply voltages of up to 20V.

An integrated current-limited 0.4 Ω MOSFET delivers load currents up to 600mA.

The AS1341 also includes a 100% duty cycle LDO mode with a low dropout of only 250mV for high efficiency if input voltages is in the range of the output voltage.

The AS1341 has a low quiescent current (12 μ A) to improve light-load efficiency and minimize battery use, and draws only 0.8 μ A in shutdown mode.

High switching frequencies (up to 200kHz) allow the use of small surface-mount inductors and output capacitors.

The device is available in a TDFN-8 3x3mm pin package.

2 Key Features

- Output Voltages: Fixed 5V or Adjustable
- Input Voltage Range: 4.5V to 20V
- Output Current: Up to 600mA
- 1.25V Lowest Output Voltage
- Efficiency: up to 96%
- Quiescent Supply Current: 12 μ A
- Power-OK Output
- Internal 0.4 Ω P-Channel MOSFET
- Shutdown Current: 0.8 μ A
- 100% Maximum Duty Cycle for Low Dropout
- Current-Limited Architecture
- Thermal Shutdown
- TDFN-8 3x3mm Package

3 Applications

The device is ideal for notebook computers, distributed power systems, keep-alive supplies, and any other battery-operated, portable device.

Figure 1. AS1341 - Typical Application

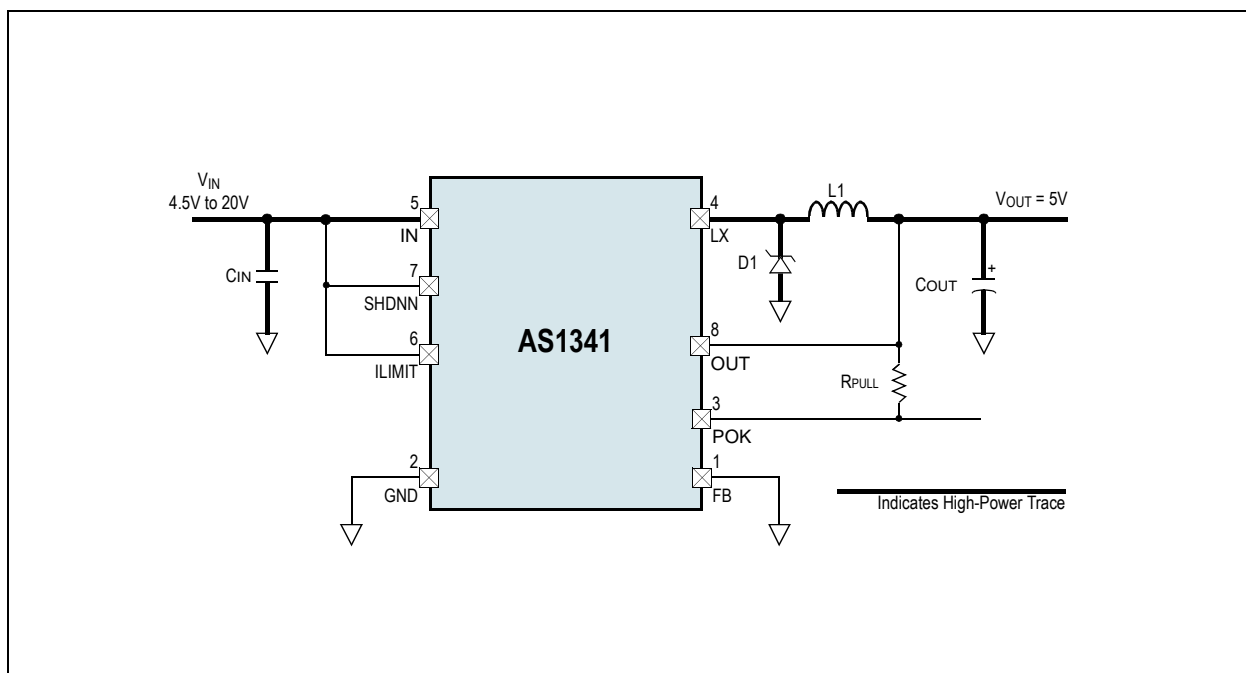



4 Pin Assignments

Figure 2. Pin Assignments (Top View)

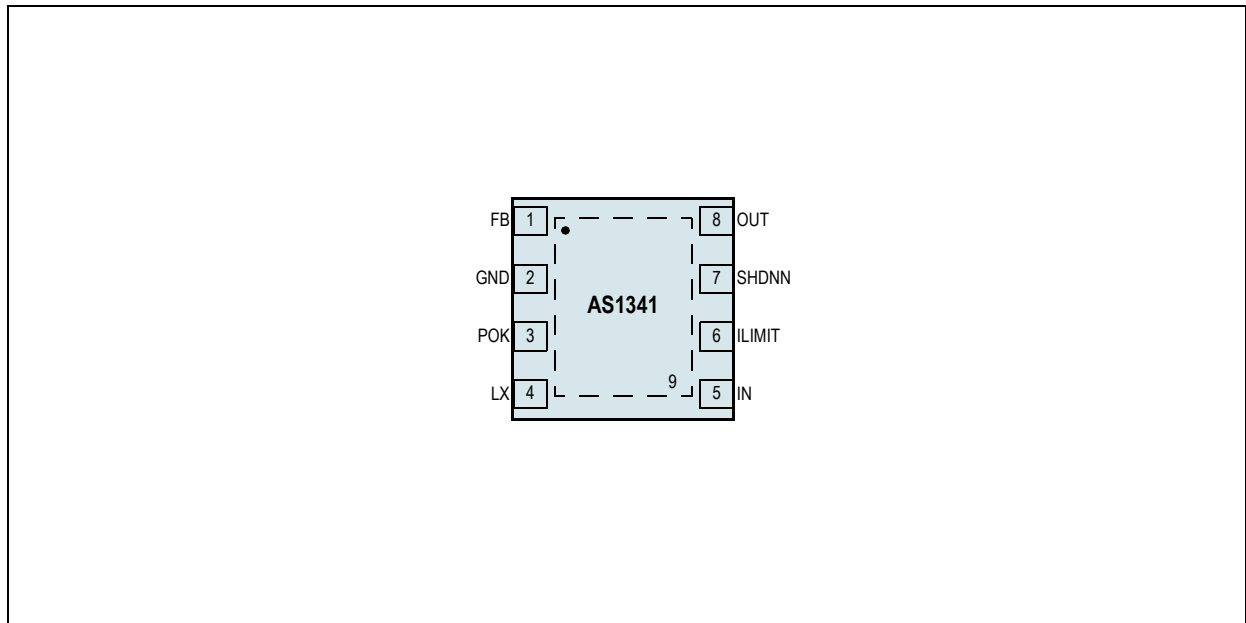

4.1 Pin Descriptions

Table 1. Pin Descriptions

Pin Number	Pin Name	Description
1	FB	Feedback Input. For the fixed 5V output connect this pin to GND. For adjustable output, connect to a resistive divider between V _{OUT} and GND to set the output voltage between 1.25V and V _{IN} .
2	GND	Ground
3	POK	Power OK. Active-low open-drain reset output. Note: Connect pin POK to GND when the Power-Ok feature is not used.
4	LX	Inductor Connection. Connect this pin to an external inductor.
5	IN	4.5V to 20V Input Supply Voltage
6	ILIMIT	Peak Current Control Input. Connect this pin to IN or GND to set peak current limit (see Setting Current Limit on page 11).
7	SHDNN	Shutdown Input. A low on this pin puts the AS1341 into shutdown mode. Supply current is reduced to 0.8μA and LX goes high-impedance.
8	OUT	Regulated Output Voltage High-Impedance Sense Input. For the fixed 5V output connect this pin to V _{OUT} . For adjustable output connect this pin to GND.
9	NC	Exposed Pad. This pad is not connected internally. Connect to GND or do not connect.



5 Absolute Maximum Ratings

Stresses beyond those listed in [Table 2](#) may cause permanent damage to the device. These are stress ratings only, and functional operation of the device at these or any other conditions beyond those indicated in [Electrical Characteristics on page 4](#) is not implied. Exposure to absolute maximum rating conditions for extended periods may affect device reliability.

Table 2. Absolute Maximum Ratings

Parameter	Min	Max	Units	Comments
Electrical Parameters				
IN to GND	-0.3	+23	V	
LX to GND	-2	$V_{IN} + 0.3$	V	
FB to GND	-0.3	+5	V	
ILIMIT, SHDNN, OUT, POK to GND	-0.3	$V_{IN} + 0.3$	V	
Peak Input Current		2	A	
Temperature Ranges and Storage Conditions				
Thermal Resistance Θ_{JA}		36.3	°C/W	on PCB
Storage Temperature Range	-55	+150	°C	
Junction Temperature		+150	°C	
Package Body Temperature		+260	°C	The reflow peak soldering temperature (body temperature) specified is in accordance with <i>IPC/JEDEC J-STD-020 "Moisture/Reflow Sensitivity Classification for Non-Hermetic Solid State Surface Mount Devices"</i> . The lead finish for Pb-free leaded packages is matte tin (100% Sn).
Humidity non-condensing	5	85	%	
Moisture Sensitive Level		1		Represents a max. floor life time of unlimited



6 Electrical Characteristics

$V_{IN} = +12V$, $SHDNN = V_{IN}$, Typical values are at $T_{AMB} = +25^{\circ}C$ (unless otherwise specified). Specifications based on circuit shown in Figure 1 on page 1.

Table 3. Electrical Characteristics

Symbol	Parameter	Conditions	Min	Typ	Max	Units
TAMB	Operating Temperature Range		-45		85	°C
VIN	Input Voltage Range		4.5		20	V
VOUT	Output Voltage (Preset Output)	FB = GND	4.85	5.00	5.15	V
	Output Voltage (Adjustable)		1.25		VIN	
VDRPOUT	Dropout Voltage	IOUT = 600mA, ILIMIT = VIN		250		mV
	Line Regulation	VIN = 6V to 20V, 200Ω load		0.1		%/V
	Load Regulation	ILIMIT = VIN, IOUT = 0 to 500mA		1		%
VFB	Feedback Set Voltage (Adjustable Output)		1.212	1.25	1.288	V
IIN	Input Supply Current	No load		12	18	μA
IINDROP	Input Supply Current in Dropout	No load		45	60	μA
	Input Shutdown Current	SHDNN = GND		0.8	3	μA
VUVLO	Input Undervoltage Lockout Threshold	VIN rising	3.6	4.0	4.4	V
		VIN falling	3.5	3.9	4.3	
	OUT Bias Current	VOUT = 5.5V	2	3.5	5	μA
IFB	FB Bias Current	VFB = 1.3V	-25		+25	nA
	FB Threshold Low		50	100	150	mV
	Thermal Shutdown	10°C hysteresis		145		°C
DC-DC Switches						
toFFMIN	LX Switch Minimum Off-Time		0.2	0.4	0.6	μs
tonMAX	LX Switch Maximum On-Time	VFB = 1.3V	8	10	12	μs
RLX	LX Switch On-Resistance	VIN = 6V		0.4		Ω
		VIN = 4.5V		0.5		
ILXPEAK	LX Current Limit	ILIMIT = GND, L = 39μH	500	700	900	mA
		ILIMIT = IN, L = 10μH	1000	1400	1800	
	LX Zero-Crossing Threshold		-75		+75	mV
	Zero-Crossing Timeout	LX does not rise above the threshold		30		μs
	LX Switch Leakage Current	VIN = 20V, LX = GND, TAMB = +25°C			0.1	μA
		VIN = 20V, LX = GND			1	
Control Inputs						
	Digital Input Level	SHDNN, ILIMIT = GND			0.8	V
		SHDNN, ILIMIT = IN	2.4			
	Digital Input Leakage Current	VSHDNN, VILIMIT = 0 to 20V, VIN = 20V	-100		+100	nA
Power-OK						
	Power-OK Threshold	Falling edge, relative to VOUT	90	92.5	95	%
	POK Output Voltage Low	IPOK = 1mA			0.4	V
	POK Output Leakage Current	VIN, VPOK = 16V, TAMB = 25°C			0.1	μA
		VIN, VPOK = 16V			1	

Note: All limits are guaranteed. The parameters with min and max values are guaranteed with production tests or SQC (Statistical Quality Control) methods.



7 Typical Operating Characteristics

$V_{OUT} = 5V$, $T_{AMB} = +25^{\circ}C$ (unless otherwise specified).

Figure 3. Efficiency vs. I_{OUT}

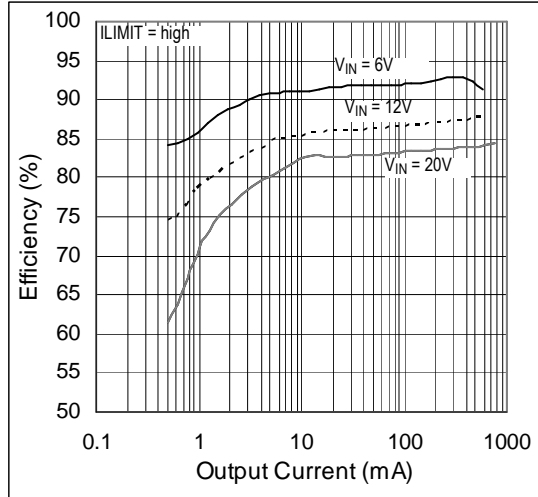

Figure 4. Efficiency vs. I_{OUT}

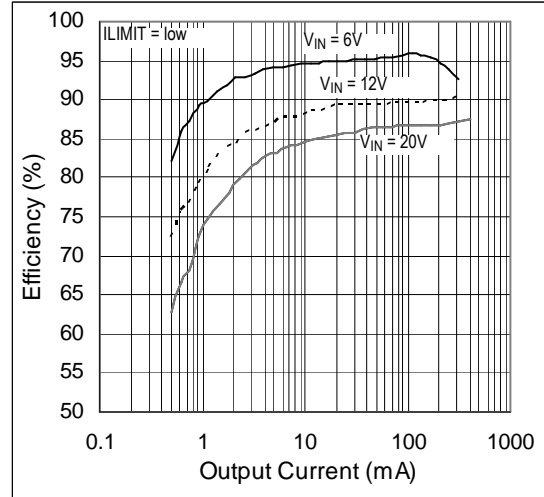

Figure 5. Efficiency vs. I_{OUT} ; $V_{OUT} = 3.3V$

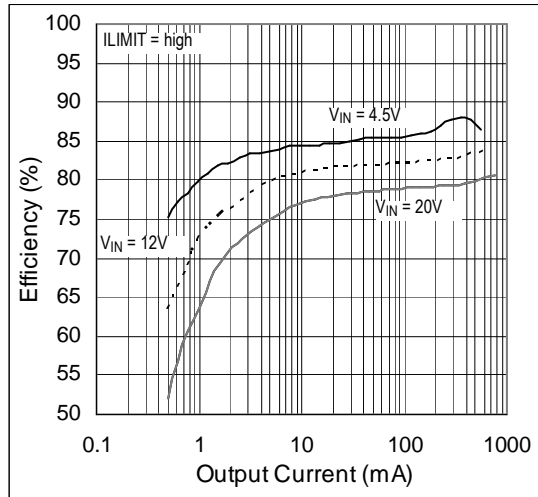

Figure 6. Efficiency vs. I_{OUT} ; $V_{OUT} = 3.3V$

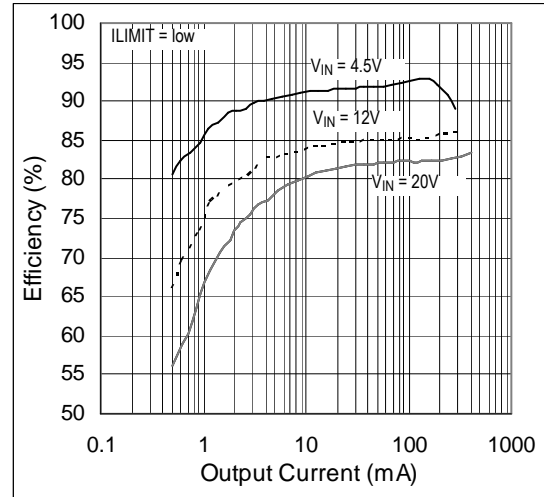

Figure 7. Efficiency vs. I_{OUT} ; $V_{IN} = 12V$

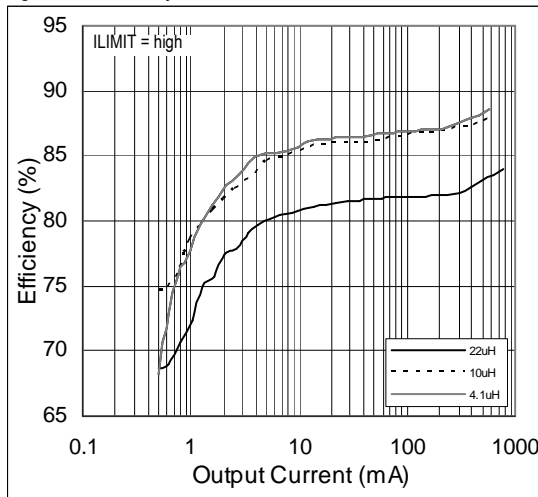

Figure 8. Efficiency vs. I_{OUT} ; $V_{IN} = 12V$

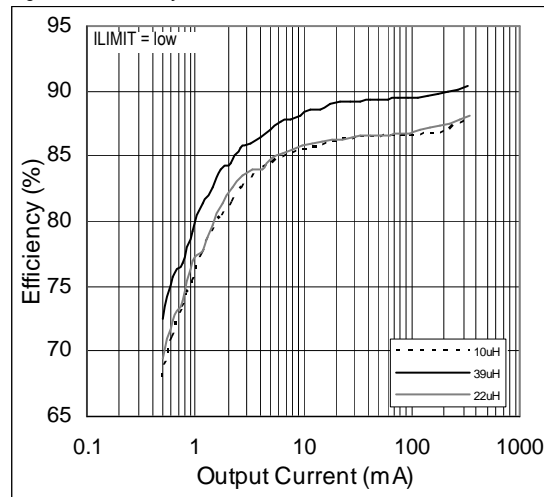



Figure 9. Efficiency vs. Input Voltage

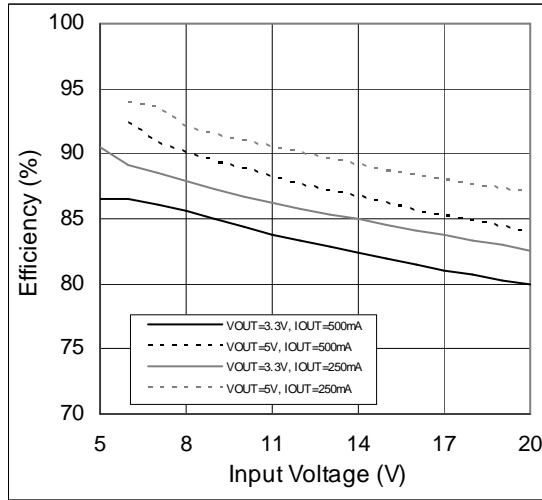

Figure 10. Output Voltage vs. Input Voltage

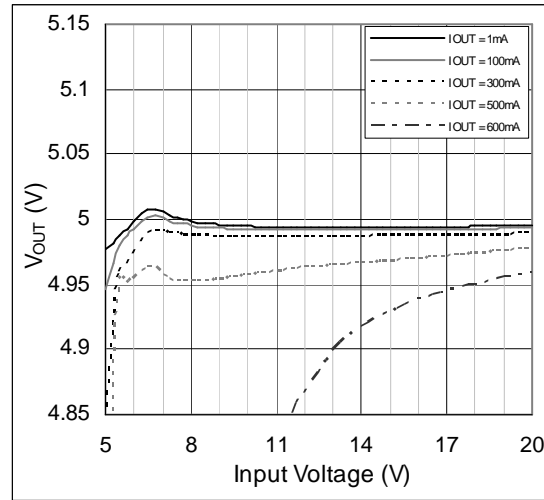

Figure 11. Output Voltage vs. Input Voltage; VOUT = 3.3V

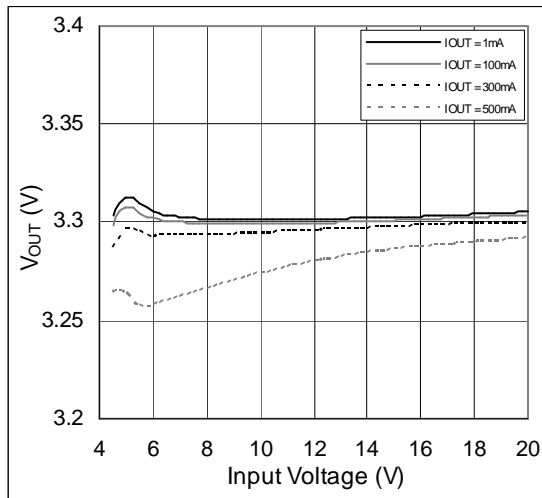

Figure 12. Peak Switch Current vs. Input Voltage; VOUT = 3.3V

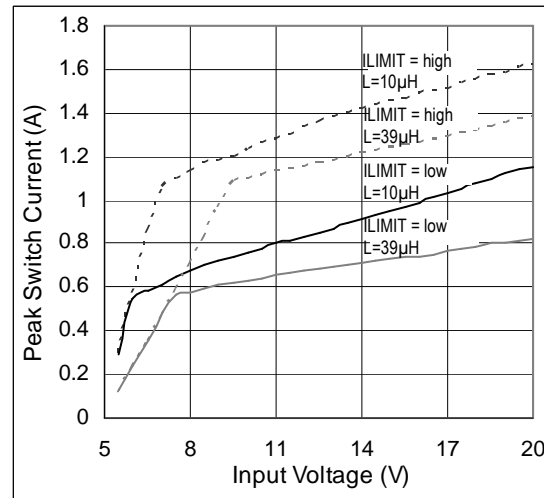

Figure 13. Switching Frequency vs. Output Current; VIN = 12V, VOUT = 5V, L = 10µH

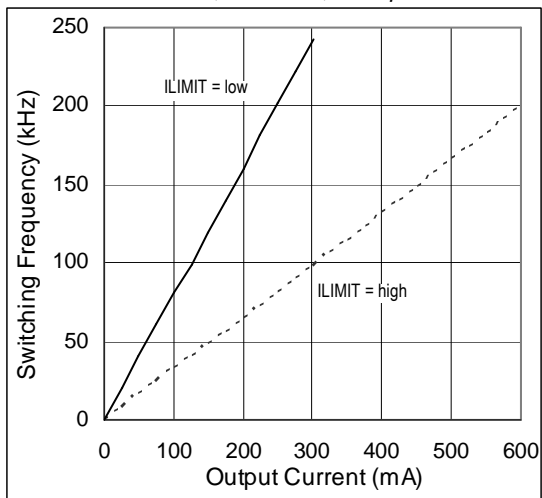

Figure 14. Switching Frequency vs. Output Current; VIN = 12V, VOUT = 3.3V, L = 10µH

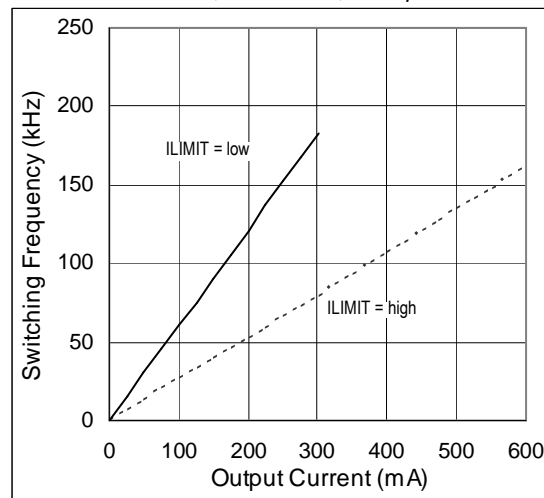



Figure 15. Load Regulation, V_{OUT} vs. I_{OUT} ; $V_{IN} = 12V$, $V_{OUT} = 5V$

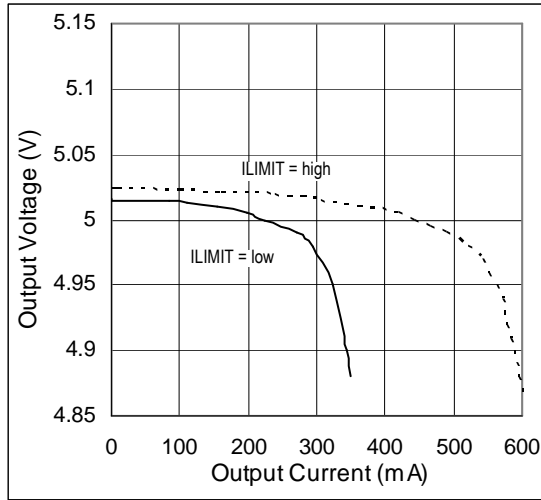

Figure 16. Load Regulation, V_{OUT} vs. I_{OUT} ; $V_{IN} = 12V$, $V_{OUT} = 3.3V$

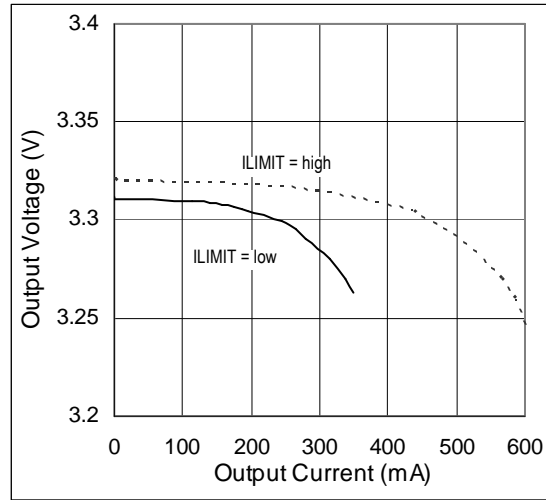

Figure 17. Line Transient Response; $I_{OUT} = 500mA$

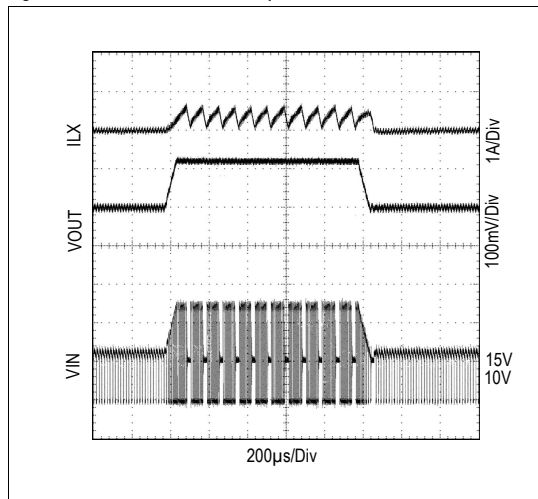

Figure 18. Load Transient Response

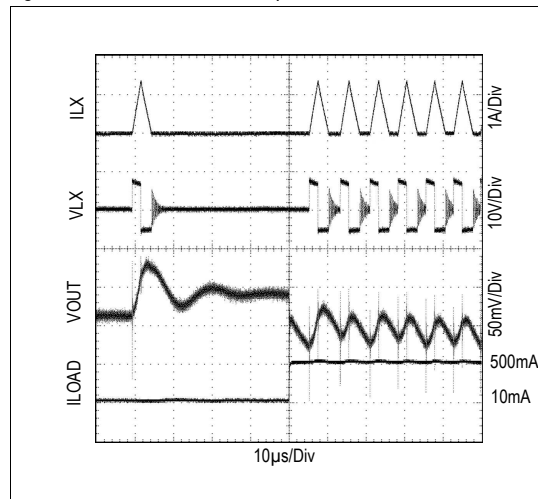

Figure 19. LX Waveform; $V_{IN} = 20V$, $I_{OUT} = 500mA$

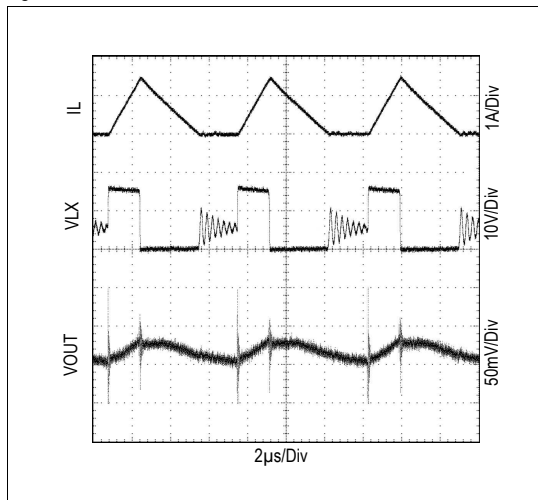
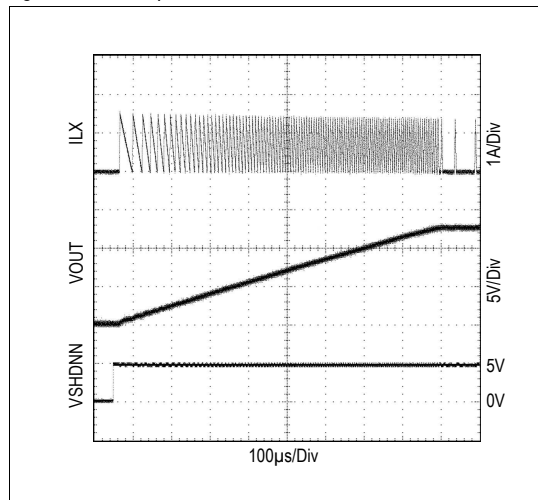

Figure 20. Startup Waveform; $R_{LOAD} = 100\Omega$





8 Detailed Description

The AS1341 step-down converter was specifically designed for battery-powered portable devices, including laptop computers, PDAs, and MP3/DVD/CD players. The advanced current-limited control scheme provides high-efficiency over a wide range of output loads. The highly-efficient operation (up to 100% duty cycle) allows extremely low dropout voltage, increasing the usable supply voltage range. In no-load conditions the AS1341 draws only 12 μ A; in shutdown mode it draws only 0.8 μ A to further reduce power consumption and extend battery life.

The AS1341 features an integrated 20V switching MOSFET, internal current sensing, and a high switching frequency, for minimal PCB space and external component requirements.

Figure 21. AS1341 - Block Diagram - 5V fixed Output Voltage

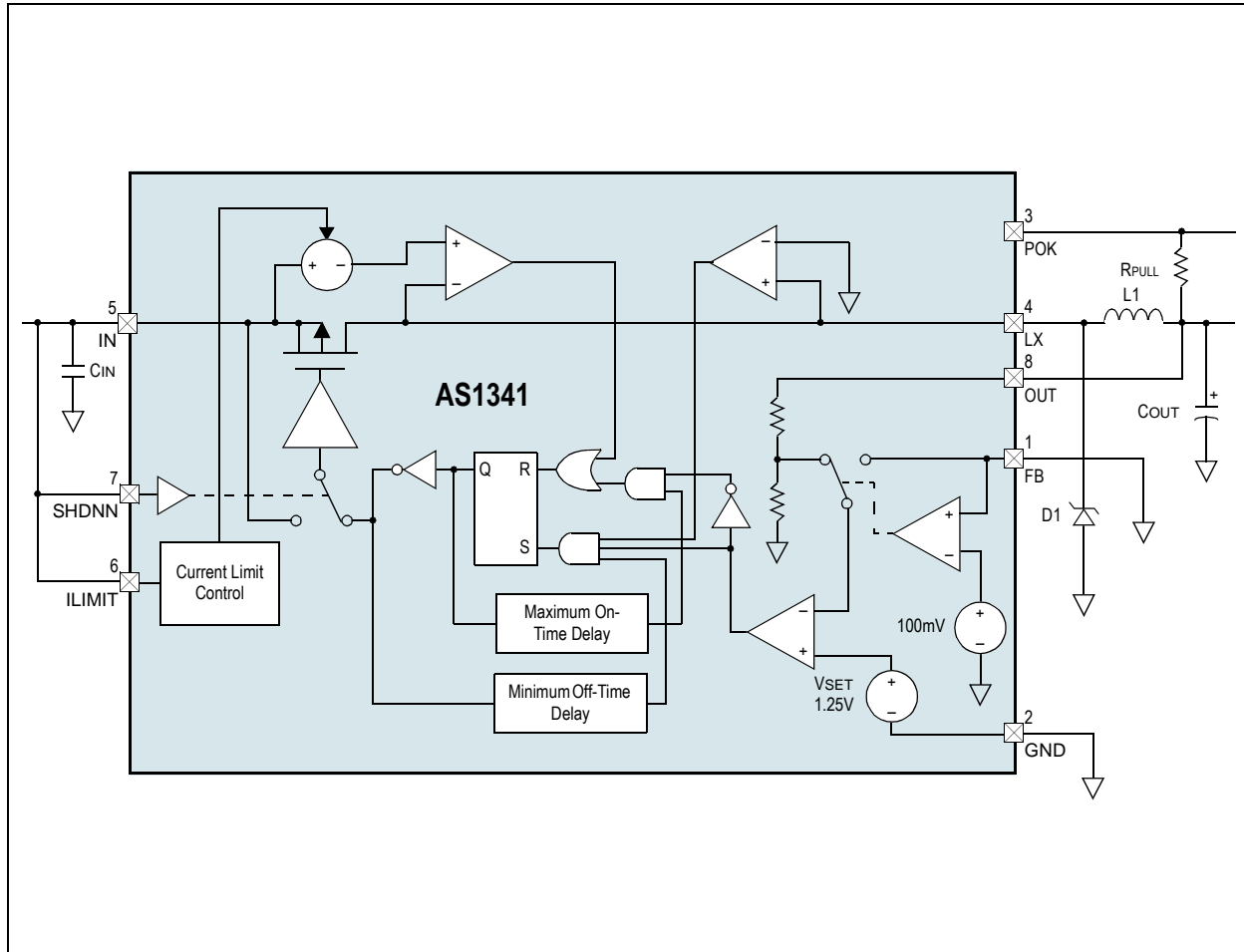

8.1 Current-Limit Control

The AS1341 uses a proprietary current-limiting control scheme with operation up to 100% duty cycle. The DC-DC converter pulses as needed to maintain regulation, resulting in a variable switching frequency that increases with the load. This eliminates the high-supply currents associated with conventional constant-frequency pulse-width-modulation (PWM) controllers that unnecessarily switch the MOSFET.

When the output voltage is too low, the error comparator sets a flip-flop, which turns on the internal P-channel MOSFET and begins a switching cycle. The inductor current ramps up linearly, storing energy in a magnetic field while charging the output capacitor and servicing the load (see Figure 19 on page 7).

The MOSFET turns off when the peak current limit is reached, or when the maximum on-time of 10 μ s is exceeded and the output voltage is in regulation. If the output is out of regulation and the peak current is never reached, the MOSFET remains on, allowing a duty cycle up to 100%. This feature ensures the lowest possible dropout voltage.

Once the MOSFET turns off, the flip-flop resets, the inductor current is pulled through D1 (see Figure 21), and the current through the inductor ramps back down, transferring the stored energy to the output capacitor and load. The MOSFET remains off until the 0.4 μ s minimum off-time expires, and the output voltage goes out of regulation.



8.2 Dropout Voltage

A buck converter's minimum input-to-output voltage differential (dropout voltage) determines the lowest usable supply voltage. In battery-powered systems, this limits the useful end-of-life battery voltage. To maximize battery life, the AS1341 operates with duty cycles up to 100%, which minimizes the dropout voltage and eliminates switching losses while in dropout. When the supply voltage approaches the output voltage, the P-channel MOSFET remains on continuously to supply the load.

Note: Dropout voltage is defined as the difference between the input and output voltages when the input is low enough for the output to drop out of regulation.

For a step-down converter with 100% duty cycle, dropout is related to the MOSFET drain-to-source on-resistance (R_{DSON}) and inductor series resistance ($R_{INDUCTOR}$), and thus it is proportional to the load current:

$$V_{DROPOUT} = I_{OUT} \times (R_{DSON} + R_{INDUCTOR}) \quad (EQ 1)$$

8.3 Shutdown

A logic low on pin SHDNN shuts down the AS1341; a logic high on SHDNN powers on the device.

In shutdown mode the supply current drops to 0.8µA to maximize battery life, and the internal P-channel MOSFET turns off to isolate the output from the input. The output capacitance and load current determine the output voltage decay rate.

Note: Pin SHDNN should not be left floating. If the shutdown feature is not used, connect SHDNN to IN.

8.4 Power-OK Output

The AS1341 provides a Power OK output (POK) that goes high-impedance when the output reaches 92.5% of its regulation point. POK goes low when the output is below 92.5% of the regulation point and the AS1341 is turned on ($IN \geq 4.5V$ and $SHDNN \geq 2.4V$). A 12kΩ to 1MΩ pullup resistor between pin POK and pin IN or pin OUT or another voltage ($\leq IN$) can provide a microprocessor logic control signal.

Note: Connect pin POK to GND when the Power-Ok feature is not used.

8.5 Thermal-Overload Protection

Integrated thermal-overload protection limits total power dissipation in the AS1341. During continuous thermal-overload conditions, when the AS1341 junction temperature exceeds $T_J = +145^\circ C$, the internal thermal sensor turns off the pass transistor, allowing the AS1341 to cool down. When the AS1341 junction temperature cools by 10°C, the thermal sensor turns the pass transistor on again resulting in a pulsed output.



9 Application Information

9.1 Adjusting Output Voltage

The AS1341 feedback input features dual-mode operation. Connect FB to GND for the 5.0V preset output voltage (see Figure 21 on page 8). Adjust the output voltage by connecting a voltage-divider from the output to GND (see Figure 22).

Figure 22. Adjustable Output Voltage Circuit

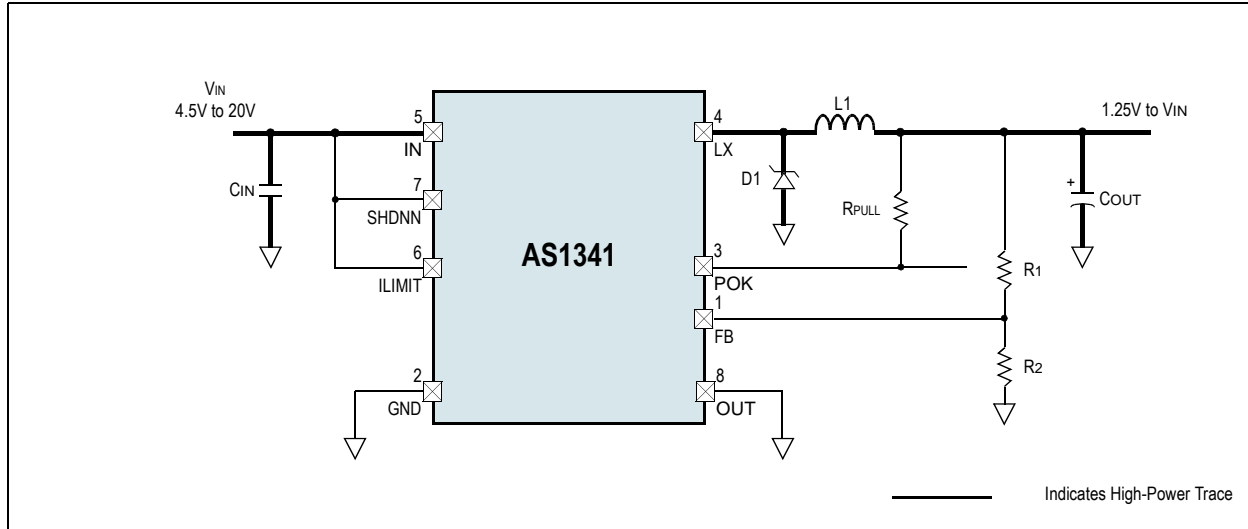

Select a value for R2 between 10k and 1MΩ.

Calculate R1 as:

$$R_1 = R_2 \cdot \left(\frac{V_{OUT}}{V_{FB}} - 1 \right) \tag{EQ 2}$$

Where:

$V_{FB} = 1.25V$.

V_{OUT} may range from 1.25V to V_{IN} .

9.2 Negative Output Voltage

V_{IN} may range from 4.5V to $(20V - V_{OUT})$. Therefore the maximum negative output voltage is -15V.

Figure 23. Adjustable Negative Output Voltage Circuit

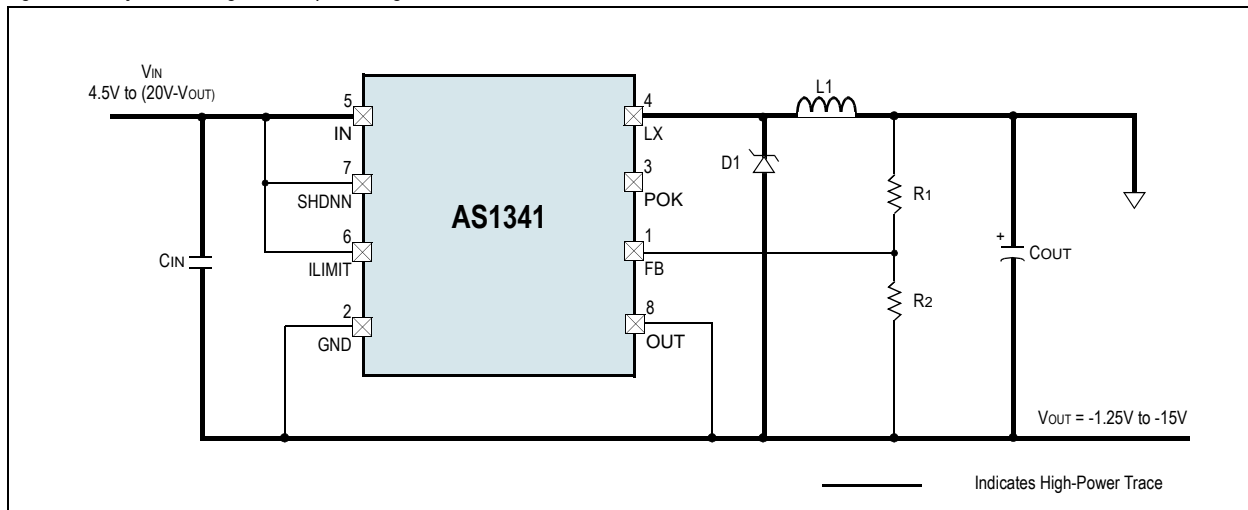



9.3 Setting Current Limit

The AS1341 adjustable peak current limit is set by connecting ILIMIT as shown in [Table 4](#).

Table 4. Setting Peak Current Limit

Current Limit	ILIMIT Connected To
700mA	GND
1400mA	IN

The current limit chosen should reflect the maximum load current. The maximum output current is half of the peak current limit. Choosing a lower current limit allows using an inductor with a lower current rating, however, it requires a higher inductance (see [Inductor Selection](#)) and does not allow for reduced inductor package size.

9.4 Inductor Selection

The AS1341 operates with a wide range of inductance values. For most applications, values between 10µH and 47µH work best with the controller's high switching frequency. Larger inductor values will reduce the switching frequency and thereby improve efficiency and EMI.

Note: The four key factors in inductor selection are inductance value, saturation rating, series resistance, and size.

The trade-off for improved efficiency is a higher output ripple and slower transient response. On the other hand, low-value inductors respond faster to transients, improve output ripple, offer smaller physical size, and minimize cost. If the inductor value is too small, the peak inductor current exceeds the current limit due to current-sense comparator propagation delay, potentially exceeding the inductor's current rating. Calculate the minimum inductance value as follows:

$$L_{MIN} = ((V_{INMAX} - V_{OUTPUT}) \times t_{ONMIN}) / I_{LXPEAK} \quad (EQ 3)$$

Where:

$t_{ONMIN} = 1\mu s$

The inductor saturation current rating must be greater than the peak switch current limit, plus the overshoot due to the 250ns current-sense comparator propagation delay. Saturation occurs when the magnetic flux density of the inductor reaches the maximum level the core can support and the inductance starts to fall. Choose an inductor with a saturation rating greater than IPEAK in the following equation:

$$I_{PEAK} = (I_{LXPEAK} + (V_{IN} - V_{OUTPUT}) \times 250ns) / L \quad (EQ 4)$$

Inductor series resistance affects both efficiency and dropout voltage (see [Dropout Voltage on page 9](#)). High series resistance limits the maximum current available at lower input voltages, and increases the dropout voltage. For optimum performance, select an inductor with the lowest possible DC resistance that fits in the allotted dimensions.

Table 5. Recommended Inductors

Part Number	L	DCR	Current Rating	Manufacturer
MSS6132-103ML	10µH	85mΩ	1.4A	Coilcraft www.coilcraft.com
LPS4018-472ML	4.7µH	125mΩ	1.8A	
MSS6132-393ML	39µH	345mΩ	0.8A	
LPS4018-223ML	22µH	360mΩ	0.7A	
CDRH6D28NP-150	15µH	62mΩ	1.4A	Sumida www.sumida.com
CDRH5D18NP-4R1	4.1µH	57mΩ	1.95A	
CDRH6D28NP-470	47µH	176mΩ	0.8A	
CDRH5D18NP-220	22µH	215mΩ	0.8A	
LQH66SN-100M03	10µH	36mΩ	1.6A	Murata www.murata.com
LQH55DN-150M03	15µH	150mΩ	1.4A	
LQH66SN-470M03	47µH	170mΩ	0.8A	
LQH55DN-470M03	47µH	400mΩ	0.8A	



9.5 Maximum Output Current

The AS1341 output current determines the regulator's switching frequency. When the converter approaches continuous mode, the output voltage falls out of regulation. For the typical application, the maximum output current is approximately:

$$I_{LOADMAX} = 1/2 \times I_{LXPEAKMIN} \quad (EQ 5)$$

For low-input voltages, the maximum on-time may be reached and the load current is limited by:

$$I_{LOAD} = (1/2 \times (V_{IN} - V_{OUT}) \times 10\mu s) / L \quad (EQ 6)$$

9.6 Output Capacitor

Choose the output capacitor to service the maximum load current with acceptable voltage ripple. The output ripple has two components: variations in the charge stored in the output capacitor with each LX pulse, and the voltage drop across the capacitor's equivalent series resistance (ESR) caused by the current into and out of the capacitor:

$$V_{RIPPLE} \cong V_{RIPPLEESR} + V_{RIPPLEC} \quad (EQ 7)$$

The output voltage ripple as a consequence of the ESR and output capacitance is:

$$V_{RIPPLEESR} = ESR \times I_{PEAK} \quad (EQ 8)$$

$$V_{RIPPLEC} = (L \times (I_{PEAK} - I_{OUTPUT})^2) / (2 \times (C_{OUT} \times V_{OUTPUT})) \times V_{IN} / (V_{IN} - V_{OUTPUT}) \quad (EQ 9)$$

Where:

I_{PEAK} is the peak inductor current (see [Inductor Selection on page 11](#)). The worst-case ripple occurs at no-load.

Equations [EQ 7](#), [EQ 8](#), and [EQ 9](#) are suitable for initial capacitor selection, but actual values should be set by testing a prototype or evaluation circuit. As a general rule, a smaller amount of charge delivered in each pulse results in less output ripple. Since the amount of charge delivered in each oscillator pulse is determined by the inductor value and input voltage, the voltage ripple increases with larger inductance, and as the input voltage decreases.

Table 6. Recommended Output Capacitor

Part Number	C	ESR	Rated Voltage	Manufacturer
T520V107M010ATE018	100 μ F	18m Ω	10V	Kemet www.kemet.com
A700V826M006ATE018	82 μ F	18m Ω	6.3V	
T520B107M006ATE040	100 μ F	40m Ω	6V	
T520A336M006ATE070	33 μ F	70m Ω	6.3V	
A700V226M006ATE028	22 μ F	28m Ω	6.3V	
510X107M020ATE040	10 μ F	40m Ω	20V	
EEFUD0J101R	100 μ F	15m Ω	6.3V	Panasonic www.panasonic.com
EEFCD0K330R	33 μ F	18m Ω	8V	
10TPB100ML	100 μ F	55m Ω	10V	Sanyo www.edc.sanyo.com
6TPB47M	47 μ F	70m Ω	6.3V	



9.7 Input Capacitor

The input filter capacitor reduces peak currents drawn from the power source and reduces noise and voltage ripple on the input caused by the circuit's switching. The input capacitor must meet the ripple-current requirement (IRMS) imposed by the switching current defined as:

$$I_{RMS} = (I_{LOAD} \times V_{OUTPUT}) / V_{IN} \times \sqrt{(4/3) \times (V_{IN} - V_{OUTPUT}) - 1} \quad (EQ 10)$$

For most applications, non-tantalum type (ceramic, aluminum, polymer, or OS-CON) are preferred due to their robustness to high in-rush currents typical of systems with low-impedance battery inputs. Alternatively, connect two (or more) smaller value low-ESR capacitors in parallel to reduce cost. Choose an input capacitor that exhibits less than +10°C temperature rise at the RMS input current for optimal circuit life.

Table 7. Recommended Input Capacitor

C	TC Code	Rated Voltage	Manufacturer
10µF	X7R	25V	Murata www.murata.com Taiyo Yuden www.t-yuden.com Kemet www.kemet.com Panasonic www.panasonic.com Sanyo www.edc.sanyo.com

9.8 Diode Selection

The current in the D1 (see Figure 22 on page 10) changes abruptly from zero to its peak value each time the LX switch turns off. To avoid excessive losses, the diode must have a fast turn-on time and a low forward voltage.

Note: Ensure that the diode peak current rating exceeds the peak current limit set by the current limit (see Setting Current Limit on page 11), and that its breakdown voltage exceeds V_{IN} . Schottky diodes are recommended.

9.9 Stable Operation

A well-designed system and selection of high-quality external components can eliminate excessive noise on pins OUT, FB, or GND, which can lead to unstable device operation. Instability typically manifests itself as grouped switching pulses with large gaps and excessive low-frequency output ripple (motorboating) during no-load or light-load conditions.

9.10 Recommended Components

Table 8. Recommended Components

Input Voltage	Output Voltage	ILIMIT	Inductor	Output Capacitor
4.5V to 20V	1.25V to 5V	High	MSS6132-103ML LQH66SN-100M03 LQH55DN-150M03 CDRH6D28NP-150	T520V107M010ATE018 A700V826M006ATE018 T520B107M006ATE040 EEFUD0J101R 10TPB100ML
4.5v to 12V			CDRH5D18NP-4R1 LPS4018-472ML	
4.5V to 20V	1.25V to 5V	Low	MSS6132-393ML CDRH6D28NP-470 LQH66SN-470M03 LQH55DN-470M03	EEFCD0K330R 6TPB47M T520A336M006ATE070 A700V226M006ATE028
4.5V to 12V			MSS6132-103ML LPS4018-223ML CDRH5D18NP-220	
6V to 20V	5V to V_{IN}	High or Low	See Inductors above	510X107M020ATE040



9.11 PC Board Layout and Grounding

High switching frequencies and large peak currents make PC board layout an important part of AS1341-based designs. Good PCB layout can avoid switching noise being introduced into the feedback path, resulting in jitter, instability, or degraded performance.

- High-power traces (see [Figure 22 on page 10](#)) should be as short and wide as possible.
- The current loops formed by the external components (C_{IN} , C_{OUT} , L1, and D1 see [Figure 22 on page 10](#)) should be as short as possible to avoid radiated noise. Connect the ground pins of these power components at a common node in a star-ground configuration.
- Separate noisy traces, such as the LX node, from the feedback network with grounded copper.
- Keep the extra copper on the PCB and integrate it into a pseudo-ground plane.
- When using external feedback, place the resistors as close to pin FB as possible to minimize noise coupling.



10 Package Drawings and Markings

Figure 24. TDFN-8 3x3mm Marking

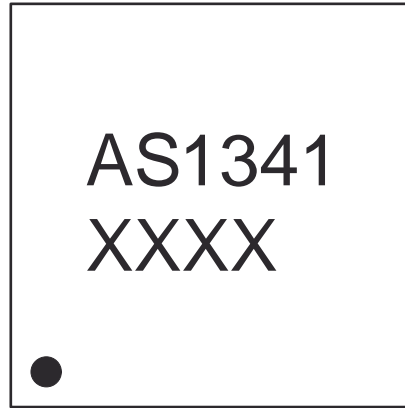

xxx - encoded Datecode



Figure 25. TDFN-8 3x3mm Package

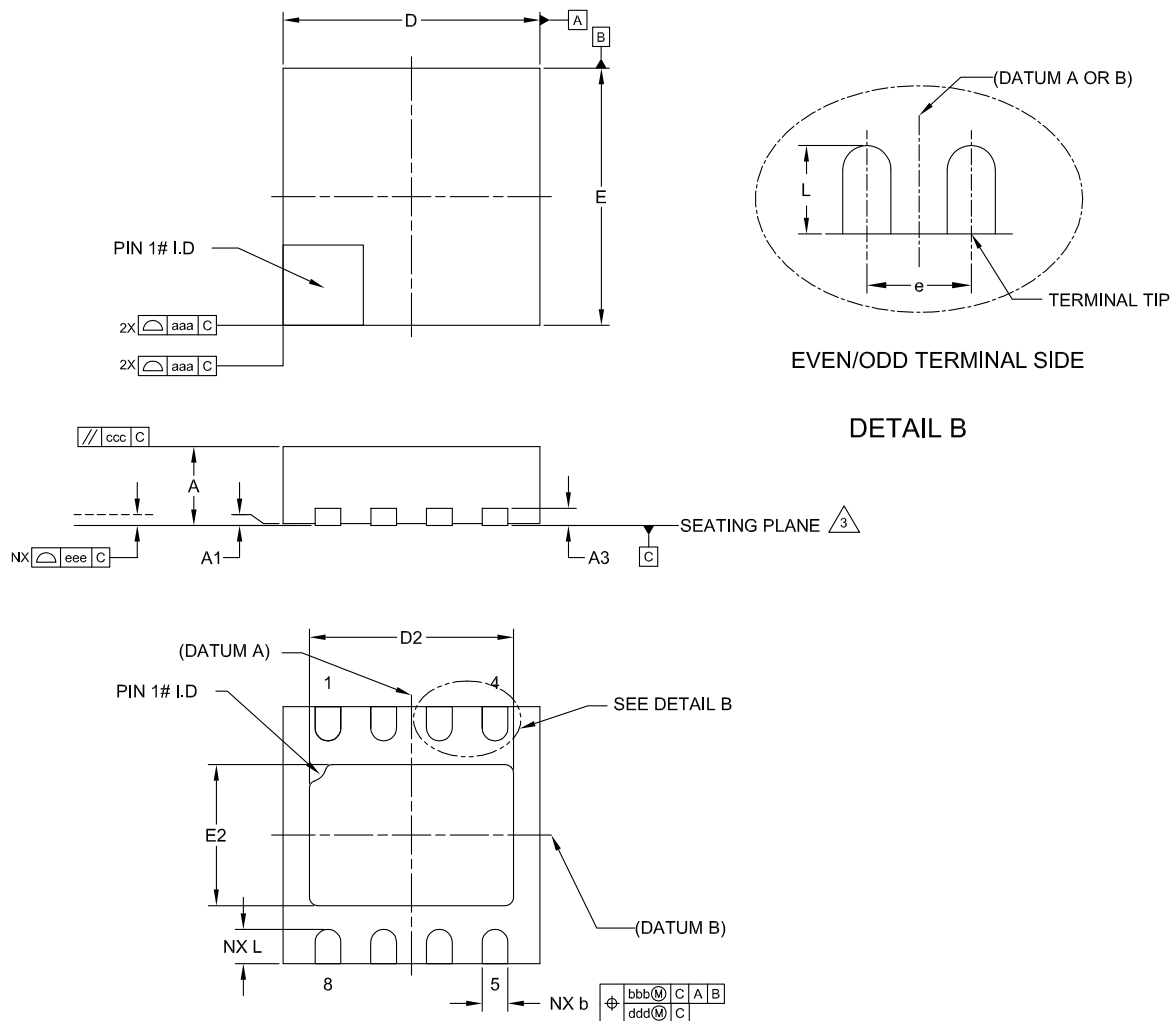

REF.	MIN	NOM	MAX
A	0.70	0.75	0.80
A1	0	0.02	0.05
A3		0.20 REF	
L	0.30	0.40	0.50
b	0.23	0.30	0.38
D		3.00 BSC	
E		3.00 BSC	
D2	2.23	2.38	2.48
E2	1.49	1.64	1.74
e		0.65 BSC	
aaa	-	0.15	-
bbb	-	0.10	-
ccc	-	0.10	-
ddd	-	0.05	-
eee	-	0.08	-
N		8	

NOTE:

1. DIMENSIONING AND TOLERANCING CONFORM TO ASME Y14.5M-1994.
2. ALL DIMENSIONS ARE IN MILLIMETERS. ANGELS ARE IN DEGREES.
3. COPLANARITY APPLIES TO THE EXPOSED HEAT SLUG AS WELL AS THE TERMINAL.
4. RADIUS ON TERMINAL IS OPTIONAL.
5. N IS THE TOTAL NUMBER OF TERMINALS.



11 Ordering Information

The device is available as the standard products shown in [Table 9](#).

Table 9. Ordering Information

Ordering Code	Marking	Description	Delivery Form		Package
AS1341-BTDT-1k	1341	20V, 600mA, 100% Duty Cycle, Step-Down Converter	Tape and Reel	1000 pcs	TDFN-8 3x3mm
AS1341-BTDT-6k	1341	20V, 600mA, 100% Duty Cycle, Step-Down Converter	Tape and Reel	6000 pcs	TDFN-8 3x3mm

Note: All products are RoHS compliant and ams green.

Buy our products or get free samples online at ICdirect: <http://www.ams.com/ICdirect>

Technical Support is found at <http://www.ams.com/Technical-Support>

For further information and requests, please contact us <mailto:sales@ams.com>
or find your local distributor at <http://www.ams.com/distributor>



Copyrights

Copyright © 1997-2010, ams AG, Tobelbaderstrasse 30, 8141 Unterpemstaetten, Austria-Europe. Trademarks Registered ®. All rights reserved. The material herein may not be reproduced, adapted, merged, translated, stored, or used without the prior written consent of the copyright owner.

All products and companies mentioned are trademarks or registered trademarks of their respective companies.

Disclaimer

Devices sold by ams AG are covered by the warranty and patent indemnification provisions appearing in its Term of Sale. ams AG makes no warranty, express, statutory, implied, or by description regarding the information set forth herein or regarding the freedom of the described devices from patent infringement. ams AG reserves the right to change specifications and prices at any time and without notice. Therefore, prior to designing this product into a system, it is necessary to check with ams AG for current information. This product is intended for use in normal commercial applications. Applications requiring extended temperature range, unusual environmental requirements, or high reliability applications, such as military, medical life-support or life-sustaining equipment are specifically not recommended without additional processing by ams AG for each application. For shipments of less than 100 parts the manufacturing flow might show deviations from the standard production flow, such as test flow or test location.

The information furnished here by ams AG is believed to be correct and accurate. However, ams AG shall not be liable to recipient or any third party for any damages, including but not limited to personal injury, property damage, loss of profits, loss of use, interruption of business or indirect, special, incidental or consequential damages, of any kind, in connection with or arising out of the furnishing, performance or use of the technical data herein. No obligation or liability to recipient or any third party shall arise or flow out of ams AG rendering of technical or other services.



Contact Information

Headquarters

ams AG
Tobelbaderstrasse 30
A-8141 Unterpemstaetten, Austria

Tel: +43 (0) 3136 500 0
Fax: +43 (0) 3136 525 01

For Sales Offices, Distributors and Representatives, please visit:

<http://www.ams.com/contact>