

### Features

- Temperature-compensated: 30 ppm/°C
- Trimmed bandgap reference
- Internal amplifier with 150 mA capability
- Multiple temperature ranges
- Low frequency dynamic output impedance: < 150 mΩ
- Low output noise
- Robust ESD protection

### Description

The AS431 is a three-terminal adjustable shunt regulator providing a highly accurate bandgap reference. The adjustable shunt regulator is ideal for a wide variety of linear applications that can be implemented using external components to obtain adjustable currents and voltages.

In the standard shunt configuration, the combination of low temperature coefficient (TC), sharp turn-on characteristics, low output impedance and programmable output voltage make this precision reference a perfect zener diode replacement.

The AS431 precision adjustable shunt reference is offered in four bandgap tolerances: ±0.25%, ±0.5%, ±1.0%, and ±2.0%.

### Pin Configuration — Top view

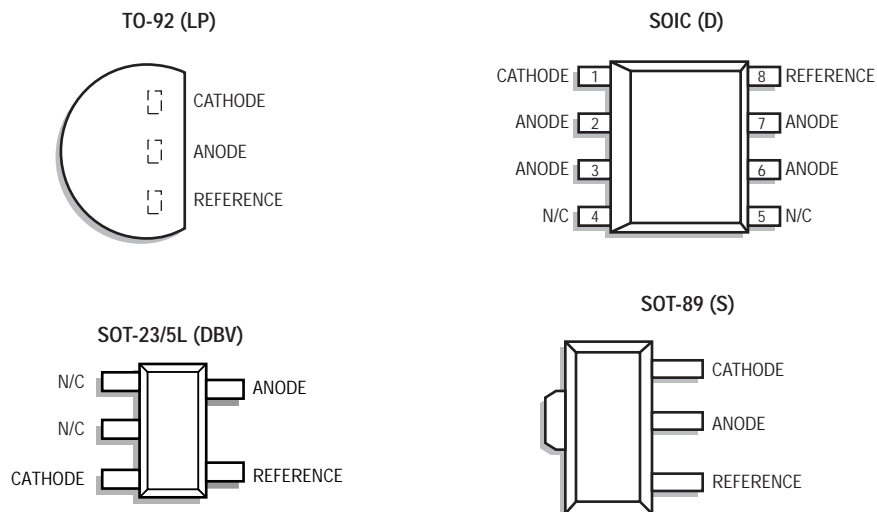

### Ordering Information

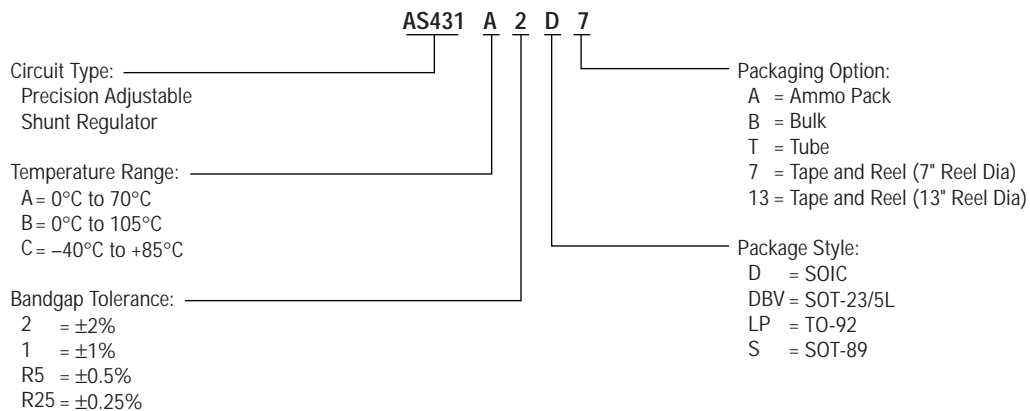

## Functional Block Diagram

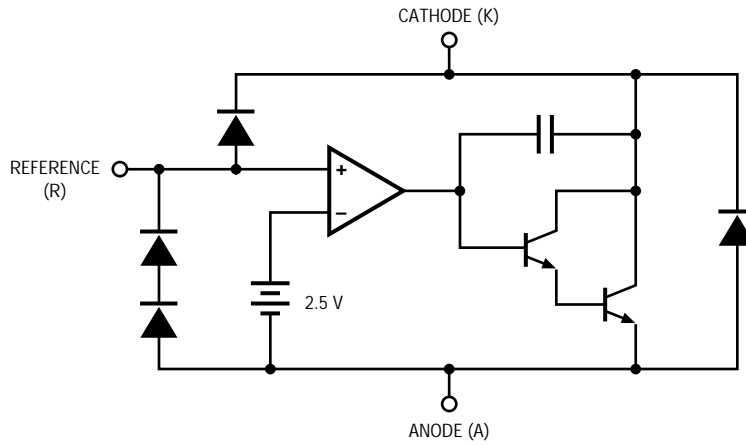

## Absolute Maximum Ratings

Parameter	Symbol	Rating	Units
Cathode-Anode Reverse Breakdown	$V_{KA}$	37	V
Anode-Cathode Forward Current	$I_{AK}$	1	A
Operating Cathode Current	$I_{KA}$	250	mA
Reference Input Current	$I_{REF}$	10	mA
Continuous Power at 25°C	$P_D$		
TO-92		775	mW
8L SOIC		750	mW
SOT-89		1000	mW
SOT-23/5L		200	mW
Junction Temperature	$T_J$	150	°C
Storage Temperature	$T_{STG}$	-65 to 150	°C
Lead Temperature, Soldering 10 Seconds	$T_L$	300	°C

Stresses greater than those listed under ABSOLUTE MAXIMUM RATINGS may cause permanent damage to the device. This is a stress rating only and functional operation of the device at these or any other conditions above those indicated in the operational sections of this specification is not implied. Exposure to absolute maximum rating conditions for extended periods may affect reliability.

## Recommended Conditions

Parameter	Symbol	Rating	Unit
Cathode Voltage	$V_{KA}$	$V_{REF}$ to 20	V
Cathode Current	$I_K$	10	mA

## Typical Thermal Resistances

Package	$\theta_{JA}$	$\theta_{JC}$	Typical Derating
TO-92	160°C/W	80°C/W	6.3 mW/°C
SOIC	175°C/W	45°C/W	5.7 mW/°C
SOT-89	110°C/W	8°C/W	9.1 mW/°C
SOT-23/5L	575°C/W	150°C/W	1.7 mW/°C

### Electrical Characteristics

Electrical Characteristics are guaranteed over full junction temperature range (0 to 105°C). Ambient temperature must be derated based on power dissipation and package thermal characteristics. The conditions are:  $V_{KA} = V_{REF}$  and  $I_K = 10$  mA unless otherwise stated.

Parameter	Symbol	Test Condition	AS431 (0.25%)			AS431 (0.5%)			Unit	Test Circuit
			Min.	Typ.	Max.	Min.	Typ.	Max.		
Reference Voltage	$V_{REF}$	$T_A = 25^\circ\text{C}$	2.496	2.503	2.509	2.490	2.503	2.515	V	1
		Over temp.	2.475		2.530	2.469		2.536	V	1
$\Delta V_{REF}$ with Temp*	TC			0.07	0.20		0.07	0.20	mV/°C	1
Ratio of Change in $V_{REF}$ to Cathode Voltage	$\frac{\Delta V_{REF}}{\Delta V_K}$	$V_{REF}$ to 10 V	-2.7	-1.0		-2.7	-1.0		mV/V	2
		10 V to 36 V	-2	-0.4	0.3	-2	-0.4	0.3		
Reference Input Current	$I_{REF}$			0.7	4		0.7	4	$\mu\text{A}$	2
$I_{REF}$ Temp Deviation	$\Delta I_{REF}$	Over temp.		0.4	1.2		0.4	1.2	$\mu\text{A}$	2
Min $I_K$ for Regulation	$I_{K(\text{min})}$			0.4	1		0.4	1	mA	1
Off State Leakage	$I_{K(\text{off})}$	$V_{REF} = 0$ V, $V_{KA} = 36$ V		0.04	250		0.04	250	nA	3
Dynamic Output Impedance	$Z_{KA}$	$f \leq 1$ kHz $I_K = 1$ to 150 mA		0.15	0.5		0.15	0.5	$\Omega$	1

Parameter	Symbol	Test Condition	AS431 (1.0%)			AS431 (2.0%)			Unit	Test Circuit
			Min.	Typ.	Max.	Min.	Typ.	Max.		
Reference Voltage	$V_{REF}$	$T_A = 25^\circ\text{C}$	2.470	2.495	2.520	2.440	2.490	2.550	V	1
		Over temp.	2.449		2.541	2.430		2.569	V	1
$\Delta V_{REF}$ with Temp*	TC			0.07	0.20		0.07	0.20	mV/°C	1
Ratio of Change in $V_{REF}$ to Cathode Voltage	$\frac{\Delta V_{REF}}{\Delta V_K}$	$V_{REF}$ to 10 V	-2.7	-1.0		-2.7	-1.0		mV/V	2
		10 V to 36 V	-2	-0.4	0.3	-2	-0.4	0.3		
Reference Input Current	$I_{REF}$			0.7	4		0.7	4	$\mu\text{A}$	2
$I_{REF}$ Temp Deviation	$\Delta I_{REF}$	Over temp.		0.4	1.2		0.4	1.2	$\mu\text{A}$	2
Min $I_K$ for Regulation	$I_{K(\text{min})}$			0.4	1		0.4	1	mA	1
Off State Leakage	$I_{K(\text{off})}$	$V_{REF} = 0$ V, $V_{KA} = 36$ V		0.04	250		0.04	250	nA	3
Dynamic Output Impedance	$Z_{KA}$	$f \leq 1$ kHz $I_K = 1$ to 150 mA		0.15	0.5		0.15	0.5	$\Omega$	1

\*Calculating Average Temperature Coefficient (TC). Refer to following page.

Average Temperature Coefficient

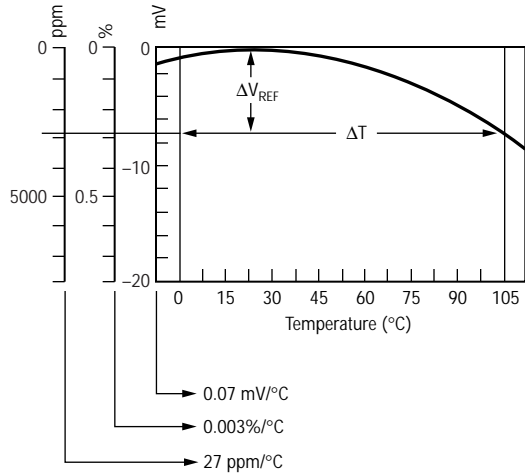

- TC in mV/°C =  $\frac{\Delta V_{REF} \text{ (mV)}}{\Delta T_A}$
- TC in %/°C =  $\frac{\left(\frac{\Delta V_{REF}}{V_{REF} \text{ at } 25^\circ\text{C}}\right) \times 100}{\Delta T_A}$
- TC in ppm/°C =  $\frac{\left(\frac{\Delta V_{REF}}{V_{REF} \text{ at } 25^\circ\text{C}}\right) \times 10^6}{\Delta T_A}$

Test Circuits

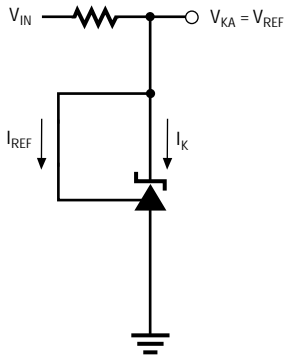

Figure 1a. Test Circuit 1

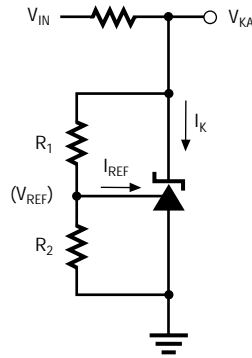

Figure 1b. Test Circuit 2

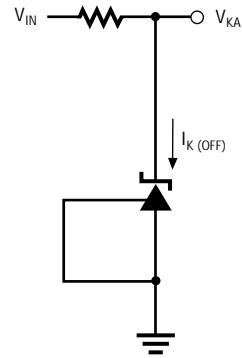

Figure 1c. Test Circuit 3

Typical Performance Curves

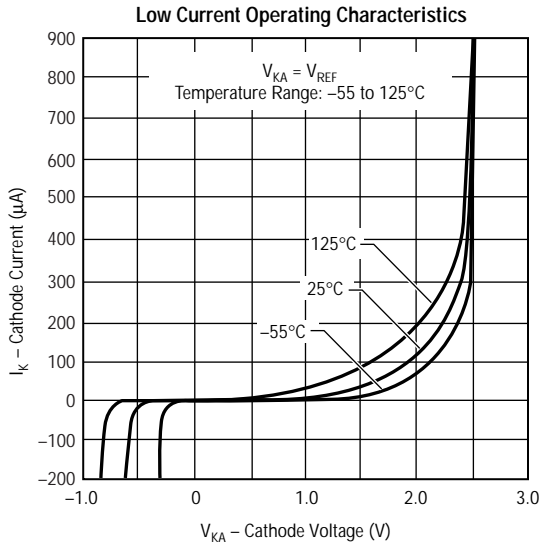

Figure 2

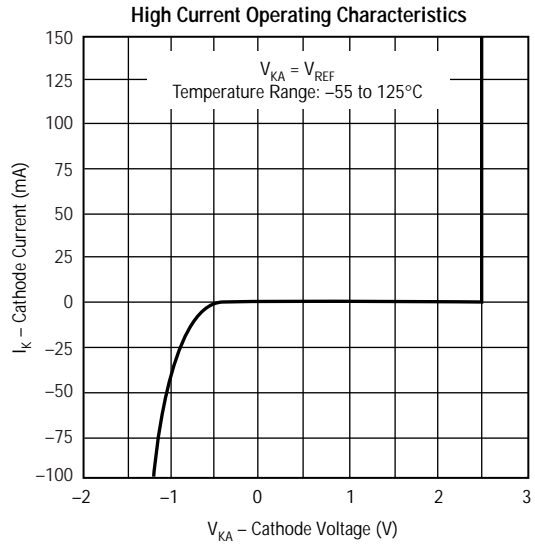

Figure 3

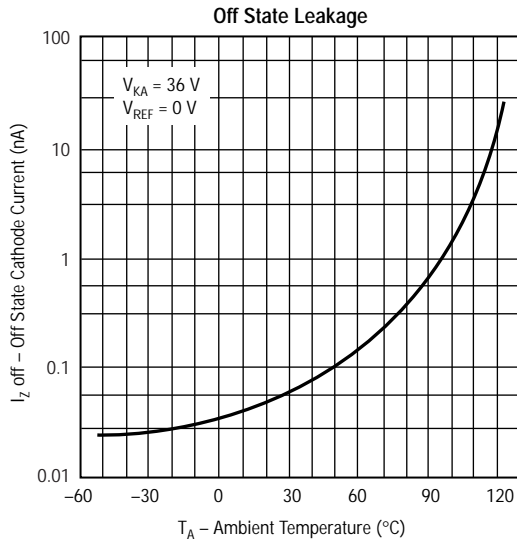

Figure 4

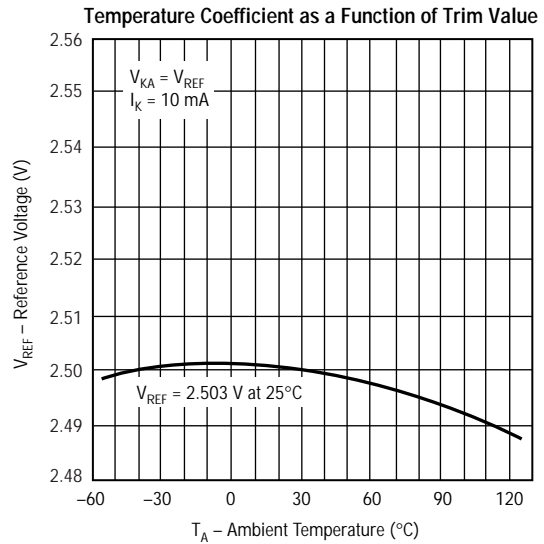

Figure 5

Typical Performance Curves

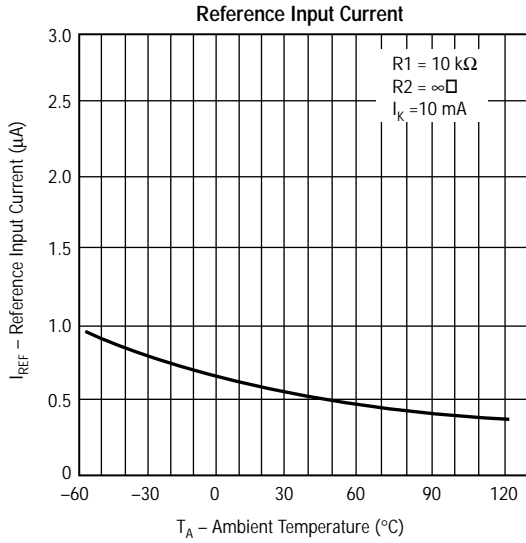

Figure 6

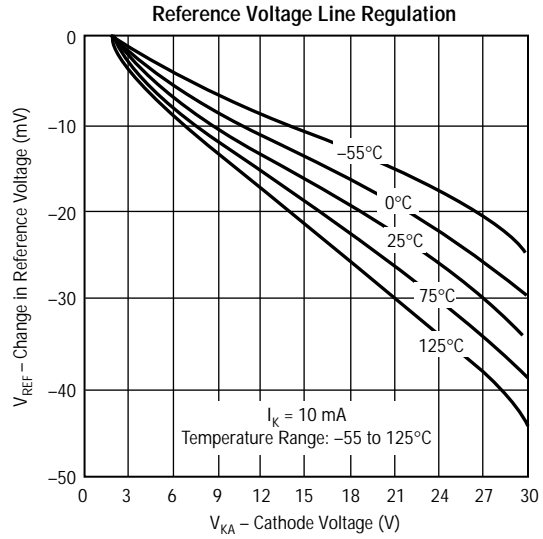

Figure 7

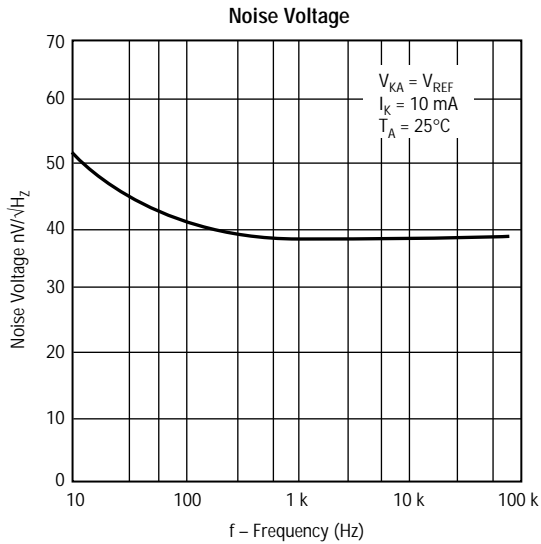

Figure 8

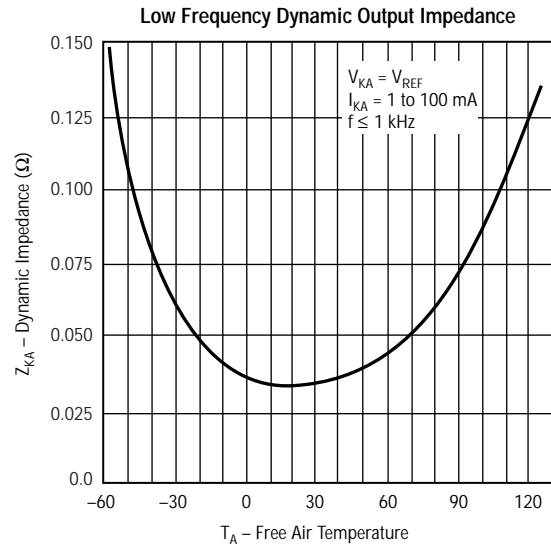

Figure 9

Typical Performance Curves

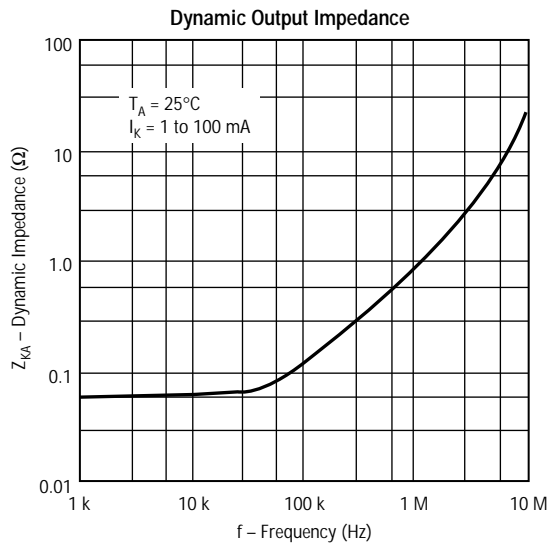

Figure 10

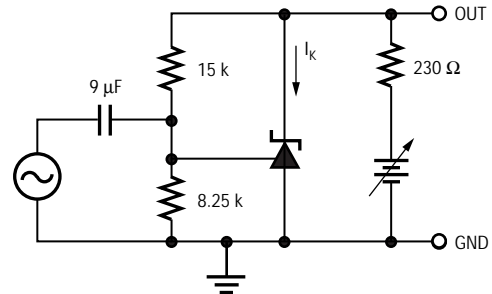
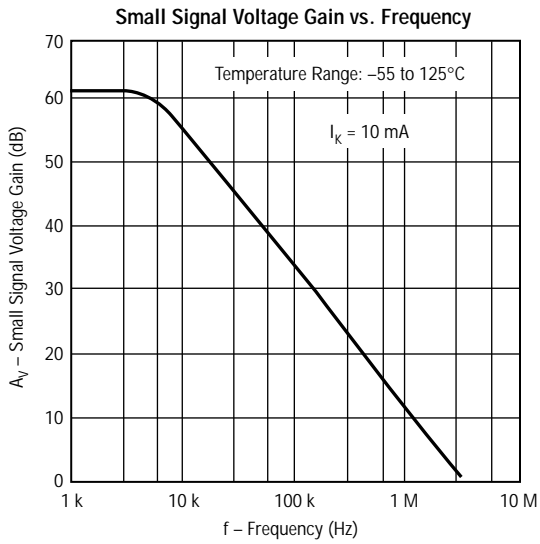

Figure 11

Typical Performance Curves

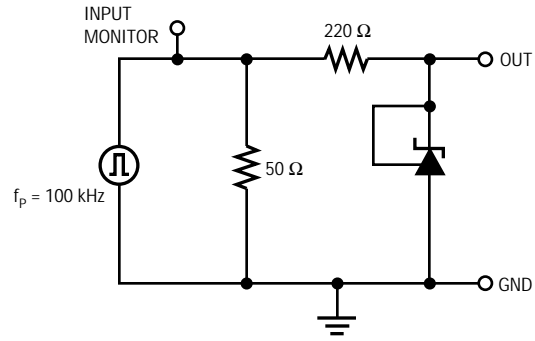
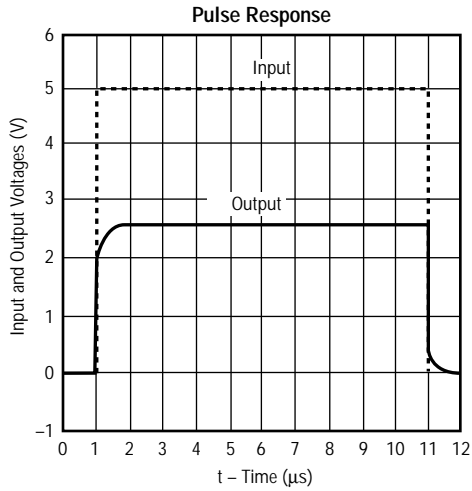

Figure 12

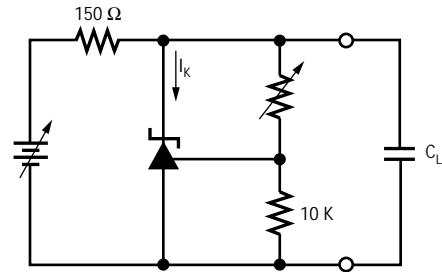
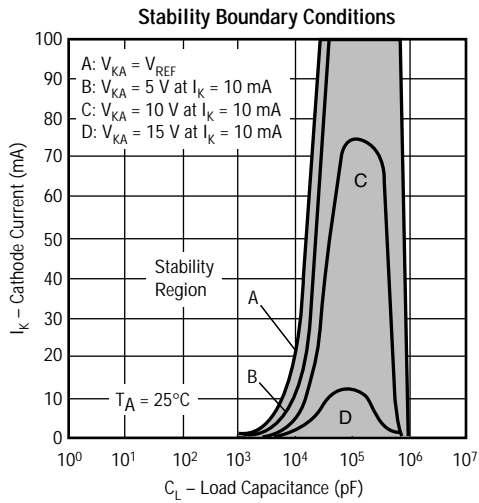

Figure 13