

AS4420 / AS4429

FEATURES

- Latch Up Protected >1.5A
- Logic Input Swing Negative 5V
- ESD 4kV
- Matched Rise and Fall Times 20ns

APPLICATIONS

- Motor Controls
- Switch-Mode Power Supplies
- Pulse Transformer Driver
- Class D Switching Amplifiers

DESCRIPTION

The AS4420 and AS4429 family operate over 4.5V to 18V, can withstand high current peaking of 6A and have matched rise and fall times under 25ns. The product has been designed utilizing Calogic's rugged CMOS process with protection for latch up and ESD. The product is available in inverting (AS4429) and noninverting (AS4420) configurations.

ORDERING INFORMATION

Part#	Logic	Package	Temperature Range
AS4420P	Noninverting	8-Pin PDIP	-40°C to +85°C
AS4420S	Noninverting	8-Pin SOIC	-40°C to +85°C
AS4429P	Inverting	8-Pin PDIP	-40°C to +85°C
AS4429S	Inverting	8-Pin SOIC	-40°C to +85°C

FUNCTIONAL DIAGRAM AND PIN CONFIGURATIONS

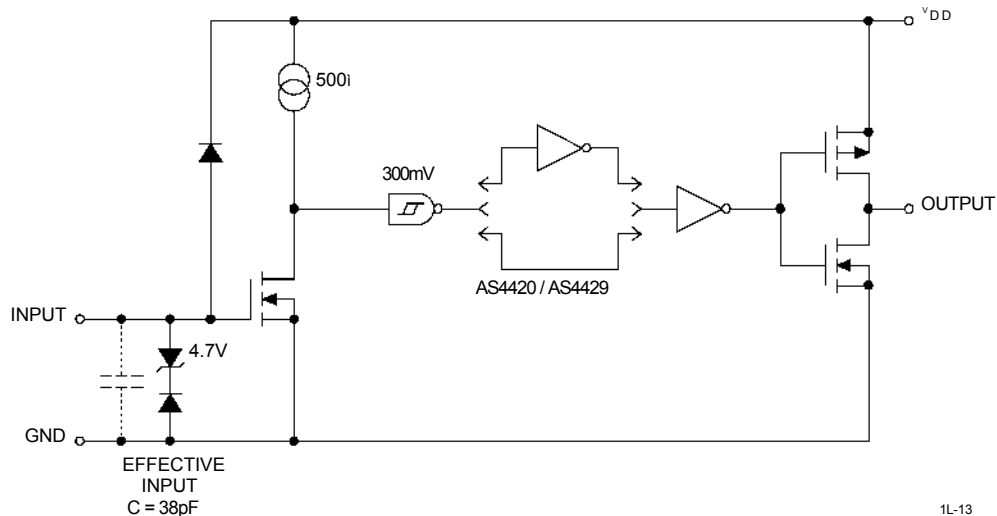
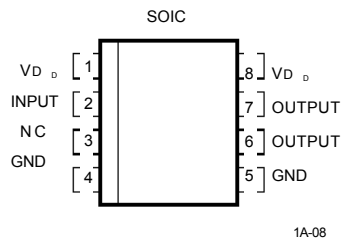
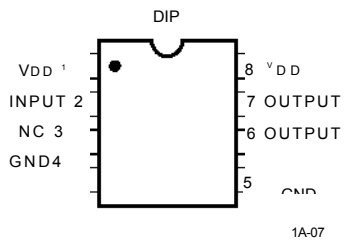

ABSOLUTE MAXIMUM RATINGS

Supply Voltage	+20V
Input Voltage	-5V to >V _{DD}
Input Current (V _{IN} > V _{DD})	50mA
Power Dissipation, T _A < 25°C	
PDIP	1W
SOIC	500mW
Derating Factors (To Ambient)	
PDIP	8mW/°C
SOIC	4mW/°C
Storage Temperature Range	-55°C to +150°C
Operating Temperature (Chip)	+150°C
Operating Temperature Range (Ambient)	
C Version	0°C to +70°C
E Version	-40°C to +85°C
Lead Temperature (Soldering, 10 sec)	+300°C

Static-sensitive device. Unused devices must be stored in conductive material. Protect devices from static discharge and static fields. Stresses above those listed under "Absolute Maximum Ratings" may cause permanent damage to the device. These are stress ratings only and functional operation of the device at these or any other conditions above those indicated in the operation sections of the specifications is not implied. Exposure to absolute maximum rating conditions for extended-periods may affect device reliability.

ELECTRICAL CHARACTERISTICS: T_A = +25°C with 4.5V < V_{DD} < 18V, unless otherwise specified.

SYMBOL	PARAMETER	MIN	TYP	MAX	UNIT	TEST CONDITIONS
INPUT						
V _{IH}	Logic 1 High Input Voltage	2.4	1.8		V	
V _{IL}	Logic 0 Low Input Voltage		1.3	0.8	V	
V _{IN (Max)}	Input Voltage Range	-5		V _{DD} +0.3	V	
I _{IN}	Input Current	-10		10	A	0V < V _{IN} < V _{DD}
OUTPUT						
V _{OH}	High Output Voltage	V _{DD} -0.025			V	See Figure 1
V _{OL}	Low Output Voltage			0.025	V	See Figure 1
R _O	Output Resistance, High		2.1	2.8		I _{OUT} = 10mA, V _{DD} = 18V
R _O	Output Resistance, Low		1.5	2.5		I _{OUT} = 10mA, V _{DD} = 18V
I _{PK}	Peak Output Current		6		A	V _{DD} = 18V (See Figure 5)
I _{REV}	Latch-Up Protection Withstand Reverse Current				> 1 . 5 t A	Duty Cycle < 2% < 300iA
SWITCHING TIME (Note 1)						
t _R	Rise Time		25	35	ns	Figure 1, C _L = 2500pF
t _F	Fall Time		25	35	ns	Figure 1, C _L = 2500pF
t _{D1}	Delay Time		20	40	ns	Figure 1
t _{D2}	Delay Time		20	40	ns	Figure 1
POWER SUPPLY						
I _S	Power Supply Current		1 55	1.5 150	mA A	V _{IN} = 3V V _{IN} = 0V
V _{DD}	Operating Input Voltage	4.5		18	V	

ELECTRICAL CHARACTERISTICS:

Measured over operating temperature range with 4.5V ~ V_{DD} ~ 18V, unless otherwise specified.

SYMBOL	PARAMETER	MIN	TYP	MAX	UNIT	TEST CONDITIONS
INPUT						
V _{IH}	Logic 1 High Input Voltage	2.4			V	
V _{IL}	Logic 0 Low Input Voltage			0.8	V	
V _{IN (Max)}	Input Voltage Range	-5		V _{DD} +0.3	V	
I _{IN}	Input Current	-10		10	LA	0V ~ V _{IN} ~ V _S
OUTPUT						
V _{OH}	High Output Voltage	V _{DD} -0.025			V	See Figure 1
V _{OL}	Low Output Voltage			0.025	V	See Figure 1
R _o	Output Resistance, High		3	5		I _{OUT} = 10mA, V _{DD} = 18V
R _o	Output Resistance, Low		2.3	5	Ω I _{OUT}	= 10mA, V _{DD} = 18V
SWITCHING TIME (Note 1)						
t _R	Rise Time		32	60	ns	Figure 1, C _L = 2500pF
t _F	Fall Time		34	60	ns	Figure 1, C _L = 2500pF
t _{D1}	Delay Time		20	50	ns	Figure 1
t _{D2}	Delay Time		20	50	ns	Figure 1
POWER SUPPLY						
I _S	Power Supply Current		1 60	3 400	mA L	V _{IN} = 3V V _{IN} = 0V
V _{DD}	Operating Input Voltage	4.5		18	V	

Note: 1. Switching times guaranteed by design.

FIGURE 1. SWITCHING TIME TEST CIRCUIT

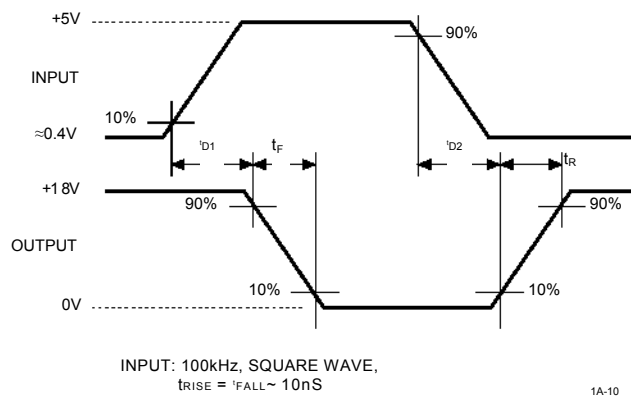
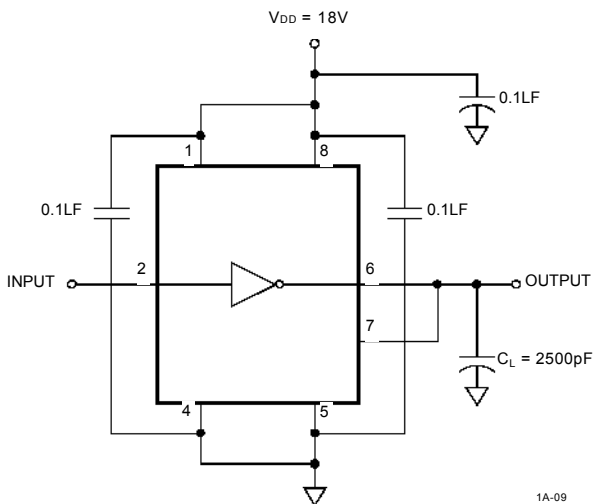

1A-10

TYPICAL CHARACTERISTICS CURVES

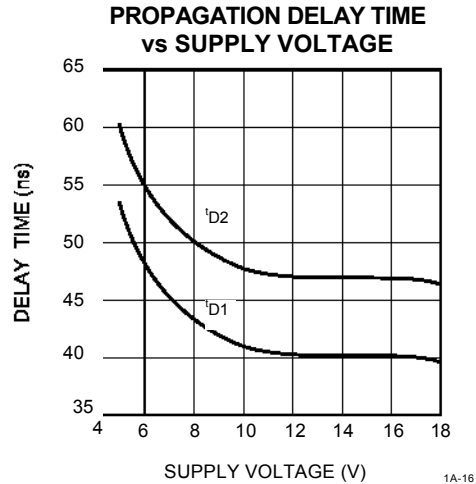
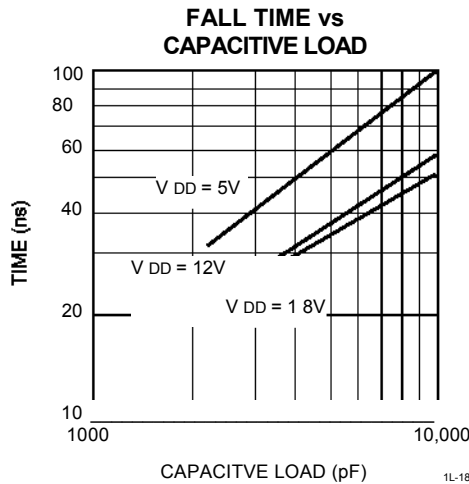
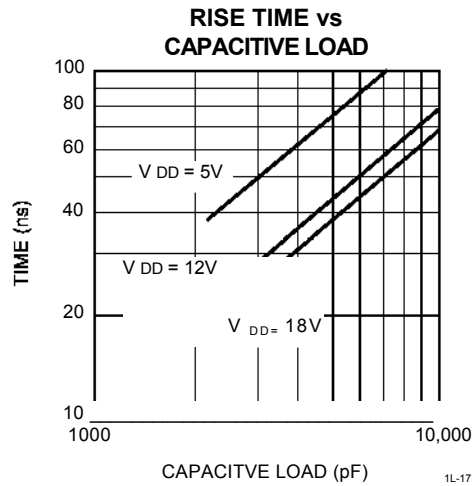
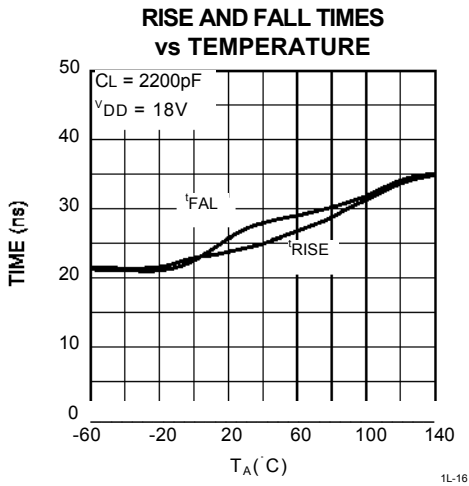
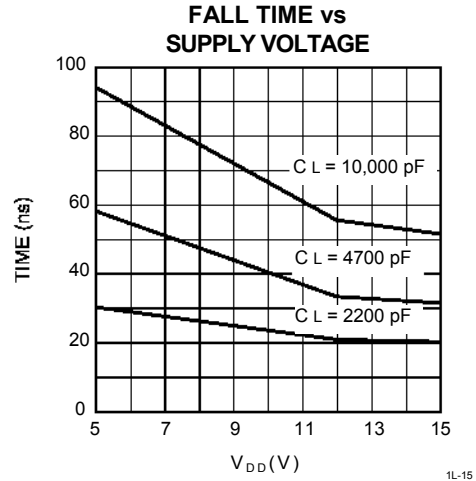
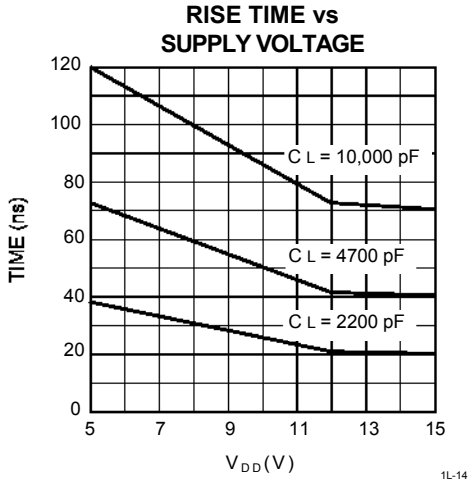

TYPICAL CHARACTERISTICS CURVES (Cont.)

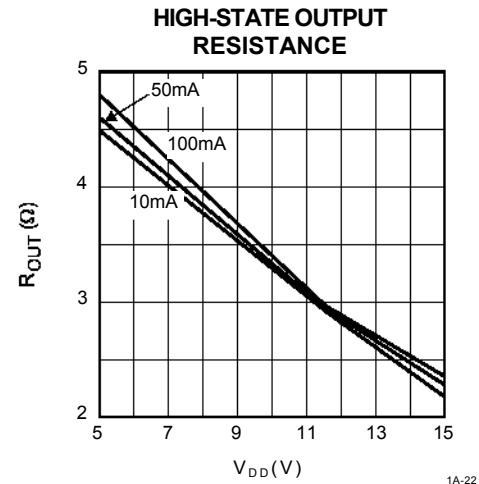
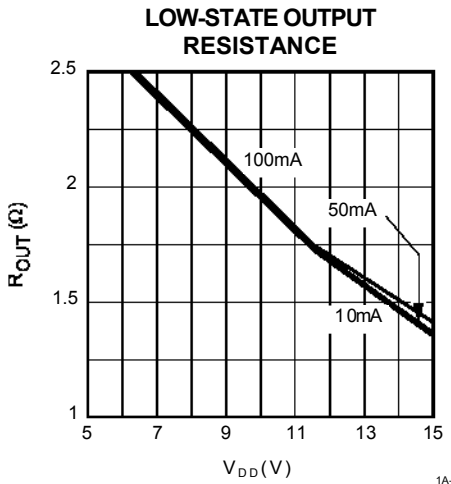
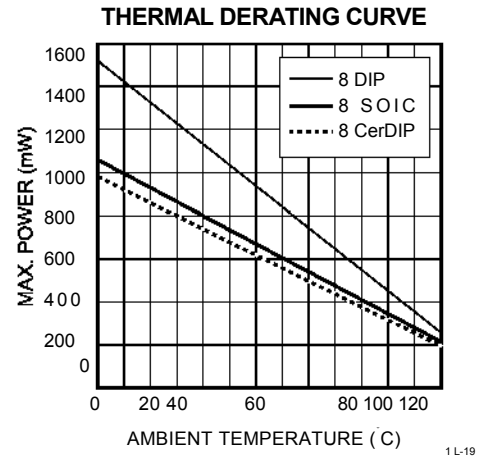
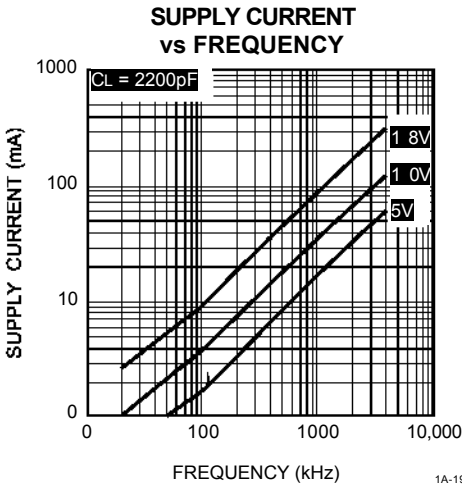
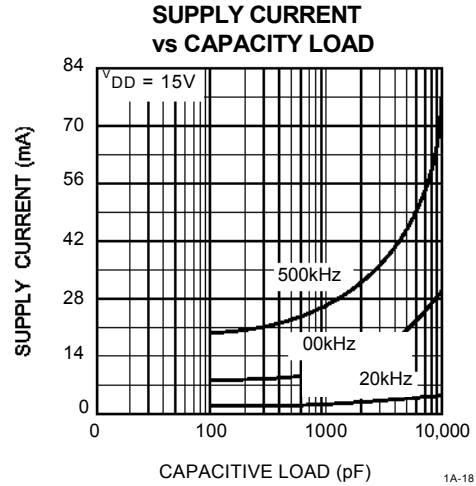
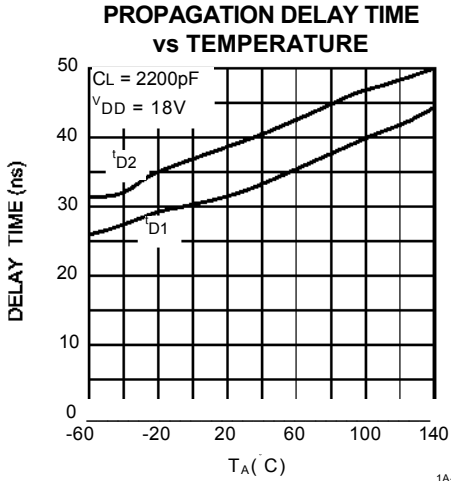

TYPICAL CHARACTERISTICS CURVES (Cont.)

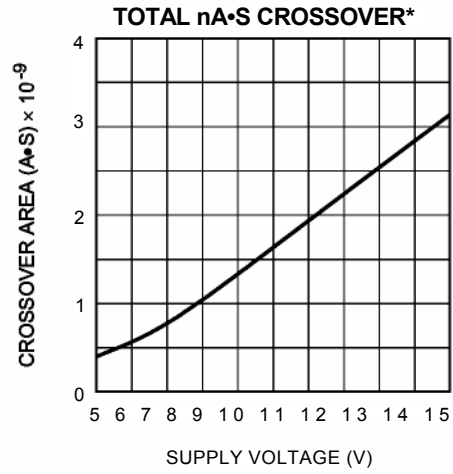
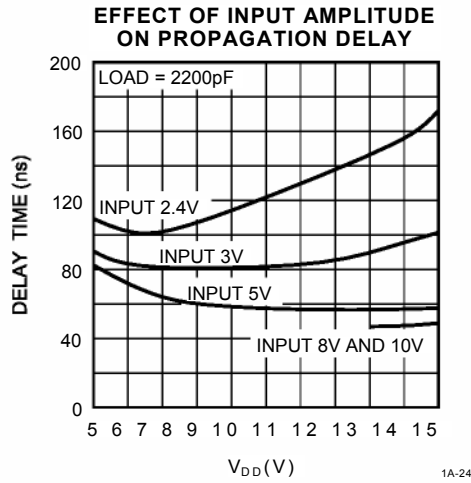

* The values on this graph represent the loss seen by the driver during one complete cycle. For a single transition, divide the value by 2.

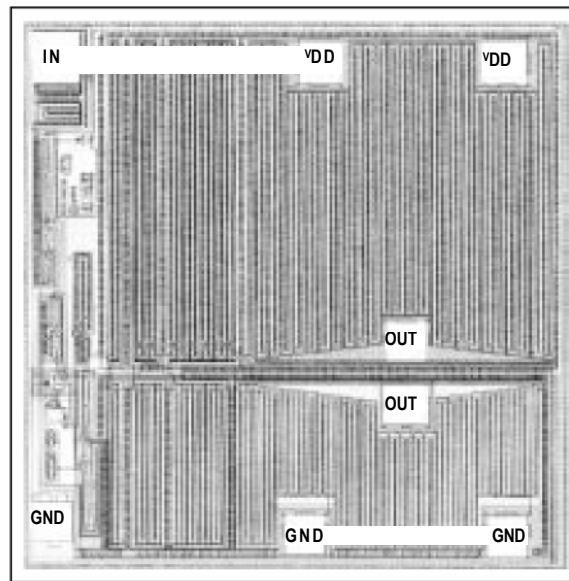

DIE SIZE 76x77 (mm)