



austriamicrosystems AG

is now

ams AG

The technical content of this austriamicrosystems datasheet is still valid.

Contact information:

Headquarters:

ams AG

Tobelbaderstrasse 30

8141 Unterpremstaetten, Austria

Tel: +43 (0) 3136 500 0

e-Mail: ams_sales@ams.com

Please visit our website at www.ams.com

High precision voltage and current measurement sensor interface

1 Features

- 16 bits resolution
- Differential inputs
- Single + 5V supply
- Low power 15 mW
- SOIC16 package
- Self- and system-calibration with auto-calibration on power up
- 16 kHz maximum sampling frequency
- Internal temperature measurement
- Internal factory trimmed precision reference
- Programmable current sources
- Digital comparator
- Active wake-up
- PGA gains 1, 6, 24, 50, 100
- Zero offset
- Zero offset TC
- Extremely low noise
- Internal oscillator with comparator for active wake up
- 3-wire serial interface, μ P compatible
- Temperature range -40 to $+125$ °C
- Individual 24-bit serial number

2 Applications

- Battery management for automotive systems
- Power management
- mV/ μ V-meter
- High-precision voltage and current measurement

3 General description

The AS8501 is a complete, low power data acquisition system for very small signals (i.e. voltages from shunt resistors, thermocouples) that operates on a single 5 V power supply. The chip powers up with a set of default conditions at which time it can be operated as a read-only-converter. Reprogramming is at any time possible by just writing into two internal registers via the serial interface.

The AS8501 has four ground referring inputs which can be switched separately to the internal PGA. Two input channels can also be operated as a fully differential ground free input. The system can measure both positive and negative input signals.

The PGA amplification ranges from 6 to 100 which enables the system to measure signals from 7mV to 120 mV full scale range with high accuracy, linearity and speed.

The chip contains a high precision bandgap reference and an active offset compensation that makes the system offset free (better than 0,5 μ V) and the offset-TC value negligible. The built-in programmable digital filter allows an effective noise suppression if the high speed is not necessary in the application. The input noise density is only $35 \text{ nV} / \sqrt{\text{Hz}}$ and due to

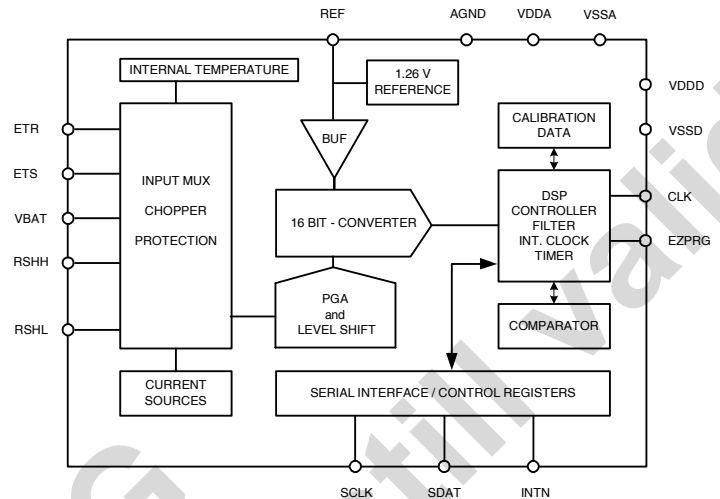

Figure 1: Functional Block Diagram

the high internal chopping frequency the system is free of $1/f$ -noise down to DC. The 0-10 Hz noise is typical below $1 \mu\text{V}$ i.e. as good or better than any other available chopper amplifier.

For high speed synchronous measurements the chip can run in an automatic switching mode between two input channels with pre-programmed parameter sets.

The circuit has been optimised for the application in battery management systems in automotive systems. As a front end data acquisition system it allows an high quality measurement of current, voltage and temperature of the battery.

With a high quality $100 \mu\Omega$ resistor the system can handle the starter current of up to 1500 A, a continuous current of ± 300 A as well as the very low idle current of a few mA in the standby mode.

For external temperature measurement the chip can use a wide variety of different temperature sensors such as RTD, PTC, NTC, thermocouples or even diodes or transistors. A built-in programmable current source can be switched to any input and activate these sensors without the need of other external components.

The measurement of the chip temperature with the integrated internal temperature sensor allows in addition the temperature compensation of sensitive parameters which increases the total accuracy considerably.

Sensor specific data can be stored in the internal Zener-Zap memory and are used to calibrate each measurement in the internal data processing unit before transmission to the external μC via the serial SDI interface.

The flexibility of the system is further increased by a digital comparator that can be assigned to any measured property (current, voltage, temperature) and an active wake-up in the sleep-mode. All analog input-terminals can be checked for wire break via the SDI-interface.

CONTENTS

1	FEATURES	1
2	APPLICATIONS	1
3	GENERAL DESCRIPTION	1
4	PIN FUNCTION DESCRIPTION FOR SOIC 16 PACKAGE	3
5	ABSOLUTE MAXIMUM RATINGS	4
6	ELECTRICAL CHARACTERISTICS	5
7	FUNCTIONAL DESCRIPTION	9
7.1	POWER ON RESET	9
7.2	ANALOG PART, GENERAL DESCRIPTION	9
7.2.1	Reference voltage	10
7.2.2	Current sources	11
7.2.3	Internal temperature sensor	12
7.3	DIGITAL PART	12
7.3.1	Sampling rate	12
7.3.2	Calibration	13
7.4	MODES OF OPERATION	13
7.5	REGISTER DESCRIPTION	15
7.5.1	OPM operation mode register (4 bits)	16
7.5.2	CRG general configuration register (28 bits)	16
7.5.3	CRA measurement channel A configuration register (17 bits)	17
7.5.4	CRB measurement channel B configuration register (17 bits)	19
7.5.5	ZZR Zener-Zap register (188 bits)	20
7.5.6	CAR calibration register (110 bits)	22
7.5.7	TRR trimming register (20 bits)	22
7.5.8	THR alarm (Wake-up) threshold register (17 bits)	25
7.5.9	MSR measurement result register (18 bits)	25
8	DIGITAL INTERFACE DESCRIPTION	25
8.1	CLK	25
8.2	INTN	25
8.3	SDI BUS OPERATION	26
8.4	DATA TRANSFERS	27
8.5	SDI BUS TIMING	28
8.6	SDI ACCESS TO OTP MEMORY	29
8.6.1	ZZR register bit mapping	29
8.6.2	Stored ZZR-register mapping	33
9	GENERAL APPLICATION HINTS	34
9.1	GROUND CONNECTION, ANALOG COMMON	34
9.2	THERMAL EMF	34
9.3	NOISE CONSIDERATIONS	35
9.4	SHIELDING, GUARDING	35
10	TYPICAL PERFORMANCE CHARACTERISTICS	36
11	PACKAGE DIMENSIONS	38
12	REVISION HISTORY	38
13	ORDERING INFORMATION	38
14	CONTACT	39
14.1	HEADQUARTERS	39
14.2	SALES OFFICES	39

4 PIN function description for SOIC 16 package

PIN	Name	description	Comment
1	RSHL	analog input from shunt resistor low side	analog common for VBAT, ETS and ETR; return for internal current source
2	RSHH	analog input from shunt resistor high side	
3	ETS	analog input with reference to RSHL analog input for differential input ETS-VBAT analog output for current-source	
4	VBAT	analog input with reference to RSHL analog input for differential input ETS-VBAT analog output for current-source	
5	VSS	0V-power supply for analog part	
6	EZPRG	digital power input for programming Zener fuses.	This input must be open or connected to VDDD. It is not intended, that OTP content is modified by the user.
7	VSSD	0V-power supply and ground reference point for digital part	
8	CLK	digital input for external clock, master clock input	external clock typical 8.192 MHz; during MWU-mode external connection must be high impedance or connected to VDDD to reduce current consumption
9	SCLK	serial port clock input for SDI-port	the user must provide a serial clock on this input
10	SDAT	serial data in- and output	
11	INTN	Digital I/O for interrupt from comparator conversion ready flag for external interrupt and synchronisation	signal wake-up to external μ C in normal mode
12	VDDD	+ 5V digital power supply	
13	VDDA	+ 5V analog power supply	
14	REF	reference input/output	must be connected to VSS with a 30 nF capacitor
15	AGND	analog ground, ground reference for ADC	this PIN must be connected with a 50-100nF-capacitor to VSS; no direct connection to VSSD/VSS allowed
16	ETR	analog input with reference to RSHL analog output for current-source	

Table 1: Pin Description

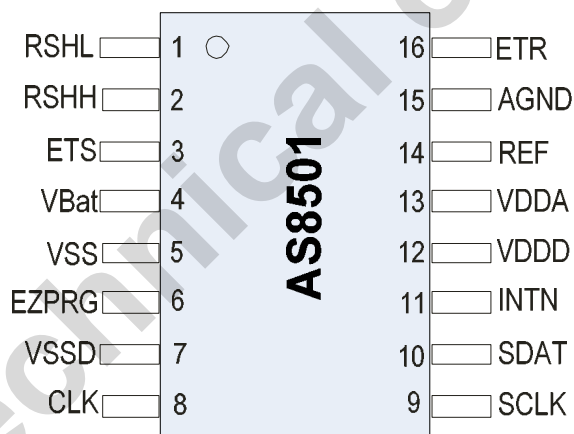

Figure 2: Schematic Package outline SOIC 16

5 Absolute Maximum Ratings

Stress beyond those listed under "Absolute Maximum Ratings" may cause permanent damage to the device. These are stress ratings only. Functional operation of the device at these or any other conditions beyond those indicated under "Operating Conditions" is not implied. Exposure to absolute maximum rating conditions for extended periods may affect device reliability. All voltages are defined with respect to VSS and VSSD. Positive currents flow into the IC.

Absolute maximum ratings ($T_A = -40^\circ\text{C}$ to 125°C unless otherwise specified)

Nr.	PARAMETER	SYMBOL	MIN	TYP	MAX	UNIT	NOTE
0	Supply voltage Analogue VDDA and digital VDDD	VDD	-0.3		7.0	V	Polarity inversion externally protected
1	Input pin voltage	V_{in}	-0.3		VDD +0.3	V	
2	Input current (latch-up immunity)	I_{SCR}	-100		100	mA	JEDEC 17
3	Electrostatic discharge	ESD	-2		2	kV	¹⁾
4	Ambient temperature	T_A	-40		125	$^\circ\text{C}$	($T_j = 150^\circ\text{C}$)
5	Storage temperature	T_{STRG}	-55		150	$^\circ\text{C}$	
6	Soldering conditions	T_{LEAD}			260	$^\circ\text{C}$	²⁾
7	Humidity, non-condensing		5		85	%	
8	Thermal resistance	R_{thJA}			75	K/W	
9	Power dissipation	P_{TOT}			350	mW	

Notes:

¹⁾ MIL 883 E method 3015, HBM: R = 1.5 k Ω , C = 100pF.

²⁾ Jedec Std – 020C, lead free

6 Electrical characteristics

VDDA=5V +/-0.1 V, fclk=8.192 MHz, chopping ratio MM=4 (see 7.5.3), oversampling frequency=2.048 MHz, oversampling ratio=128
 temperature range : -40 to 125°C if not otherwise noted

symbol	parameter	conditions	min	typ	max	units		
input characteristics								
G1	for gain 1 the input signal is connected directly to the input of the converter, this is not possible for the RSHH-RSHL input							
Gain	gains of PGA	6, 24, 50, 100						1)
AC_g6	Accuracy at gain 6	0 to 85 °C	1.0			% @ -120mV	2)	
		-40 to 125°C	1.5			% @ -120mV	3),4)	
AC_g24	Accuracy at gain 24	0 to 85 °C	0.5	0.08		% @ +20mV	2)	
		-40 to 125°C	1.5	0.3		% @ +20mV	3) 4)	
AC_g50	Accuracy at gain 50	0 to 85 °C	1.0			% @ +/-10mV	4)	
AC_g100	Accuracy at gain 100	0 to 85 °C	1.0			% @ +/-5mV	4)	
Vin	input voltage ranges (with reference to RSHL)	G1	-350	-300 to + 800	900	mV	5) 6)	
		G6	-200	+/- 120	160	mV	5) 7)	
		G24	-40	+/- 30	40	mV	5) 7)	
		G50	-20	+/- 15	20	mV	5) 8)	
		G100	-10	+/- 7.5	10	mV	5) 8)	

Notes:

- 1) the absolute gain values are subjected to a manufacturing spread of +/-30% max in the full temperature range. all gain values can be digitally calibrated together with the external circuitry with a resolution better than 0.065%
- 2) Current measurement paths for G6 and G24 are trimmed for minimum Temperature coefficient. The trim algorithm is based on a 2 temperature measurement at 23°C and 60°C.
Accuracy is mainly determined by bandgap characteristic and gain variation over temperature.
A TC shift of typically -15 ppm/K will occur during solder process which is compensated by a systematic offset during trimming.
- 3) due to a nonlinear behaviour of the gain and reference voltage over temperature the accuracy is lower for the extended temperature range.
- 4) The minimum limits for G50, G100 are derived from device characterization and not tested. Towards 125°C the TC values are higher. therefore it is recommended to use these gain settings only for applications in the temperature range 0 to 85°C.
- 5) if not otherwise specified the ranges are calibrated to the typical values. The maximum and minimum value represent the maximum usable span accepting linearity deviation up to 1000 digits. Min, max limits are tested at room temperature only!
- 6) this gain range is not using the internal PGA, the input is directly connected to the AD-converter. Therefore the input resistance is lower than for other gain ranges.
It has been designed mainly for positive input voltages up to 0.8 V i.e. for measurements of temperature with transistors and diodes.
The limitation for negative input voltages is due to the onset of conduction of the input protection diodes.
- 7) the ASSP is optimised for G6 and G24 concerning linearity, speed and TC, therefore these ranges are recommended whenever possible.
- 8) because of higher TC value at elevated temperature G50 and G100 are recommended for applications in the temperature range 0 to 85°C

Electrical characteristics (continued)

VDDA=5V +/-0.1 V, fclk=8.192 MHz, chopping ratio MM=4 (see 7.5.3), oversampling frequency=2.048 MHz, oversampling ratio=128
 temperature range : -40 to 125°C if not otherwise noted

symbol	parameter	conditions	min	typ	max	units
cal_err	calibration error for 30 000 digits output at full range	G1, 720 mV G6, 120 mV G24, 30 mV G50, 15 mV G100, 7.5 mV		0.1	0.2	% ¹⁾
lin_err	nonlinearity	gain 6 @ room temp gain 24 @ room temp gain 50 @ room temp gain 100 @ room temp		0.1 0.03 0.05 0.05	0.3 0.05 0.07 0.1	% or 30 digits ²⁾ % or 10 digits ²⁾ % or 15 digits ²⁾ % or 20 digits ²⁾
lin_errTC	TC of linearity error	all gains		1	5	ppm/K ³⁾
Vos	offset voltage: RSHH_RSHL offset voltage: ETS, ETR, VBAT	-40 to 125°C -40 to 85°C 85 to 125°C	-0.5 -2 -4	0.2 0.5 1	0.5 1 2	μV ⁴⁾ μV ⁴⁾ μV ⁴⁾
dVos/dT	Offset voltage drift: RSHH- RSHL	-40 to 85 °C		0.002		μV/K
Ib	input bias/leakage current, all channels	room temperature	-1	0.2	1	nA ⁵⁾
Vndin	voltage noise density (G=24)	f=0 to 1 kHz		35	50	nV//Hz ⁶⁾
Indin	current noise density (G=24)	f=10 Hz	5	20	100	fA//Hz ⁶⁾
en_p_p	voltage noise, peak (G=24)	0 to 100 Hz 0 to 10 Hz	2 0.5	3 1	5 1.5	μV ⁶⁾ μV ⁶⁾
en_RMS	voltage noise, RMS (G=24)	1000 Hz		1.5	2	μV
SNR	signal to noise (G=24, G4.8)	room temperature	90	100		dBmin
SDR	signal to distortion (G24, G4.8)	room temperature	80	100		dBmin
CCI	channel to channel insulation	room temperature	-70	-90		dBmax
PSRR	power supply rejection ratio	4.9 to 5.1 V	-50	-60		dBmax

Notes:

- 1) at room temperature / corresponding calibration factors are stored within the ZZR-register
- 2) whatever is lower. Maximum limits for gains 50 and 100 are derived from device characterization and are not tested.
- 3) this value measured in raw mode at room temperature and at 60°C. Maximum limits over temperature range are derived from device characterization.
- 4) TC variations are included in the above given maximum limit of linearity error. Max value is derived from device characterization and not tested
- 5) Leakage current is specified for all gain settings (except G1) for positive input voltages below 200 mV. Test is done at different input voltages with subsequent extrapolation for 200mV. In the temperature range 85-125°C it may be as high as 5 nA at the upper limit. In normal operation a temperature independent digital offset of -0.7 digits is present due to internal rounding.
- 6) This parameter is not measured directly. It is measured indirectly via gain measurement of the whole path at room temperature

Electrical characteristics (continued)

VDDA=5V +/-0.1 V, fclk=8.192 MHz, chopping ratio MM=4 (see 7.5.3), oversampling frequency=2.048 MHz, oversampling ratio=128 temperature range : -40 to 125°C if not otherwise noted							
symbol	parameter	conditions	min	typ	max	units	
data conversion							
RES	resolution	all channels		16		bits	1)2)
Vref	reference voltage	room temperature	1.13	1.21	1.30	V	3)
Vref_TC	temperature coefficient of Vref		-50		50	ppm/K	4)
Vref_Ri	internal resistance of Vref	Rload > 50 kOhm		200		Ohm	
fovs	clock frequency			4.096		MHz	
R1	oversampling ratio		64	128			
MM	conversions during chopper cycle			4	8		
BW	bandwidth		7.8	1000	16000	Hz	
av	internal averaging		1	4	1024	cycles	
fclk	external clock frequency		0.05	8.192	10	MHz	5)
CLK_extdiv	clock division factor			2	4		
DR_clk	duty ratio of external clock			50		%	
int_fclk	internal clock frequency		180	250	330	kHz	
analog inputs		RSHH, VBAT, ETS, ETS					
Rin	input resistance	Ue < 150 mV	50	100		MOhm	
Cin	input capacitance at gain 24		8	15	30	pF	
internal temperature sensor							
T_out20	output at 23°C	G 6, typical	22500	23 000	23500	digits	6)
T_sl	slope	-20 to 100°C	73	75	77	digits/degC	7)
Terr85	error of temperature measurement	0 to 85°C		0.5	2	degC	7)
Terr125		-40 to 125°C		1	3	degC	7)
current source		output to RSHH, RSHL					
Icurr_rshh			1.5	2	3	µA	

Notes:

- 1) with external averaging the resolution can be increased up to 21 bits with an effective sampling rate below 10 Hz
- 2) the system works in overflow condition without degradation of accuracy up to 1.4 * range width.
This means that the overflow bit can work as bit no.17 in this range.
- 3) the absolute value will be trimmed digitally to (1.28±0.01) V at 23°C, if not otherwise specified
- 4) the TC-value will be trimmed digitally to end up with a typical TC-value of the output (total measurement path) at G24 better than 20 ppm/K the TC- value of the
reference voltage after trimming may be typically as high as 50 ppm/K due to manufacturing spread. Min,max limits are not tested but derived from device characterization
- 5) in the temperature range 0 - 85°C the clock frequency can be increased to 12 MHz
- 6) value trimmed to +/- 30 digits during final test and stored into ZZR
- 7)The slope of the sensor is measured on sample basis per lot and not tested per device. The specified limits are derived from device characterization.

Electrical characteristics (continued)

VDDA=5V +/-0.1 V, fclk=8.192 MHz, chopping ratio MM=4 (see 7.5.3), oversampling frequency=2.048 MHz, oversampling ratio=128 temperature range : -40 to 125°C if not otherwise noted							
symbol	parameter	conditions	min	typ	max	units	
programmable current source		output to Vbat, ETS, or ETR					
Icurr_ON	current level		0		248	μA	
I_steps	current steps		6	8	10	μA	
Dcurr	accuracy, room temperature	248 μA		0.2	0.5	%	
TC_CS	temperature coefficient		830	900	1000	ppm/K	1)
Icurr_OFF	current when off	room temperature		0.001	0.01	μA	
Icurr_Ri	internal resistance of current source	Ua < 2 V		10		MOhm	
digital CMOS inputs with pull up and schmidt-trigger		input PINs CLK and SCLK					
Vih	high level input voltage	VDDD=5V	3.5			V	
Vil	low level input voltage	VDDD=5V			1.5	V	
Iih	current level	VDDD=5V, Vih=5V	-1		1	μA	
Iil	current level	VDDD=5V, Vil=0	30		120	μA	
digital CMOS outputs		output PINs SDAT and INTN					
Voh	high level output voltage	VDDD=5V, -633uA	4.5			V	
Vol	low level output voltage	VDDD=5V, 564uA			0.4	V	
Cl	capacitive load				20	pF	
Tristate digital I/O							
Voh	high level output voltage	VDDD=5V, -633uA	4.5			V	
Vol	low level output voltage	VDDD=5V, 564uA			0.4	V	
Ioz	tristate leakage current to VDDD,VSSD	VDDD=5V	-1		1	μA	
Vih	high level input voltage	VDDD=5V	3.5			V	
Vil	low level input voltage	VDDD=5V			1.5	V	
EZPRG input							
Vprg	programming voltage - for factory programming only	VDDD=5V	-	-	-	V	2)
supply current							
I _{sup}	normal operation	VDDD=VDDA=5V		3	5	mA	
I _w	active wake-up	VDDD=VDDA=5V		40	100	μA	3)
supply voltage							
VDDA	positive analog supply voltage		4.7	5.0	5.3	V	4)
VDDD	positive digital supply voltage		4.5	5.0	5.5	V	
VSS, VSSD	negative supply voltage			0		V	
Power On Reset							
Vporhi	Power on reset Hi		2.5		4.1	V	5)
Vhyst	Hysteresis		0.1		0.3	V	5)

Notes:

- 1) not tested, derived from device characterization
- 2) for factory calibration only. During normal operation this PIN must be connected to VDDD.
- 3) the average current is dependent on the on-time of the measurement system i.e. it can be programmed via the CRA register
- 4) stability of analog supply should be within +/- 0.1 V
- 5) tested at room temperature only

7 Functional Description

7.1 Power on Reset

The power on reset is initiated during each power up of the ASSP and can be triggered purposely by reducing the analog supply voltage (VDDA) to a value lower than V_{porlo} for a time interval longer than 0.5 μ sec.

During power on reset sequence the following steps are performed automatically:

- The chip goes to mode MZL (see 7.4)
- Internal clock is enabled
- The calibration constants are loaded from Zener-zap memory to the appropriate registers (ZTR=>TRR, ZCL=>CAR). The load procedure is directed by the internal clock and can be monitored on INTN pin. 188 clock pulses are generated from the internal oscillator source. Pulse period is equal to internal clock period.

After the power-on reset sequence is finished:

- the operation continues with internal clock if no external clock is detected. In this case the ASSPs switches to mode MWU with default value of threshold register (2^{14})
- If external clock is available the ASSP switches to mode current measurement MMS (default measurement with default configuration: gain=100, f_{ovs}=4.096MHz, R1=64, MM=4, R2=1, N_{TH}= 2^{14}).
- The microcontroller can communicate via SDI interface whenever appropriate, i.e. CAR and TRR register can be rewritten from the μ C if necessary.
- Because the automatic selected calibration factor (CGI4) is loaded with zeros, the ASSP delivers constant zero at the output to allow the μ C to check for an unwanted POR. To bring the ASSP back into normal operation for current measurement with gain100 the μ C has to copy the CAU4 content into the CGI4 factor in the CAR-register. (see also 7.5.5 and 8.6.2)

7.2 Analog part, general description

The input signals are level shifted to AGND (+ 2.5 V) then switched by the special high quality MUX- which contains also the chopper – to the input of the programmable gain amplifier (PGA). This low noise amplifier is optimised for best linearity, TC- value and speed at gain 24.

The systems contains an internal bandgap reference with high stability, low noise and low TC-value. The output of a programmable current source can be switched to the analog inputs VBAT, ETS and ETR for testing the sensor connections or for external activation of resistors, bridges or sensors (RTD, NTC). The voltage drop generated by the current is measured at the corresponding input/output PIN.

For the wire break test of the RSHH and RSHL inputs special low noise current sources are implemented.

The integrated temperature sensor can also be switched to the PGA by the MUX and measured any time. The chip temperature can be used for the temperature compensation of the gain of the different channels in the external μ C, which increases the absolute accuracy considerably.

The offset of the amplifier itself is already fairly low, but to guarantee the full dynamic range it can be trimmed via the digital interface to nearly zero independent of the autozero chopping function.

In the same way the manufacturing spread of the absolute value of the reference voltage can be eliminated and the TC-value set to nearly zero by a trimming process via the SDI interface.

For more details of the input multiplexer see the following schematic. The position of all switches is defined by writing into the registers CRA, CRB and CRG via the SDI bus, which is explained in 7.5.2 through 7.5.4.

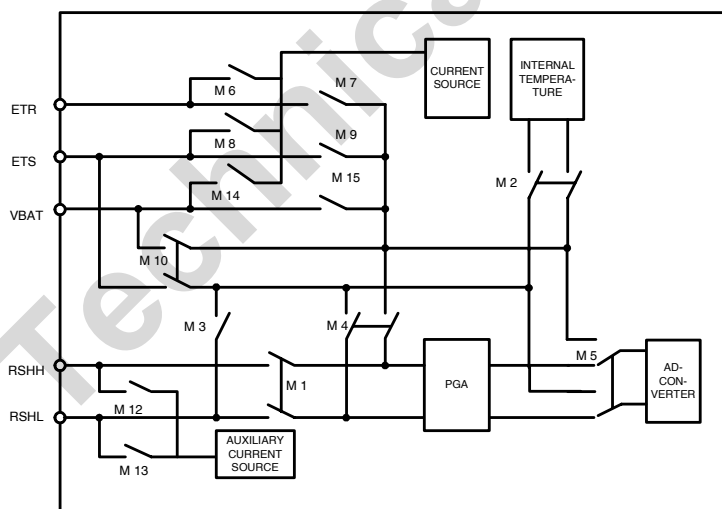

Figure 3: Multiplexer

7.2.1 Reference voltage

The ASSP contains a highly sophisticated precision reference voltage. Its typical temperature dependence is a slight parabola shaped curve and is shown in figure 21. This reference voltage is used mainly for the internal AD-converter, but can also be used for external purposes if the impedance of the external circuitry is high enough.

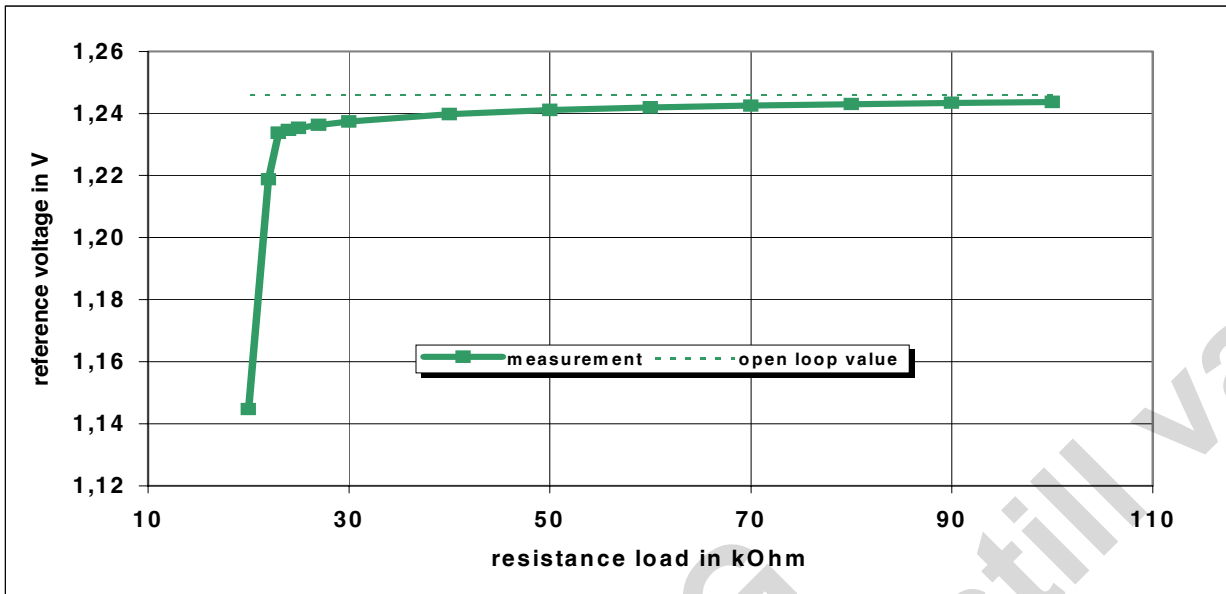

Figure 4: Reference voltage as function of resistance load

The absolute value and its temperature coefficient (TC) is given by the content of the TRR register. This opens the possibility to calibrate the reference voltage to the optimum absolute value (i.e. 1.28 V) and the TC value to zero thus eliminating fully the production spread.

Writing into subregister TRIMBV of TRR changes the absolute value linearly by 5.1 mV per digit as shown in the following graph and described in full detail in 7.5.7

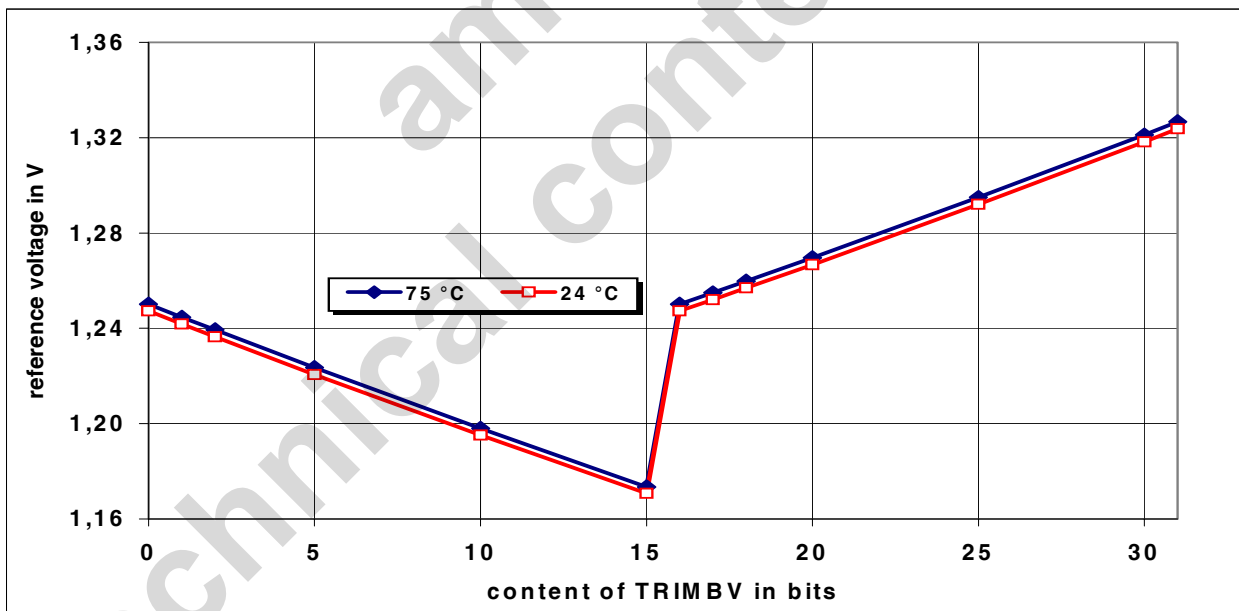

Figure 5: Reference voltage as function of temperature

Trimming the TC value is similarly done by writing into subregister TRIMBTC. Since the TC trimming is also changing the absolute value it is important to trim the TC first and then the absolute value.

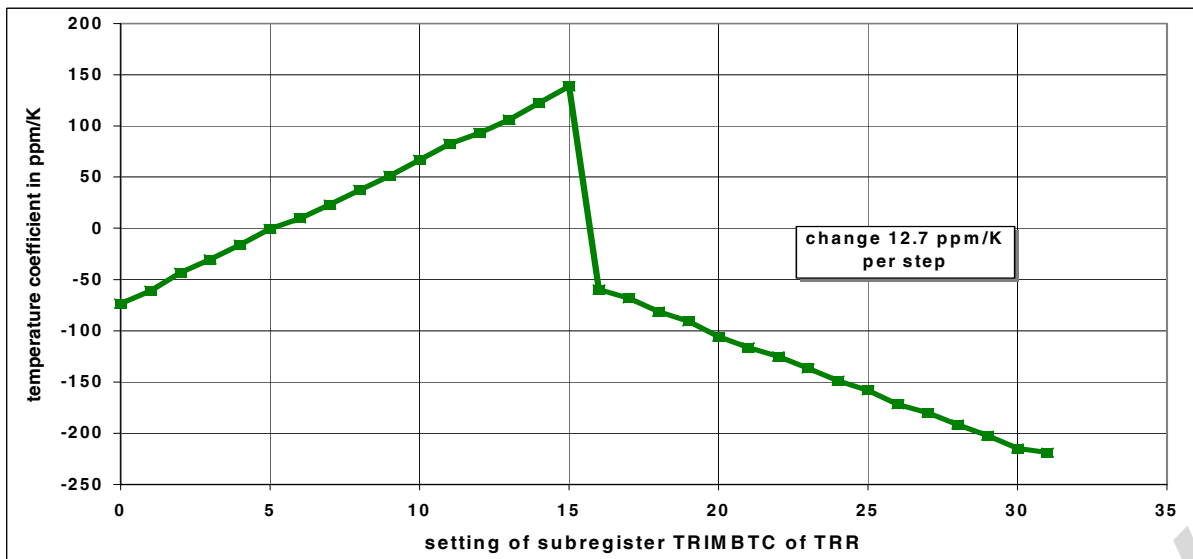

Figure 6: Temperature coefficient as function of TRIMBTC setting

The TC trimming also opens the unique possibility to change the TC-value within the time of reprogramming of the TRR-register (i.e. within μsec) to allow the compensation of different TC-values of the external circuitry for different channels.

In addition it can be used for very fast autocalibration of the total TC of a given channel. An external reference voltage is applied to the channel to be checked. Then all numbers from 0 to 31 are written into subregister TRIMBTC and a reading is done for the input voltage and the internal temperature as well. The same is repeated at any temperature above RT. From these data the TRIMBTC setting for a minimum drift can be easily calculated.

7.2.2 Current sources

The AS8501 contains several current sources which can be used for checking all input lines for wire brake, to control external circuitry or to activate external sensors.

Main current source

The main current source can be digitally controlled via the content of the CRG register in 31 steps of $8\ \mu\text{A}$ in the range of 0 to $248\ \mu\text{A}$. Its absolute value can be calibrated by writing in the subregister TRIMC of TRR.

The current source can be switched to the inputs VBAT, ETR or ETS to activate external sensors like RTDs, NTCs or resistance bridges and strain gages. It can also be used to detect a wire break of external connected sensors. Performing a measurement with a high and a low (or zero) current opens the possibility to eliminate thermal EMF voltages in external sensors.

Secondary current sources

The ASSP contains two other high quality current sources supplying a current of approx. $2\ \mu\text{A}$ at the inputs RSHL and RSHH. These current sources can be switched on and off at any time to check the correct connection of both terminals. During off state they must not interfere with the high sensitive voltage inputs, especially the noise level should not be increased. If one of the terminals is an open connection the amplifier goes into saturation and the overflow bit is set.

7.2.3 Internal temperature sensor

The ASSP contains a high sensitive precision temperature sensor which can be used at any time. The sensor supplies a very linear voltage signal with an offset at 23 degC, which is calibrated and stored in the ZZR-register. The voltage can be measured using the internal circuitry with gain 6, with free selection of all other parameters defining the sampling rate.

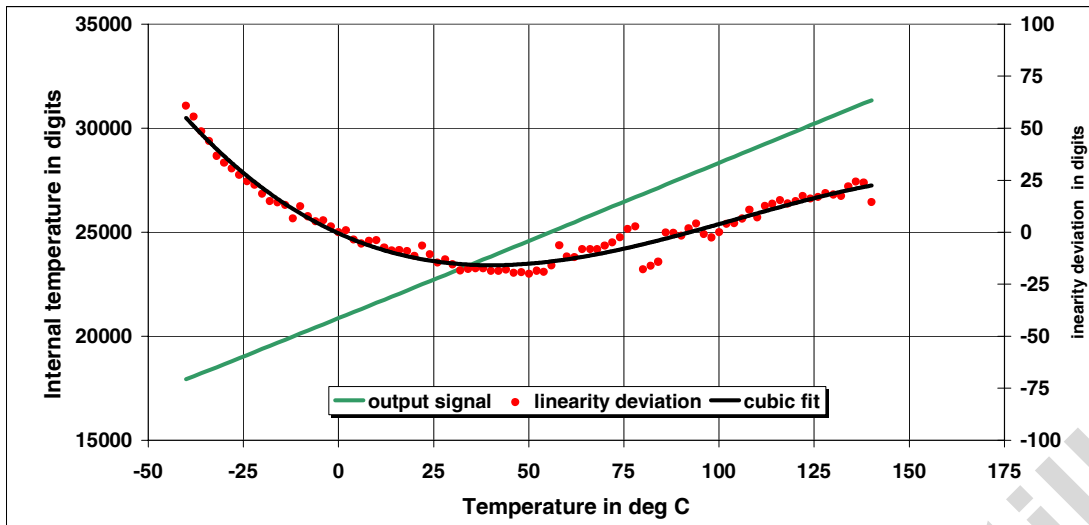

Figure 7: Measurement of internal temperature sensor over oil bath temperature

The slope of the curve is approx. 75 digits per degC.

The calculation of the temperature has to be done in the external μ C acc. to the following simple formula:

$$T_{int} = (U_{int}(T) - U_{int}(23)) / 75 + 23^{\circ}\text{C}$$

$U_{int}(T)$ is the measured result and $U_{int}(23)$ is the reference value at 23°C, which is stored as an 11 bit-word in the ZZR-register.

Bits 15, 14, 13 and 12 will always be the same at room temperature (0101 bin or 20480 dec), therefore it makes no sense to store them for each single part. In addition we don't need the high resolution of one digit, which means $1/71.3 = 14$ milli Kelvin. Therefore we cut the last bit and achieve a word of 11 bit length, which finally is stored in the ZZR-register as shown in the 'stored ZZR-register mapping' given in 8.6.2

Example:

value stored in the ZZR-register:

1060 dez or 10000100100 bin

$$U_{int}(23) = \begin{array}{l} 0101 \quad 10000100100 \quad 0 \\ \text{Add} \quad \text{register content} \quad \text{Add} \end{array} = 22600 \text{ dec}$$

If your measured value is : $U_{int}(T) = 23767$ dec

$$T_i[^{\circ}\text{C}] = ((23767 - 22600) / (75 \text{ digits} / ^{\circ}\text{C})) + 23^{\circ}\text{C} \\ = 15.6^{\circ}\text{C} + 23^{\circ}\text{C} = 38.6^{\circ}\text{C}$$

7.3 Digital part

In the digital part the result of the AD-converter is processed, i.e. calibration, active offset cancellation and filtering is done. In addition the communication via the serial SDI interface is handled and all circuit functions (like voltage and current path settings, chopping, dechopping) are controlled.

Whenever the power supply line returns from below 2.0 V to above 3.5 V a power-up circuitry is activated which loads the internal calibration registers from the Zener-Zap memory into the working register and starts the chip in a special default mode.

7.3.1 Sampling rate

the sampling rate (SR) is defined by the setting of parameters in register CRA or CRB. The oversampling frequency (OSF), the oversampling ratio (OSR), the chopping ratio (MM) and the averaging number (AV). The sampling rate can be calculated acc. to the following formula:

$$SR = OSF / (OSR * MM * AV)$$

For an clock frequency of 8.192 MHz it can vary between 16 000 kHz and 1.95 Hz.

In the dual mode the ASSP is switching automatically between the two channels and it needs at least one measurement for each polarity to get a valid measurement. In addition the ASSP needs some time to reprogram the internal registers and switches. Therefore the maximum sampling frequency is limited to 7.5 kHz for the above given clock frequency. The internal averaging is not working in the dual mode, but the sampling frequency can be different for each channel.

7.3.2 Calibration

The calibration of the ASSP is done by a test setup as follows:

- room temperature calibration of the internal temperature sensor
- absolute input-output calibration for all gain settings
- TC calibration for the measurement path for gain 24

The absolute input-output calibration of the gain ranges is done that way that for a given input voltage 30 000 digits at the output are produced:

Table 7.2.2

gain	input/mV	output/digits
1	720	30 000
6	120	30 000
24	30	30 000
50	15	30 000
100	7.5	30 000

In addition the ASSP receives an individual 24-bit serial number.

The TC-value of the output (total measurement path) for G24 is trimmed to a minimum value by selecting the best setting of the TRIMBTC subregister of the TRR register (see 7.5.7).

A similar calibration is done for the other subregisters TRIMBV, TRIMA and TRIMC for the absolute value of the reference voltage, the offset of the PGA and the current source respectively.

All these data are stored in the ZZR register according to the 'stored ZZR-register mapping' given in 8.6.2

7.4 Modes of operation

The AS8501 can run in different operation modes, which are selected and activated via the serial interface.

Detailed description:

Mode 0: MZL

In power-on reset sequence, which is initiated by the on-chip power-on reset circuit whenever the power is connected, the registers are loaded from the Zener-Zap memory.

Mode 1: MMS

Measurement mode where the definition is taken from the registers CRA and CRG defined later on. The measurements are continuous and measured results are available after the ready flag (INTN pin) is set to LO. The result can be read by the μ C any time after this bit is set to LO. However, to obtain the best noise performances the result should be read when INTN pin is at LO state. All modules are in power-up.

Mode 2: MMD

Dual channel measurement mode. Two consecutive different measurements are performed according to the settings in the configuration registers CRA, CRB and CRG defined later (usually CRA defining current measurements and CRB voltage measurement). One complete measurement is performed with each setting. CRG register holds common settings.

The measurements are continuous (A,B,A,B). The 17th bit in the output register defines, which measurement has been executed according to the definition LO=A, HI=B.

The number of consecutive measurements with equal configuration is defined in register CRG (bits s3,s2,s1,s0). All modules are in power-up.

Mode 3: MWU

In this wake-up mode the internal clock finclk=256kHz is running and one complete measurement is performed in the period from 1 to 1.5 s with the parameter settings of the CRA register. Before the actual measurement is performed the logic powers up all internal circuits especially the AGND and the Vref. If the external load is higher than 70 kOhms both signals can be used for external triggering or even as interrupt for the μ C.

If the external clock is not running, this input should be high impedance. To achieve a stable low idle current the oversampling ratio should be set to R1=128 and the CFG register must be programmed to x00003, see also 7.5 'Register description'. It is assumed that the threshold level in the THR register is defined within the 16 bit range, if not the default value is 210

After one measurement is finished all modules except the on-board oscillator and divider are switched into power down condition to save power. The MSR register is updated with the last measurement result. Whenever this value exceeds the digital threshold the (wake-up) INTN pin goes LO for one clock cycle to trigger the wake-up event in the external μ C.

After that the circuit returns in power-down for approximately 1s. During this time the last measurement (MSR register) is available on the SDI interface.

In this intermediate sleep-mode all modules except internal oscillator and divider are in power-down mode. The SDI interface works independent which means that the measurement result is available by reading the MSR register. At any time the microprocessor can start any other mode via SDI. In such a case the external clock must be switched on first.

The chip goes in MWU mode (mode 3) after it received the command for that. After that command 6 or more additional CLK pulses are needed before external clock may go to power down mode (no CLK pulses, high level because of internal pull-up resistors). This 6 CLK pulses are needed for synchronisation. On the way back to normal mode this restriction is not needed.

Mode 4: MAM

In this alarm mode the measurement defined in CRA is going on. The channel bit in the THR register must be cleared (channel A). The threshold value may be positive or negative. Whenever the measured value exceeds the digital threshold value in the THR register the pin INTN (in this mode its function is to signal alarm-condition) goes LO for one clock cycle. For negative threshold value the signed measurement result must be more negative than the THR value to activate the alarm. During measurements the signal INTN is high. All modules are in power-up, measurements are continuously going on.

Mode 5: MZP

Zener-Zap programming/reading. This mode for factory programming only and should not be used by the customer.

Mode 6: MPD

Power down mode. Individual analog blocks can be disabled/enabled. The data acquisition system is not running during this mode is activated.

Mode 7: MSI

The operation in this mode is exactly the same as in MMS mode except that the internal clock is used.

The SDI interface signals can become active whenever appropriate. This mode can be used if no external clock CLK is available. The measuring speed is reduced by a factor of 16.

Modes 8-15: These modes are reserved for testing purposes and should not be used by the customer. Reading and writing of some registers is only possible in these higher modes. Write to registers CAR (calibration register) and TRR (trimming register) is allowed only in test modes.

Modes of operation, register OPM

Mode	Name	Description	mo3	mo2	mo1	mo0
0	MZL	Power on, loading from Zener-Zap memory	0	0	0	0
1	MMS	Single measurement	0	0	0	1
2	MMD	Double measurement (A,B,A,B ...)	0	0	1	0
3	MWU	Wake-up	0	0	1	1
4	MAM	Alarm	0	1	0	0
5	MZP	Zener program/read	0	1	0	1
6	MPD	Power down	0	1	1	0
7	MSI		0	1	1	1
8-15		Reserved for testing ¹⁾	1	x	x	x

Notes:

- 1) Register addresses 12, 13, 14 and 15 are reserved for testing and future options; operations on these registers must be avoided

7.5 Register description

In the following sections the register contents and their functions are described in detail. Since the length of some registers is too long to present clearly, the registers are logically subdivided according to their functions and described separately.

All internal functions are controlled by the contents of these registers which can be reloaded via the serial SDI interface at any time. The AS8501 contains the following registers:

REGISTER	ADDRESS	SIZE	Contents	Detailed description see
OPM	0	4	Operating mode register	7.5.1
CRA	1	17	Measurement A configuration register	7.5.3
CRB	2	17	Measurement B configuration register	7.5.4
CRG	3	28	General configuration register	7.5.2
MSR	4	18	Measurement result register	7.5.9
ZZR	5	188	Zener-Zap register	7.5.5
CAR	6	110	Calibration register	7.5.6
TRR	7	20	Trimming register	7.5.7
THR	8	17	Alarm or wake-up threshold register	7.5.8
CFG	9	20	Test and special configuration register	¹⁾
reserved	10-12		Test registers	

Note: ¹⁾ This register is reserved for testing modes. Writing is possible only in mode 8. In order to assure stable conditions in power-down modes MWU(3), MPD(6), TMSS(8) and MSI(13) the default setting of the CFG register must be changed to x00003. It is not necessary to change this value during normal operation.

Write commands not supported in a certain mode can be released immediately after the register address. The ASSP will resume operation with the next start condition. Registers CAR and TRR are not buffered. Any read operation of the CAR or TRR register may generate transients in the analog circuitry; further accurate measurements require a delay time for settling.

7.5.1 OPM operation mode register (4 bits)

no.	Bit	mo3	mo2	mo1	mo0	Note
0	default	0	0	0	0	1)

1) This register has been described in detail under 7.4

7.5.2 CRG general configuration register (28 bits)

no.	CRG bits	27-22	21-11	10-7	6-0	NOTE
0		CRS	CRI	CRV	CRP	

subregister CRS: Sequence length, dechop and chop (6 bits)

Nr.	Bits	5	4	3	2	1	0	NOTE
0	CRS bit names	s3	s2	s1	s0	d	c	1)
1	Default	0	0	0	1	1	1	2)

Notes:

1) This register defines the sequence length, chopping (c) and dechopping (d) of the input signal

2) Default power-up state before any setting

Sequence length bits (4bits)

Nr.	No. of measurements	s3	s2	s1	s0	NOTE
0	16	0	0	0	0	1)
1	1	0	0	0	1	default
...	
14	14	1	1	1	0	
15	15	1	1	1	1	

Notes:

1) Number of consecutive measurements of A and B with settings defined in CRA, CRB and other settings in CRG register. This setting is used only for mode MMD.

DECHOPPING BIT

Nr.	Dechopping	d	NOTE
0	No dechopping	0	
1	Dechopping	1	

CHOPPING BIT

Nr.	Chopping	c	NOTE
0	No chopping	0	
1	chopping	1	

subregister CRI: Current configuration (11 bits)

Nr.	Bits	10	9	8	7	6	5	4	3	2	1	0	NOTE
0	CRI bit names	M14	M13	M12	M11	M8	M6	i4	i3	i2	i1	i0	1),3)
1	Default	0	0	0	0	0	0	0	0	0	0	0	2)
2	output	VBAT	RSHL	RSHH	no	ETS	ETR						

Notes:

1) whenever M1=1 in (CRA,CRB) it is good practice to set all M6 to M14 to zero, but it is not mandatory

2) default logic state after power up and before any setting

3) All bits with names M14 to M1 represent control signals of the multiplexer with positive logic (for example M14=1 means that corresponding switch is closed).

Current source setting bits (5 bits)

Nr.	Current [uA]	i4	i3	i2	i1	i0	NOTE
0	0	0	0	0	0	0	
1	8	0	0	0	0	1	
2	16	0	0	0	1	0	
3	24	0	0	0	1	1	
4	32	0	0	1	0	0	
...	
31	248	1	1	1	1	1	

subregister CRV: Voltage configuration (4 bits)

Nr.	Bits	3	2	1	0	NOTE
0	CRV bit names	M15	M10	M9	M7	^{1),3)}
1	Defaults	0	0	0	0	²⁾
2	channel	VBAT-RSHL	VBAT-ETS differential	ETS-RSHL	ETR-RSHL	

Notes:

- ¹⁾ This register defines the connection of the analog voltage-bus to the input-PINs and to the A/D converter
²⁾ Default logic state after power-up and before any setting

subregister CRP: Power down configuration (7 bits)

Nr.	Bits	p6	p5	p4	p3	p2	p1	p0	NOTE
0	CRP bit names	pdosc	pda	pdm	pdb	pcd	pdi	pdg	^{1),3)}
1	Defaults	0	0	0	0	1	0	0	²⁾
2	block	oscillator	amplifier	modulator	ref. bias	current source	internal temp.	analog GND	

Notes:

- ¹⁾ This register defines the power-down signals of the building blocks
²⁾ Default power-up state before any setting
³⁾ The logic is positive (pdosc=1 means the corresponding block is in power-down)

7.5.3 CRA measurement channel A configuration register (17 bits)

Nr.	Bits	16	15	14	13	12	11	10	9	8	7	6	5	4	3	2	1	0	NOTE
0	CRA bit names	cu2	cu1	cu0	M5	M4	M3	M2	M1	g1	g0	f	r	mm	n3	n2	n1	n0	^{1),3)}
1	Defaults	0	0	0	0	0	0	0	1	1	1	1	0	0	0	0	0	0	²⁾
2	subreg.	CRU			CRM				GN		OSF	OSR	MM	CRN					

Notes:

- ¹⁾ This register defines the measurement channel A configuration
²⁾ Default power-up state before any setting
³⁾ Bit M1 is control signal of the multiplexer for current input (for example M1=1 means that corresponding switch is closed).

subregister CRU: calibration constant selection for voltage path (3 bits) in registers CRA,CRB

Nr.	Calibration const. U	cu2	cu1	cu0	NOTE
0	CAU0	0	0	0	
1	CAU1	0	0	1	
2	CAU2	0	1	0	
3	CAU3	0	1	1	
4	CAU4	1	0	0	
5	CAU5	1	0	1	
6	1548	1	1	0	
7	1548	1	1	1	

subregister CRM: measurement path for registers CRA,CRB

Nr.	Bits	13	12	11	10	9	NOTE
	CRA bit names	M5	M4	M3	M2	M1	^{1), 2)}
1	Defaults	0	0	0	0	1	measurement RSHH-RSHL
2		0	1	0	0	0	voltage bus
3		0	1	0	1	0	voltage bus, internal temperature
4		0	1	1	0	0	voltage bus, reference low=RSHL
5		1	0	0	0	0	voltage bus, gain=1
6		1	0	0	1	0	voltage bus, gain=1, internal temperature
7		1	0	1	0	0	voltage bus, gain=1, reference low=RSHL

Notes:

1) these bits define the inner part of the voltage path settings

2) only the listed combinations are allowed

subregister GN: gain definition bits, Registers CRA,CRB

Nr.	GAIN	g1	g0	NOTE
0	6	0	0	
1	24	0	1	
2	50	1	0	
3	100	1	1	

subregister OSF: oversampling frequency bit, Registers CRA,CRB

Nr.	Fovs (fclk=8MHz)	Fovs (internal osc)	f	NOTE
0	2.048MHz	132kHz	0	¹⁾
1	4.096MHz	264kHz	1	¹⁾

Notes:

¹⁾ For internal oscillator typical values**subregister OSR: oversampling ratio bit, Registers CRA, CRB**

Nr.	R1	r	NOTE
0	64	0	
1	128	1	

subregister MM: chopping ratio bit, Registers CRA, CRB

Nr.	MM	mm	NOTE
0	4	0	
1	8	1	
2	1	x	¹⁾

Notes:

1) For c=0 and d=0, chopping and dechopping is switched off and every cycle is active regardless of mm, i.e. the sampling frequency is higher by a factor of 4

subregister CRN: averaging bits (4 bits), registers CRA,CRB

Nr.	R2	n3	n2	n1	n0	NOTE
0	1	0	0	0	0	
1	2	0	0	0	1	
2	4	0	0	1	0	
3	8	0	0	1	1	
4	16	0	1	0	0	
5	32	0	1	0	1	
6	64	0	1	1	0	
7	128	0	1	1	1	
8	256	1	0	0	0	
9	512	1	0	0	1	
10	1024	1	0	1	0	
11-14	Reserved for test	1	x	x	x	¹⁾
15	raw mode	1	1	1	1	²⁾

Note:

¹⁾ combinations from B to E are reserved for test

²⁾ this mode delivers the AD-values without calibration and averaging but multiplied by a factor which is dependent on the setting of the oversampling ratio. It can be used for high resolution measurements of very low signals since it eliminates the internal rounding error.

The ratio between raw result (Nr) and normal result (Nn) is given by: $Nr/Nn = 2^{(11+x)/CAL}$ where x=6 for R=128 and x=3 for R=64. CAL is the calibration constant used.

7.5.4 CRB measurement channel B configuration register (17 bits)

Nr.	Bits	16	15	14	13	12	11	10	9	8	7	6	5	4	3	2	1	0	NOTE
0	CRB bit names	cu2	cu1	cu0	M5	M4	M3	M2	M1	g1	g0	f	r	mm	n3	n2	n1	n0	^{1), 3)}
1	Defaults	0	0	0	0	1	1	0	0	0	1	1	0	0	0	0	0	0	²⁾
2	subreg.	CRU			CRM					GN		OSF	OSR	MM	CRN				

Notes:

¹⁾ This register defines the measurement channel B configuration, the functions of the subregisters are the same as described above for measurement channel A

²⁾ Default power-up state before any setting

³⁾ In this mode the chip cannot measure the current sensing input RSHH-RSHL, therefore M1=0 for all settings

7.5.5 ZZR Zener-Zap register (188 bits)

Nr.	ZZR bits	183-187	163-182	53-162	0-52	NOTE
0		ZLO	ZTR	ZCL	ZTC ¹⁾	²⁾

Notes:

- ¹⁾ 5 bits are reserved for:
- 1 bit eventually destroyed during testing,
 - 2 bits for testing programmed 0 and 1
 - 2 bits reserved for locking

²⁾ due to a limited driving capability of the ZZR-cells the maximum reading speed is limited to 500 kHz

subregister ZLO: Zener spare bits (5 bits)

Nr.	Name	SYMBOL	WORD WIDTH	Default Hex
1	Reserved bits	ZLO	5	F

subregister ZTR: trimming bits (20 bits)

Nr.	PARAMETER	SYMBOL	WORD WIDTH	Default Dec ¹⁾	UNIT	NOTE
0	TC of reference	TRIMBTC	5	0	Bits	
1	absolute value of reference	TRIMBV	5	0	Bits	
2	amplifier offset	TRIMA	5	0	Bits	
3	current source for external temperature	TRIMC	5	0	Bits	
4	∑ trim bits	TRIMREG	20		Bits	

Notes:

- ¹⁾ Default values must be written before start of the test

subregister ZCL: calibration bits (110 bits)

Nr.	PARAMETER	SYMBOL	WORD WIDTH	Default Dec ³⁾	UNIT	NOTE
0	Calibration G=6, I	CGI1	11	1548	Bits	1),4)
1	Calibration G=24, I	CGI2	11	1548	Bits	1),4)
2	Calibration G=50, I	CGI3	11	1548	Bits	1),4)
3	Calibration G=100, I	CGI4	11	1548	Bits	1),4)
4	Calibration U0	CAU0	11	1548	Bits	1),4)
5	Calibration U1	CAU1	11	1548	Bits	1),4)
6	Calibration U2	CAU2	11	1548	Bits	1),4)
7	Calibration U3	CAU3	11	1548	Bits	1),4)
8	Calibration U4	CAU4	11	1548	Bits	1),4)
9	Calibration U5	CAU5	11	1548	Bits	2),4)
10	∑ cal. Bits	ZCL	110		Bits	

Notes:

- ¹⁾ Decimal default value of the calibration constant for voltage and current is calculated using formula: $CG_{def} = N_{max} \cdot N_{ADdef} = (V_{ref} \cdot 1024) / (V_{in} \cdot G_{max}) = 1548$
- ²⁾ Default calibration constant for absolute value of the voltage proportional to absolute temperature is the same as for any other range because it uses the same amplifier and max voltage at max. temperature is approx. 150mV and the gain selected must be g0.
- ³⁾ Default values must be written before start of the test
- ⁴⁾ Calibration constants are selected dependent on state of M1 (see table below). For M1=1 one of CGI1 to CGI4 is selected according to selected gain of amplifier. For M1=0 the selection of the calibration constants is defined by bits (cu2,cu1,cu0), which are part of CRA and CRB registers and are defined via SDI interface independently of any other selection.

Calibration constant selection truth table

Nr.	cu2	cu1	cu0	M1	g1	g0	CAL CONST	NOTE
0	x	x	x	1	0	0	CGI1	1)
1	x	x	x	1	0	1	CGI2	1)
2	x	x	x	1	1	0	CGI3	1)
3	x	x	x	1	1	1	CGI4	1)
4	0	0	0	0	x	x	CAU0	2)
5	0	0	1	0	x	x	CAU1	2)
6	0	1	0	0	x	x	CAU2	2)
7	0	1	1	0	x	x	CAU3	2)
8	1	0	0	0	x	x	CAU4	2)
9	1	0	1	0	x	x	CAU5	2)
10	1	1	0	0	x	x	1548	
11	1	1	1	0	x	x	1548	

Notes:

1) CGIx calibration constants are selected when M1=1 according to selected gain

2) CGUx calibration constants are selected when M1=0 according to bits cu2 to cu0 defined via SDI in CRA and/or CRB registers.

Subregister ZTC: see register mapping 8.2.6

7.5.6 CAR calibration register (110 bits)

The calibration register holds the calibration constants that are used by the internal DSP for the correction of each measurement. At power-up sequence the Zener-Zap subregister ZCL is copied into the CAR register as shown in fig. 7.4.6.1. The register can be read or written in mode 8 via the SDI bus at any time. In particular it is possible to write preliminary calibration constants with CAR or overwrite the loaded ZCL data, if a calibration has been changed.

Nr.	CAR bits	109-99	98-88	87-77	76-66	65-55	54-44	43-33	32-22	21-11	10-0	NOTE
0	Subregister	CGI1	CGI2	CGI3	CGI4	CAU0	CAU1	CAU2	CAU3	CAU4	CAU5	1), 2)
1	default	1548	1548	1548	1548	1548	1548	1548	1548	1548	1548	

Notes:

- 1) Calibration register is composed of the following constants each having 11 bits:
CGI1, CGI2, CGI3, CGI4, CAU0, CAU1, CAU2, CAU3, CAU4, CAU5
- 2) This register can be read or written at any time via the SDI bus. In particular it is possible to write preliminary calibration constants with CAR or overwrite the loaded ZCL data, if a calibration has been changed.

7.5.7 TRR trimming register (20 bits)

In the TRR register the calibration constants for the reference voltage, for the amplifier-offset trim and for the current source setting are stored. At power-up sequence the Zener-Zap subregister ZTR is loaded into the TRR register. This register can be read or written in mode 8 via the SDI bus. In particular it is possible to write preliminary calibration constants into TRR or overwrite the loaded ZTR data, if a calibration has been changed. The trimming of the TRR-registers is usually done at the factory before supplying the part.

Nr.	TRR bits	19-15	14-10	9-5	4-0	NOTE
0	Subregister	TRIMC	TRIMA	TRIMBV	TRIMBTC	1)
1	default	0	0	0	0	

Notes:

- 1) writing into TRR register is done as usual with the MSB first

subregister TRIMC

change of current source output with TRIMC bits

Nr.	trimcs	trimc3	trimc2	trimc1	trimc0	d/lo %	Notes
0	0	0	0	0	0	0	1), 2)
1	0	0	0	0	1	-1*2.3	1), 2)
2	0	0	0	1	0	-2*2.3	1), 2)
..	
14	0	1	1	1	0	-14*2.3	1), 2)
15	0	1	1	1	1	-15*2.3	1), 2)
16	1	0	0	0	0	16*2.3	1), 2)
17	1	0	0	0	1	15*2.3	
18	1	0	0	1	0	14*2.3	1), 2)
..	
30	1	1	1	1	0	2*2.3	1), 2)
31	1	1	1	1	1	1*2.3	

Notes:

- 1) lo is the current in μA at TRIMC = 00000

2) The output current of the internal current source can be controlled in a wide range via the bit setting in CRG. In some applications it may be necessary to trim the current in the range of +/- 30% for an optimum result of the external temperature measurement. This trimming is achieved with writing into subregister TRIMC of the TRR register. The trimming is done in % for all ranges selected in CRG register.

subregister TRIMA

change of amplifier offset with TRIMA bits

The offset of the PGA should be trimmed to a minimum absolute value to guarantee the full dynamic range with all gain settings.

Nr.	trimas	trima3	trima2	trima1	trima0	V _{offset} mV	Notes
0	0	0	0	0	0	U _{os}	1),2),3)
1	0	0	0	0	1	U _{os} -1*1.34	1),2)
2	0	0	0	1	0	U _{os} -2*1.34	1),2)
..	
14	0	1	1	1	0	U _{os} -14*1.34	1),2)
15	0	1	1	1	1	U _{os} -15*1.34	1),2)
16	1	0	0	0	0	U _{os}	1),2)
17	1	0	0	0	1	U _{os} +1*1.34	
18	1	0	0	1	0	U _{os} +2*1.34	1),2)
..	
30	1	1	1	1	0	U _{os} +14*1.34	1),2)
31	1	1	1	1	1	U _{os} +15*1.34	

Notes:

1) U_{os} is the input offset voltage in mV at TRIMA = 00000

2) Every step of TRIMA settings brings $\Delta\text{offset}=1.34$ mV change in absolute value of the input offset voltage.

If the measured value is U_{os} then the number that should be written into the TRIMA for minimum final absolute value is calculated as $\text{TRIMA}=\text{int}((\text{Uos})/1.34)$ for U_{os} above zero and $\text{TRIMA}=16+\text{int}(-\text{Uos})/1.34)$ for U_{os} below zero.

3) The input offset voltage can be measured with chopping and dechopping bits being cleared in register CRG.

Any input channel as well as gain settings can be used. The input should be shorted to avoid any external voltages to interfere with the measurement. If the measured output voltage is V_a then the offset voltage is calculated acc. $V_{os} = V_a/\text{gain}$.

subregister TRIMBVchange of reference voltage U_o with TRIMBV bits

Nr.	trimbvs	trimbv3	trimbv2	trimbv1	trimbv0	V _{REF} mV	Notes
0	0	0	0	0	0	U _a	1),2)
1	0	0	0	0	1	U _a -1*5.1	1),2)
2	0	0	0	1	0	U _a -2*5.1	1),2)
..	
14	0	1	1	1	0	U _a -14*5.1	1),2)
15	0	1	1	1	1	U _a -15*5.1	1),2)
16	1	0	0	0	0	U _a	1),2)
17	1	0	0	0	1	U _a +1*5.1	
18	1	0	0	1	0	U _a +2*5.1	1),2)
..	
30	1	1	1	1	0	U _a +14*5.1	1),2)
31	1	1	1	1	1	U _a +15*5.1	

Notes:

1) U_a is the reference voltage in mV at TRIMBTC = 00000, the optimum value is 1.232V.

2) Every step of TRIMBV settings brings $\Delta_{BV}=5.1$ mV change in absolute value of the reference voltage.

For trimming the TC value and absolute value of the reference voltage it is recommended to trim the TC value first and then trim the absolute value since TRIMBTC is changing both TC and absolute value, whereas TRIMBV is changing only the absolute value.

If the measured absolute value is U_{am} then the number that should be written into the TRIMBV for optimum final absolute value is calculated as $\text{TRIMBV}=\text{int}((\text{Uam}-1.231)/0.0051)$ for U_{am} above the ideal value and $\text{TRIMBV}=16+\text{int}(-(\text{Uam}-1.232)/0.0051)$ for U_{am} below the ideal value.

subregister TRIMBTCchange of reference voltage U_0 and TC-value with TRIMBTC bits

Nr.	trimbtc5	trimbtc3	trimbtc2 1	trimbtc1 1	trimbtc0	V_{REF} mV	TC ppm/K	Notes
0	0	0	0	0	0	U_0	TC_0	1),2)
1	0	0	0	0	1	$U_0 -1*5.2$	$TC_0 -1*12.7$	1),2)
2	0	0	0	1	0	$U_0 -2*5.2$	$TC_0 -2*12.7$	1),2)
..	
14	0	1	1	1	0	$U_0 -14*5.2$	$TC_0 -14*12.7$	1),2)
15	0	1	1	1	1	$U_0 -15*5.2$	$TC_0 -15*12.7$	1),2)
16	1	0	0	0	0	U_0		1),2)
17	1	0	0	0	1	$U_0 +1*5.2$	$TC_0 +1*12.7$	
18	1	0	0	1	0	$U_0 +2*5.2$	$TC_0 -2*12.7$	1),2)
..	
30	1	1	1	1	0	$U_0 +14*5.2$	$TC_0 -14*12.7$	1),2)
31	1	1	1	1	1	$U_0 +15*5.2$	$TC_0 -15*12.7$	

Notes:

1) U_0 is the reference voltage in mV and TC_0 is the TC value in ppm/K at $TRIMBV = 00000$

2) Every step of TRIMBTC settings brings $\Delta_{BTC}=5.2$ mV change in absolute value of the reference voltage and $S=12.7$ ppm/K change in the slope of temperature dependence. So for trimming the temperature coefficient of the band-gap reference 2 measurements are recommended (at $T_1=25^\circ\text{C}$ and at $T_2=125^\circ\text{C}$). If the measured TC value is TC_m then the number that should be written into the TRIMBTC for minimum final TC is calculated as $trimBTC = \text{int}(TC_m/12.7)$ for positive values and $trimBTC = 16 + \text{int}(-TC_m/12.7)$ for negative values.

The absolute voltage is also changed in this way, which must be compensated by bringing back the absolute value by changing the TRIMBV register. Usually the $TRIMBV_x = -TRIMBTC_x + 1$ is sufficient. If further accuracy or change of absolute value is necessary it can be adjusted by making some more measurements and adjustments.

ZZR REGISTER:

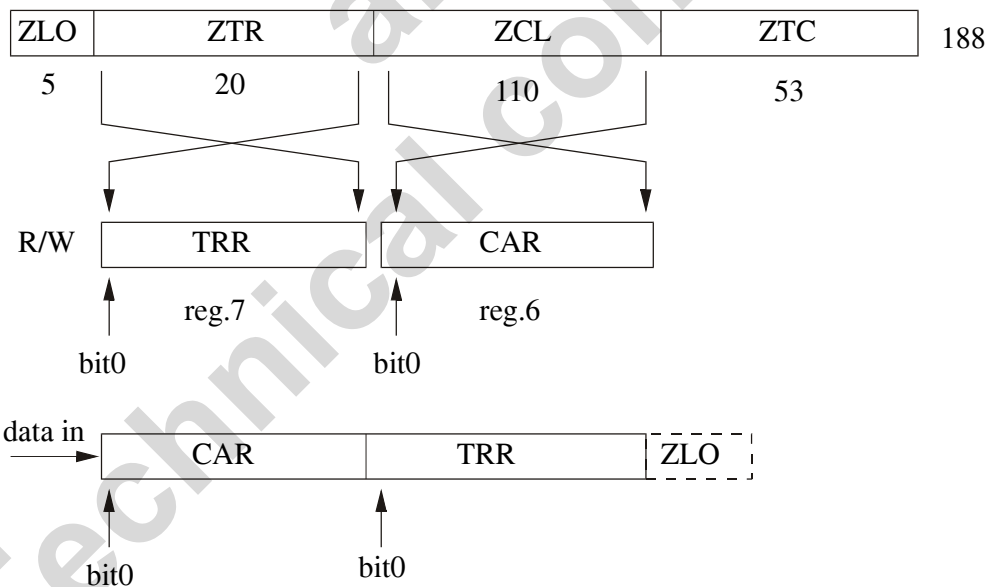

Figure 8: Copying of ZCL and ZTR registers into CAR and TRR registers

7.5.8 THR alarm (Wake-up) threshold register (17 bits)

Nr.	MR16	MR15	MR14	MR13	MR12	MR11 ... MR1	MR0	NOTE
0	A/B	s	MSb				lsb	
default	0	0	1	0	0		0	¹⁾

Notes:

- ¹⁾ - All measurements are performed in channel A therefore MR16 must be set to zero. When channel B is selected no interrupt will be generated.
 - The signed value is used. For positive THR values the ASSP will initiate an interrupt whenever the measured value is bigger than the THR value. For negative THR values the interrupt will be generated for a negative result with an absolute value bigger than the absolute value of the THR register.

7.5.9 MSR measurement result register (18 bits)

Nr.	MR17	MR16	MR15	MR14	MR13	MR12	MR11 ... MR1	MR0	NOTE
	Overflow/underflow	A/B	S	msb				lsb	¹⁾

Notes:

- ¹⁾ - Result word length is 16 bits because of calibration accuracy and to maintain all possible resolutions (different setting).
 - A/B bit signifies which measurement was performed: the one defined in CRA or CRB:
 MR16=0 -> A
 MR16=1 -> B
 - Overflow/underflow bit is set whenever the result after multiplication by calibration constant is bigger than 32767 or smaller than -32767.
 In Wake-up or Alarm mode the overflow/underflow always sets INTN signal to LO.

8 Digital interface description

The digital interface of the AS8501 consists of two input pins (CLK and SCLK) and two I/O pins (INTN and SDAT). The SCLK and SDAT pins are used as universal serial data interface (SDI). SDI operates only if external clock signal (CLK) is running.

8.1 CLK

In all operating modes except the Wake-up mode this pin must be connected to 8 MHz clock signal. In the Wake-up mode (MWU) the CLK pin must be connected to logic HI or float.

8.2 INTN

The INTN pin is used to signal various conditions to the microcontroller, depending on the operating mode.

application modes of the INTN pin

Mode	Signal	Direction	Purpose	Note
0	Load clock (internal)	Output	Indicates progress of the Zener-Zap load process	¹⁾
1, 2, 7	SDI clock disable	Output	Signals new result and suggests when to disable SCLK in high-precision measurement phase	²⁾
3	idle / wake-up not	Output	Signals the wake-up condition	
4	idle / alarm not	Output	Signals the alarm condition	
5	PW1	Input	Shows the programming pulse width	
6, 8, 9	Logic '0'	Output	No purpose	
10	t12	Output	Test mode	
10	t18	Output	Test mode	

Notes:

- ¹⁾ 188 clock pulses are generated from the internal oscillator source during the loading time.
²⁾ In measurement modes (MMS and MMD) the INTN pin is used to synchronize the SDI bus operations (See Fig. 9). The trailing edge of INTN signals the start of a new measurement.

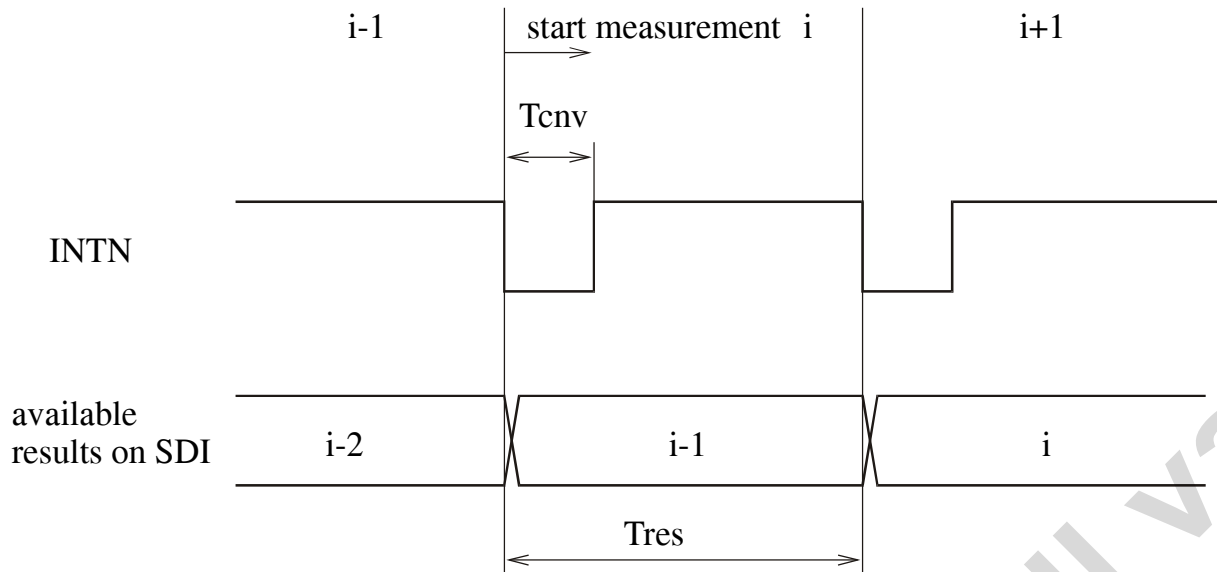

Figure 9: INTN pin in modes 1 and 2

The determination of Tcnv and Tres from the parameter settings is:

$$T_{cnv} \cong R1 / (f_{ovs} * 2) \quad T_{res} = MM * T_{cnv} * R2 * 2 \quad \text{with } R1 = OSR \text{ and } R2 = \text{number of averages}$$

8.3 SDI bus operation

SDI bus is a 2-line bi-directional interface between one master and one slave unit. Typically the master unit is a microcontroller with software-implemented SDI protocol. The ASSP is always the slave unit. SDI bus operation is presented on Figure 10.

During data transfers the **sd**at signal changes while **s**clk is low. The **sd**at signal can change while **s**clk is high only to generate **start** or **exception** conditions.

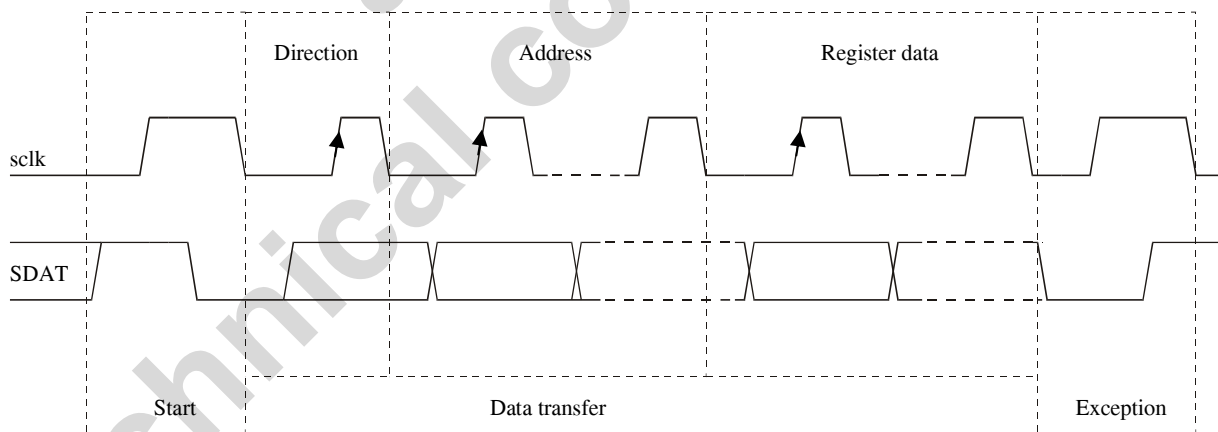

Figure 10: SDI bus operation

→ Strobe ASSP

The master unit always generates the sclk signal.

The master unit generates the sd at signal in **start**, **direction**, **address**, **master-write data** and **exception** conditions. The master sd at pin is in high-impedance state in **master-read data** condition.

The slave unit drives the sd at signal **only** in master-read data condition. In all other cases the slave sd at pin is in high-impedance state. During data transfer in read condition the internal AD-conversion is continuing but the data in the MSR-register is not updated and the output of the

INTN signal is suppressed. Only after the completion of the reading cycle the ASSP returns to the normal condition and updates the MSR-register immediately if a new AD-conversion has been finished during data transfer.

The master unit does not detect any bus conditions since it generates them. Data transfer conditions (direction, register address and register data) must not be changed until the current condition is over. The slave unit does not detect start and exception condition when master-read is in progress.

The exception condition is reserved for future use and should be avoided.

8.4 Data transfers

Generally the SDI interface is active in all ASSP modes. For security reasons some write operations are restricted to certain modes. Read operations are never disabled in order to keep consistent sdat driving conditions.

Writing to the result, trimming and calibration registers (MSR, CAR and TRR) is allowed only in test modes.

Writing to the Zener-Zap register is allowed only in mode MZP.

The first data bit after the start condition in each data transfer defines the data direction: sdat=high is used for **master-read data** (mr) condition and sdat=low for **master-write data** (mw) condition.

Data is transferred with the most significant bit (MSB) first. Data bits are composed of register address and register data bits. Register address is transmitted first, followed by the register data bits. The register address is always 4 bits long. The number of register data bits in table 7.5 is implied by the register address.

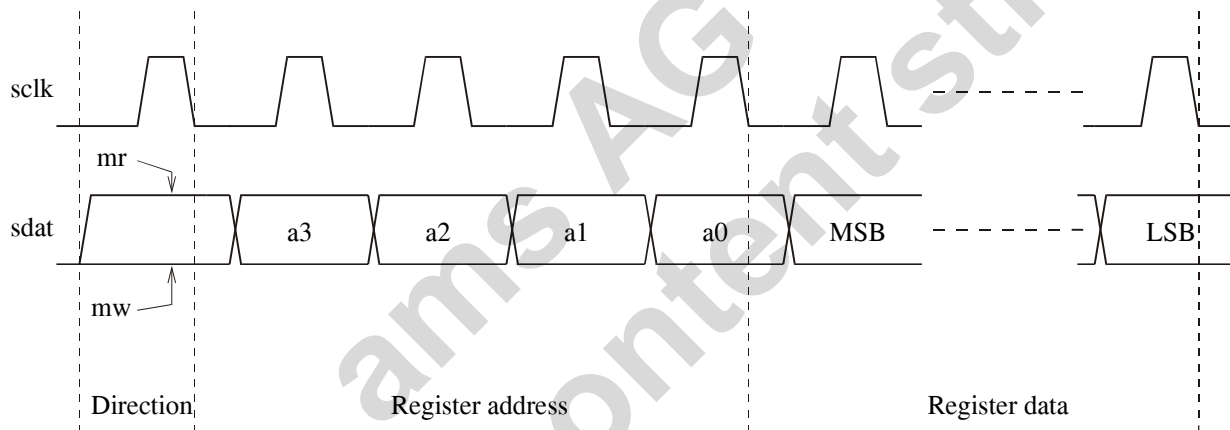

Figure 11: SDI Data transfer

The ASSP supports the data transfers presented in Table 8.1.

master read-write operations

REGISTER	ADDRESS	Contents	read allowed in modes	write allowed in modes	page
OPM	0	operating mode	All	All	
CRA	1	measurement set-up A	All	All	
CRB	2	measurement set-up B	All	All	
CRG	3	general measurement conditions	All	All	
MSR	4	measurement result	All	>7	
ZZR	5	Zener-Zap data	All	5	
CAR	6	calibration register	All	>7	
TRR	7	trimming register	All	>7	
THR	8	alarm or wake-up threshold register	All	All	

SDI bus timing

Nr.	PARAMETER	SYMBOL	MIN	TYP	MAX	Unit	Conditions	NOTE
0	SCLK pulse width	PW_sclk	120			ns	All	
1	SCLK low	LO_sclk	120			ns	All	5), 6)
2	Master SDAT exception after SCLK	MDE	120			ns	All	
3	Master SDAT valid before/after SCLK	DV_m	120	TSW		ns	All	1)
4	Slave SDAT not valid after SCLK	DV_s			120	ns	Master read	
5	Master 3-state ON/OFF	TS_m	TS_s	TSW		ns	Master read	
6	Slave 3-state ON/OFF	TS_s			120	ns	Master read	
7	Bus condition detection disabled in slave unit	CDD				ns	Master read	3)

Notes:

1) TSW is typical time required by the microcontroller program to change or to read the state of the I/O pin

3) Start detection is disabled when slave unit transmits data

5) LO_sclk > 300ns and PW_sclk > 2µsec required to read ZZR.

6) LO_sclk > (3/2) * T_{CLK} = (3/2) / f_{CLK} = (3/2) / 8MHz = 187.5ns required for results synchronisation in MSR.

8.6 SDI access to OTP memory

SDI can read the OTP memory in any mode by reading the register ZZR.

8.6.1 ZZR register bit mapping

Cell index	0	1	2	3	4	5	6	7
Purpose	pos A ¹⁾	pos B ²⁾	pos C ³⁾	lock A ⁴⁾	lock B ⁵⁾	trimcs	trimc3	trimc2
ZZR field	ZLO	ZLO	ZLO	ZLO	ZLO	ZTR	ZTR	ZTR
ZZR bit	187 (msb)	186	185	184	183	182	181	180

1) Always programmed to '0' during the production test

2) Always programmed to '0' during the production test

3) Always programmed to '1' during the production test

4) Reserved

5) Reserved

Cell index	8	9	10	11	12	13	14	15
Purpose	trimc1	trimc0	trimas	trima3	trima2	trima1	trima0	trimbvs
ZZR field	ZTR	ZTR	ZTR	ZTR	ZTR	ZTR	ZTR	ZTR
ZZR bit	179	178	177	176	175	174	173	172

Cell index	16	17	18	19	20	21	22	23
Purpose	trimbv3	trimbv2	trimbv1	trimbv0	trimbtc5	trimbtc3	trimbtc2	trimbtc1
ZZR field	ZTR	ZTR	ZTR	ZTR	ZTR	ZTR	ZTR	ZTR
ZZR bit	171	170	169	168	167	166	165	164

Cell index	24	25	26	27	28	29	30	31
Purpose	trimbtc0	cgj1_10	cgj1_9	cgj1_8	cgj1_7	cgj1_6	cgj1_5	cgj1_4
ZZR field	ZTR	ZCL	ZCL	ZCL	ZCL	ZCL	ZCL	ZCL
ZZR bit	163	162	161	160	159	158	157	156

Cell index	32	33	34	35	36	37	38	39
Purpose	cgj1_3	cgj1_2	cgj1_1	cgj1_0	cgj2_10	cgj2_9	cgj2_8	cgj2_7
ZZR field	ZCL	ZCL	ZCL	ZCL	ZCL	ZCL	ZCL	ZCL
ZZR bit	155	154	153	152	151	150	149	148

Cell index	40	41	42	43	44	45	46	47
Purpose	cgj2_6	cgj2_5	cgj2_4	cgj2_3	cgj2_2	cgj2_1	cgj2_0	cgj3_10
ZZR field	ZCL	ZCL	ZCL	ZCL	ZCL	ZCL	ZCL	ZCL
ZZR bit	147	146	145	144	143	142	141	140

Cell index	48	49	50	51	52	53	54	55
Purpose	cgj3_9	cgj3_8	cgj3_7	cgj3_6	cgj3_5	cgj3_4	cgj3_3	cgj3_2
ZZR field	ZCL	ZCL	ZCL	ZCL	ZCL	ZCL	ZCL	ZCL
ZZR bit	139	138	137	136	135	134	133	132

Cell index	56	57	58	59	60	61	62	63
Purpose	cgj3_1	cgj3_0	cgj4_10	cgj4_9	cgj4_8	cgj4_7	cgj4_6	cgj4_5
ZZR field	ZCL	ZCL	ZCL	ZCL	ZCL	ZCL	ZCL	ZCL
ZZR bit	131	130	129	128	127	126	125	124

Cell index	64	65	66	67	68	69	70	71
Purpose	cgj4_4	cgj4_3	cgj4_2	cgj4_1	cgj4_0	cau0_10	cau0_9	cau0_8
ZZR field	ZCL	ZCL	ZCL	ZCL	ZCL	ZCL	ZCL	ZCL
ZZR bit	123	122	121	120	119	118	117	116

Cell index	72	73	74	75	76	77	78	79
Purpose	cau0_7	cau0_6	cau0_5	cau0_4	cau0_3	cau0_2	cau0_1	cau0_0
ZZR field	ZCL	ZCL	ZCL	ZCL	ZCL	ZCL	ZCL	ZCL
ZZR bit	115	114	113	112	111	110	109	108

Cell index	80	81	82	83	84	85	86	87
Purpose	cau1_10	cau1_9	cau1_8	cau1_7	cau1_6	cau1_5	cau1_4	cau1_3
ZZR field	ZCL	ZCL	ZCL	ZCL	ZCL	ZCL	ZCL	ZCL
ZZR bit	107	106	105	104	103	102	101	100

Cell index	88	89	90	91	92	93	94	95
Purpose	cau1_2	cau1_1	cau1_0	cau2_10	cau2_9	cau2_8	cau2_7	cau2_6
ZZR field	ZCL	ZCL	ZCL	ZCL	ZCL	ZCL	ZCL	ZCL
ZZR bit	99	98	97	96	95	94	93	92

Cell index	96	97	98	99	100	101	102	103
Purpose	cau2_5	cau2_4	cau2_3	cau2_2	cau2_1	cau2_0	cau3_10	cau3_9
ZZR field	ZCL	ZCL	ZCL	ZCL	ZCL	ZCL	ZCL	ZCL
ZZR bit	91	90	89	88	87	86	85	84

Cell index	104	105	106	107	108	109	110	111
Purpose	cau3_8	cau3_7	cau3_6	cau3_5	cau3_4	cau3_3	cau3_2	cau3_1
ZZR field	ZCL	ZCL	ZCL	ZCL	ZCL	ZCL	ZCL	ZCL
ZZR bit	83	82	81	80	79	78	77	76

Cell index	112	113	114	115	116	117	118	119
Purpose	cau3_0	cau4_10	cau4_9	cau4_8	cau4_7	cau4_6	cau4_5	cau4_4
ZZR field	ZCL	ZCL	ZCL	ZCL	ZCL	ZCL	ZCL	ZCL
ZZR bit	75	74	73	72	71	70	69	68

Cell index	120	121	122	123	124	125	126	127
Purpose	cau4_3	cau4_2	cau4_1	cau4_0	cau5_10	cau5_9	cau5_8	cau5_7
ZZR field	ZCL	ZCL	ZCL	ZCL	ZCL	ZCL	ZCL	ZCL
ZZR bit	67	66	65	64	63	62	61	60

Cell index	128	129	130	131	132	133	134	135
Purpose	cau5_6	cau5_5	cau5_4	cau5_3	cau5_2	cau5_1	cau5_0	tcu1_8
ZZR field	ZCL	ZCL	ZCL	ZCL	ZCL	ZCL	ZCL	ZTC
ZZR bit	59	58	57	56	55	54	53	52

Cell index	136	137	138	139	140	141	142	143
Purpose	tcu1_7	tcu1_6	tcu1_5	tcu1_4	tcu1_3	tcu1_2	tcu1_1	tcu1_0
ZZR field	ZTC	ZTC	ZTC	ZTC	ZTC	ZTC	ZTC	ZTC
ZZR bit	51	50	49	48	47	46	45	44

Cell index	144	145	146	147	148	149	150	151
Purpose	tcu0_8	tcu0_7	tcu0_6	tcu0_5	tcu0_4	tcu0_3	tcu0_2	tcu0_1
ZZR field	ZTC	ZTC	ZTC	ZTC	ZTC	ZTC	ZTC	ZTC
ZZR bit	43	42	41	40	39	38	37	36

Cell index	152	153	154	155	156	157	158	159
Purpose	tcu0_0	trt0_10	trt0_9	trt0_8	trt0_7	trt0_6	trt0_5	trt0_4
ZZR field	ZTC	ZTC	ZTC	ZTC	ZTC	ZTC	ZTC	ZTC
ZZR bit	35	34	33	32	31	30	29	28

Cell index	160	161	162	163	164	165	166	167
Purpose	trt0_3	trt0_2	trt0_1	trt0_0	tcn3_7	tcn3_6	tcn3_5	tcn3_4
ZZR field	ZTC	ZTC	ZTC	ZTC	ZTC	ZTC	ZTC	ZTC
ZZR bit	27	26	25	24	23	22	21	20

Cell index	168	169	170	171	172	173	174	175
Purpose	tcn3_3	tcn3_2	tcn3_1	tcn3_0	tcn2_7	tcn2_6	tcn2_5	tcn2_4
ZZR field	ZTC	ZTC	ZTC	ZTC	ZTC	ZTC	ZTC	ZTC
ZZR bit	19	18	17	16	15	14	13	12

Cell index	176	177	178	179	180	181	182	183
Purpose	tcn2_3	tcn2_2	tcn2_1	tcn2_0	tcn1_7	tcn1_6	tcn1_5	tcn1_4
ZZR field	ZTC	ZTC	ZTC	ZTC	ZTC	ZTC	ZTC	ZTC
ZZR bit	11	10	9	8	7	6	5	4

Cell index	184	185	186	187
Purpose	tcn1_3	tcn1_2	tcn1_1	tcn1_0
ZZR field	ZTC	ZTC	ZTC	ZTC
ZZR bit	3	2	1	0

8.6.2 Stored ZZR-register mapping

ZZR-Register

ZZR	subregister	bit no. in subregister										ZZR-bits	remarks			
		10	9	8	7	6	5	4	3	2	1			0		
		msb lsb														
ZLO								x	x	x	x	x	187	183		
ZTR	TRIMC							x	x	x	x	x	182	178	current source calibration	
	TRIMA							x	x	x	x	x	177	173	PGA offset calibration	
	TRIMBV							x	x	x	x	x	172	168	reference voltage calibration	
	TRIMBTC							x	x	x	x	x	167	163	TC calibration	
ZCL	CGI1	c0	c0	c0	c0	c0	c0	c0	c0	c0	c0	c0	162	152	gain 6 current 1500A	
	CGI2	c1	c1	c1	c1	c1	c1	c1	c1	c1	c1	c1	151	141	gain 24 current 300 A	
	CGI3	c2	c2	c2	c2	c2	c2	c2	c2	c2	c2	c2	140	130	gain 50 current 150 A	
	CGI4	0	0	0	0	0	0	0	0	0	0	0	129	119	gain100 current 75 A	
	CAU0	c1	c1	c1	c1	c1	c1	c1	c1	c1	c1	c1	118	108	calibration factor for gain 24	
	CAU1	1	1	1	1	1	1	1	1	1	1	1	107	97		
	CAU2	1	1	1	1	1	1	1	1	1	1	1	96	86		
	CAU3	c4	c4	c4	c4	c4	c4	c4	c4	c4	c4	c4	85	75		calibration factor for gain 1
	CAU4	c3	c3	c3	c3	c3	c3	c3	c3	c3	c3	c3	74	64		calibration factor for gain 100
	CAU5	ct	ct	ct	ct	ct	ct	ct	ct	ct	ct	ct	63	53	calibration factor for internal temperature	
ZTC	TCU1		1	cs	cs	cs	cs	cs	cs	cs	cs	cs	52	44	8 bits for checksum ¹⁾	
	TCU0		1	1	1	fi	fi	fi	fi	fi	fi	fi	43	35	6 bits for internal clock ²⁾	
	TRT0	t	t	t	t	t	t	t	t	t	t	t	34	24	11 bits for internal temperature at 23°C	
	TCN3			n23	n	n	n	n	n	n	n	n	23	16	high byte for serial number	
	TCN2				n	n	n	n	n	n	n	n	15	8	medium byte for serial number	
	TCN1					n	n	n	n	n	n	n0	7	0	low byte for serial number	

- x = these fields are written during calibration
- c0 = these fields are written during calibration of G6
- c1 = these fields are written during calibration of G24 (i.e. 30 mV = 30 000 digits)
- 0 = Zero value of calibration constant for detection of unwanted POR
- ct = calibration factor for slope of Tint : 75 digits/deg
- cs = 8-Bit checksum for ZZR-register
- fi = 6-bit for calibration of internal clock
- t = 11 bits for Tint value at 23 °C
- nr = 24 bits serial number

Notes:

- ¹⁾ The checksum contains the added value of all bits in the ZZR register without the 6 checksum bits
- ²⁾ The internal clock frequency can be calculated $int_fclk = (240 + 6\text{-bit } fi\text{-number}) \text{ kHz}$

9 General application hints

Since the AS8501 is optimised for low voltage applications extreme care should be taken that the signal is not disturbed by influences like bad ground reference, external noise pick-up, thermal EMFs generated at the transition of different materials or ground loops. The influence of these error sources can be quite high and they may completely shadow the excellent properties of the device if not handled properly. The following sections are supposed to supply additional informations to the design engineer how to get around some of these problems.

9.1 Ground connection, analog common

The analog common terminal where all voltages are referring to is RSHL. All ground lines of the external circuitry of VBAT, ETS and ETR as well as the voltage sense line of the low ohmic current sensing resistor should be connected to each other in a star like ground point. It is recommended that this point is as close as possible situated to the low side sense terminal of the current sensing resistor. It should also be connected to the VSS and VSSD terminal, but the return line of both must leave this point separately. Also the power decoupling capacitors should be connected to the analog common. To give an example of the magnitude of possible errors consider that the ground return of the power supply is not connected properly and 5 mm of a copper track 35µm thick and 0.1 mm wide are within the measuring circuit with a current flow of 5 mA. This will result in an offset of 120 µV which is more than 500 times higher than the typical offset of the ASSP. In addition the current fluctuations will act as an extra noise voltage which is also way above that of the device itself.

9.2 Thermal EMF

another major source of error for low level measurements are thermal voltages (electromotive force, thermal EMF) or Seebeck voltages which are principally produced by any junction of two dissimilar materials. On PC-boards pairs of dissimilar materials may consist of the copper tracks and the solder, the leads of different components or different materials used in the construction within the components. Any temperature difference between two connection produces a voltage which is superimposed to the measuring voltage.

A number of strategies are known to detect or minimise their influence on the measuring result:

- in cases where a current has to be measured directly or a current is to be used to activate a resistive sensor (like Ohm-meter or temperature measurement with RTDs, NTC or PTC) a switch in the circuit could be used to interrupt or invert the current thus producing a current change dI . In the difference of the two voltage states dU the EMFs as well as the Offset voltages of the amplifier are fully eliminated. For resistance measurements this method is known as 'true Ohm' measurement.
- in applications where this is not possible and the problematic device (i.e. the input resistor of an amplifier) can be located it may help to place a dummy device of the same type in the circuit as close and thermally connected as good as possible to compensate the influence of the first one.
- Since the thermal EMFs are proportional to the temperature difference it is important to maintain a homogeneous temperature distribution in the vicinity of the sensitive area. This is possible by keeping this area as small as possible, by avoiding any heat sources nearby or by increasing the heat conductivity of the substrate, i.e. wide and thick copper tracks, multilayer board or even metal substrate.
- The best solution of all however is to avoid the thermal EMFs by using only components which are matched to the copper world which means that their thermo-electrical power against copper is zero. This is specially important for current measurements in the range of 10- 1000A. In this case the resistance value has to be very low (down to 100µ Ohms) to limit the measuring power and avoid an overheating of the sensing resistor. On the other hand the voltages to be detected are extremely low if a high resolution is required. If for instance a current of 10 mA has to be measured with a 100µ Ohm resistor, the resolution of the measuring system must be better than 1µV and the error voltages due to thermal EMFs must be below this limit. Quite often people are trying to use the well known Konstantan (CuNi44) for current sensing resistors. This is a bad choice since the thermal EMF versus copper is very high.

With $-40\mu\text{V/deg}$ already a temperature difference of

2.5 K is enough to produce an error which is 100 times larger than the required resolution. Or vice versa a temperature fluctuation of only 1/100 K produces a 'thermal noise' which is equivalent to the required resolution.

With such materials and high currents of 10A and above the other thermoelectric effect, the so called Peltier-effect, can also play an important role. Under current flow this effect generates heat in one junction and destroys the same amount of heat in the other junction. The amount of heat is proportional to the current and its direction. The result is a temperature difference which in turn generates a thermal EMF proportional to it. Finally this means that such a resistor produces its own error voltage and it is never possible to measure better than 1-2% with such badly matched materials. The precision resistance materials Manganin, Zeranin and Isohm are perfectly matched to the copper world and resistors made from these materials can achieve the high quality that is necessary for low

level measurements and high resolution.

9.3 Noise considerations

for every low level measuring system it is essential to know the origin of noise and to accept the limitations given by it. Three major sources of noise have to be considered. The input voltage noise and the input current noise of the amplifier and the thermal noise (Johnson noise) of resistors in the external circuitry around the amplifier. Due to the fact that these three sources are not correlated they can be added in the well known square root equation.

In most applications the input resistor or input divider is low ohmic (i.e. below 10 kOhms) which mean that the noise voltage produced by the input current noise is negligible compared to the input voltage noise. The input noise density (E_n) of the AS8501 is with only 35 nV/sqr(Hz) extremely low. This could be achieved with a special internal analog and digital chopper circuitry which eliminates the CMOS typical 1/f-noise completely. Even though the overall noise will be dominated by the input amplifier as long as the external resistors are below 10 kOhm.

The total noise voltage generated at a given frequency resp. in a given frequency band (BW) is given by:

$$U_n = E_n \cdot \sqrt{BW}$$

This square root dependence can be seen very nicely in fig. 9.10. The typical square-root shaped dependence is found for both the peak to peak noise as well as for the equivalent RMS noise.

The bandwidth resp. the sampling frequency of the AS8501 can be adapted to the requirements of the application by programming the internal digital filter via the SDI bus. For a sampling frequency of 16kHz the input voltage RMS noise is less than 5 μ V, whereas at 500 Hz already 1 μ V (or 1LSB) is reached.

If the customer needs even higher resolution at a lower measuring speed the internal integration time can be further increased but due to the limitation of the digital noise (1LSB) it is better to perform an external averaging in the attached μ C. In this way the resolution of the system can be considerably increased to less than 0.1 μ V for sampling rates of 5 Hz and below which corresponds to an effective AD-converter width of more than 20 bits. (see fig. 9.10)

9.4 Shielding, guarding

In many applications it is difficult to gain full benefit from the AS8501 performance since a number of external error sources can disturb the measurement. To achieve the maximum performance the design engineer has to take care specially of the layout of the PC-board and the sense connections to the external components. To avoid noise pick-up from external magnetic fields all tracks on the PC-board should be parallel strip lines and they should be traced as close as possible to each other. External sensing cables should be twisted and kept away from current carrying cables as far as possible. For longer cables a shielding is sometimes helpful but care should be taken that the shield is not connected to one of the sense leads. For an optimum performance it should be open on one side, the other side should be connected to the central (star like) analog common point.

In very sensitive applications it may be wise to use a guard ring around both inputs and it should be connected again to the analog common point. This procedure minimises leakage currents and parasitic capacitances between different terminals and components on the PC-board.

EMV interferences can be affectively avoided in most cases by using standard SMD-type high frequency filters in the analog input lines as well as in the digital output lines.

10 Typical performance characteristics

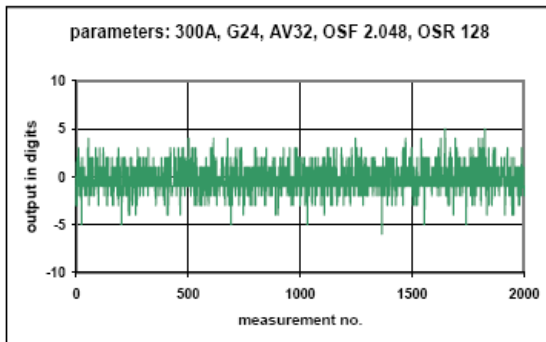

Figure 13: Resolution and noise at zero input, sampling rate: 1kHz

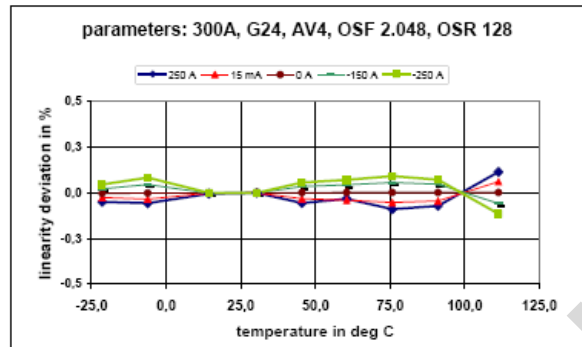

Figure 14: Linearity deviation for different currents over temperature

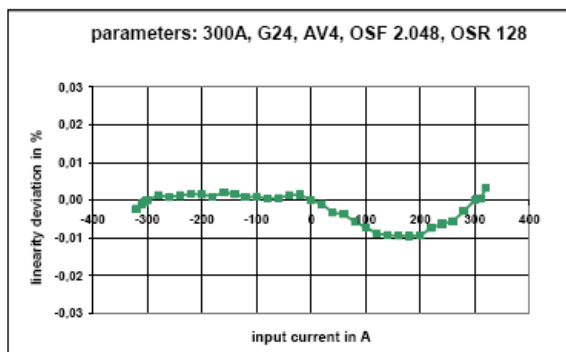

Figure 15: Linearity deviation over input signal

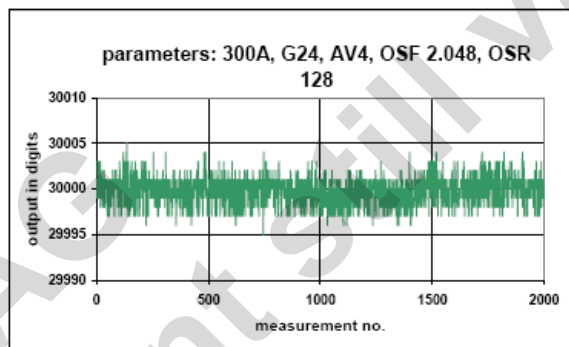

Figure 16: Resolution and noise at 95% full scale, sampling rate: 1kHz

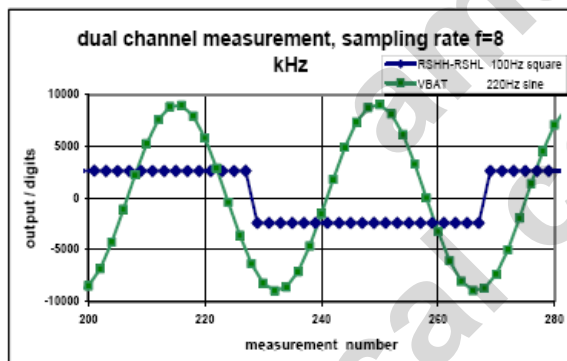

Figure 17: Dual mode measurement

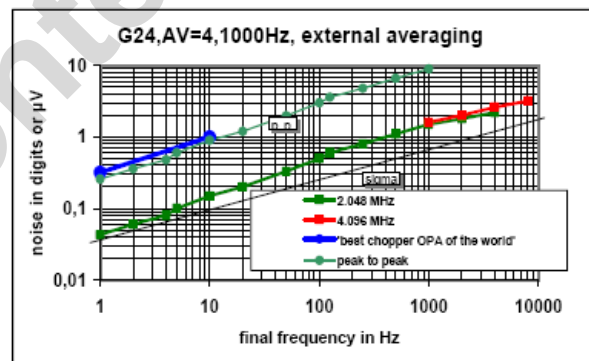

Figure 18: Output voltage noise over sampling rate

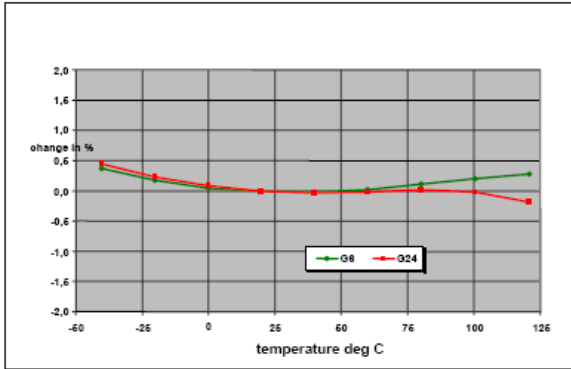

Figure 19: Typical output as function of temperature for gains 6 and 24

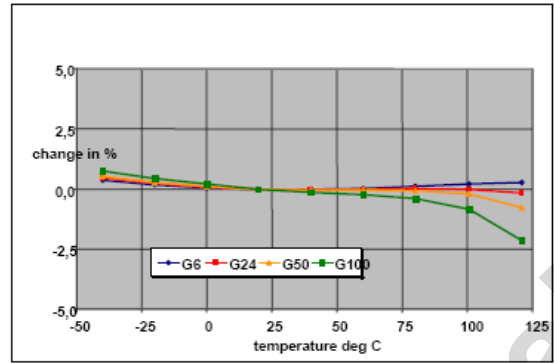

Figure 22: Typical output as function of temperature for all gains

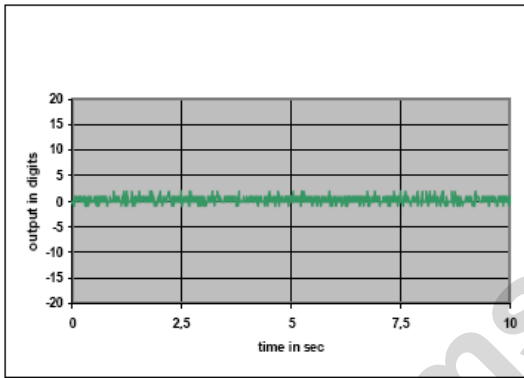

Figure 23: Noise at 125 Hz sampling rate, gain 24

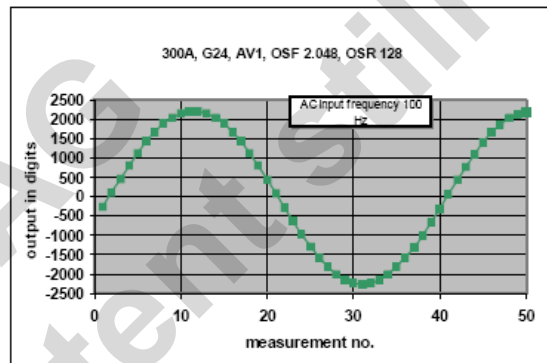

Figure 20: Real time AC measurement at 100 Hz

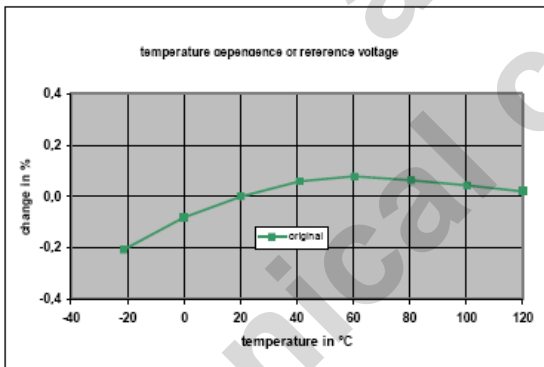
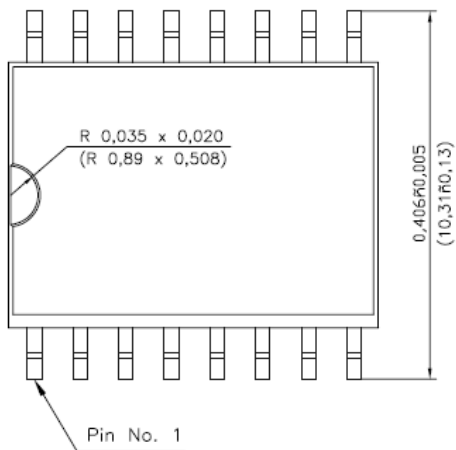
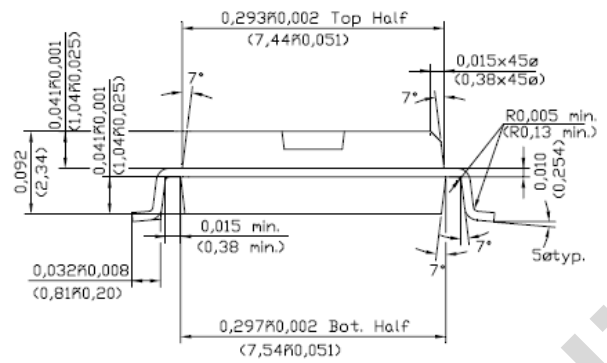
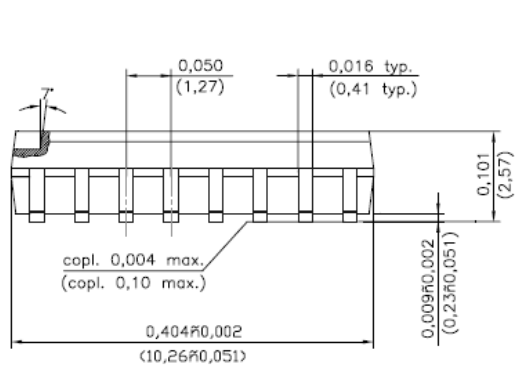

Figure 21: temperature dependence of internal reference voltage (not trimmed)

Package Dimensions



Thermal Resistance junction / ambient.: 66 K/W (typ.) in still air

11 Revision History

Revision	Date	Description
1.0	Feb.10,2006	Initial Revision
1.1	March 23, 2006	R _{thJA}

12 Ordering Information

Delivery in Tape and Reel (1 reel = 1500 devices)
 Order AS8501 T&R

Delivery in Tubes (1 Tube = 46 devices)
 Order AS8501 TUB

13 Contact**13.1 Headquarters**

austriamicrosystems AG
 A 8141 Schloss Premstätten, **Austria**
 Phone: +43 3136 500 0
 Fax: +43 3136 525 01
industry.medical@austriamicrosystems.com
www.austriamicrosystems.com

13.2 Sales Offices

austriamicrosystems Germany GmbH
 Tegenseer Landstrasse 85
 D-81539 München, **Germany**
 Phone: +49 89 69 36 43 0
 Fax: +49 89 69 36 43 66

austriamicrosystems Italy S.r.l.
 Via A. Volta, 18
 I-20094 Corsico (MI), **Italy**
 Phone: +39 02 4586 4364
 Fax: +39 02 4585 773

austriamicrosystems France S.A.R.L.
 124, Avenue de Paris
 F-94300 Vincennes, **France**
 Phone: +33 1 43 74 00 90
 Fax: +33 1 43 74 20 98

austriamicrosystems Switzerland AG
 Rietstrasse 4
 CH 8640 Rapperswil, **Switzerland**
 Phone: +41 55 220 9008
 Fax: +41 55 220 9001

austriamicrosystems UK, Ltd.
 88, Barkham Ride,
 Finchampstead, Wokingham
 Berkshire RG40 4ET, **United Kingdom**
 Phone: +44 118 973 1797
 Fax: +44 118 973 5117

austriamicrosystems AG
 Klaavuntie 9 G 55
 FI 00910 Helsinki, **Finland**
 Phone: +358 9 72688 170
 Fax: +358 9 72688 171

austriamicrosystems AG
 Bivågen 3B
 S 19163 Sollentuna, **Sweden**
 Phone: +46 8 6231 710

austriamicrosystems USA, Inc.
 8601 Six Forks Road
 Suite 400
 Raleigh, NC 27615, **USA**
 Phone: +1 919 676 5292
 Fax: +1 509 696 2713

austriamicrosystems USA, Inc.
 4030 Moorpark Ave
 Suite 116
 San Jose, CA 95117, **USA**
 Phone: +1 408 345 1790
 Fax: +1 509 696 2713

austriamicrosystems AG
 Suite 811, Tsimshatsui Centre
 East Wing, 66 Mody Road
 Tsim Sha Tsui East, Kowloon, **Hong Kong**
 Phone: +852 2268 6899
 Fax: +852 2268 6799

austriamicrosystems AG
 AIOS Gotanda Annex 5th Fl., 1-7-11,
 Higashi-Gotanda, Shinagawa-ku
 Tokyo 141-0022, **Japan**
 Phone: +81 3 5792 4975
 Fax: +81 3 5792 4976

austriamicrosystems AG
 #805, Dong Kyung Bldg.,
 824-19, Yeok Sam Dong,
 Kang Nam Gu, Seoul
Korea 135-080
 Phone: +82 2 557 8776
 Fax: +82 2 569 9823

austriamicrosystems AG
 Singapore Representative Office
 83 Clemenceau Avenue, #02-01 UE Square
 239920, **Singapore**
 Phone: +65 68 30 83 05
 Fax: +65 62 34 31 20

Disclaimer

Devices sold by austriamicrosystems AG are covered by the warranty and patent identification provisions appearing in its Term of Sale. austriamicrosystems AG makes no warranty, express, statutory, implied, or by description regarding the information set forth herein or regarding the freedom of the described devices from patent infringement. austriamicrosystems AG reserves the right to change specifications and prices at any time and without notice. Therefore, prior to designing this product into a system, it is necessary to check with austriamicrosystems AG for current information. This product is intended for use in normal commercial applications. Applications requiring extended temperature range, unusual environmental requirements, or high reliability applications, such as military, medical life-support or life-sustaining equipment are specifically not recommended without additional processing by austriamicrosystems AG for each application. The information furnished here by austriamicrosystems AG is believed to be correct and accurate. However, austriamicrosystems AG shall not be liable to recipient or any third party for any damages, including but not limited to personal injury, property damage, loss of profits, loss of use, interruption of business or indirect, special, incidental or consequential damages, of any kind, in connection with or arising out of the furnishing, performance or use of the technical data herein. No obligation or liability to recipient or any third party shall arise or flow out of austriamicrosystems AG rendering of technical or other services.

Copyright

Devices sold by austriamicrosystems are covered by the warranty and patent indemnification provisions appearing in its Term of Sale. austriamicrosystems makes no warranty, express, statutory, implied, or by description regarding the information set forth herein or regarding the freedom of the described devices from patent infringement. austriamicrosystems reserves the right to change specifications and prices at any time and without notice. Therefore, prior to designing this product into a system, it is necessary to check with austriamicrosystems for current information. This product is intended for use in normal commercial applications.

Copyright © 2004 austriamicrosystems. Trademarks registered ®. All rights reserved. The material herein may not be reproduced, adapted, merged, translated, stored, or used without the prior written consent of the copyright owner. To the best of its knowledge, austriamicrosystems asserts that the information contained in this publication is accurate and correct. However, austriamicrosystems shall not be liable to recipient or any third party for any damages, including but not limited to personal injury, property damage, loss of profits, loss of use, interruption of business or indirect, special, incidental or consequential damages, of any kind, in connection with or arising out of the furnishing, performance or use of the technical data herein. No obligation or liability to recipient or any third party shall arise or flow out of austriamicrosystems rendering of technical or other services.