

PHASE CONTROL THYRISTOR

AT1004

Repetitive voltage up to **1600 V**
Mean on-state current **1545 A**
Surge current **24.6 kA**

FINAL SPECIFICATION

feb 97 - ISSUE : 06

Symbol	Characteristic	Conditions	T _j [°C]	Value	Unit
BLOCKING					
V _{RRM}	Repetitive peak reverse voltage		125	1600	V
V _{RSM}	Non-repetitive peak reverse voltage		125	1700	V
V _{DRM}	Repetitive peak off-state voltage		125	1600	V
I _{RRM}	Repetitive peak reverse current	V=VRRM	125	50	mA
I _{DRM}	Repetitive peak off-state current	V=VDRM	125	50	mA
CONDUCTING					
I _{T(AV)}	Mean on-state current	180° sin, 50 Hz, Th=55°C, double side cooled		1545	A
I _{T(AV)}	Mean on-state current	180° sin, 50 Hz, Tc=85°C, double side cooled		1255	A
I _{TSM}	Surge on-state current	sine wave, 10 ms	125	24.6	kA
I ² t	I ² t	without reverse voltage		3026 x1E3	A ² s
V _T	On-state voltage	On-state current = 2900 A	25	1.63	V
V _{T(TO)}	Threshold voltage		125	0.92	V
r _T	On-state slope resistance		125	0.216	mohm
SWITCHING					
di/dt	Critical rate of rise of on-state current, min.	From 75% VDRM up to 1650 A, gate 10V 5ohm	125	200	A/μs
dv/dt	Critical rate of rise of off-state voltage, min.	Linear ramp up to 70% of VDRM	125	500	V/μs
t _d	Gate controlled delay time, typical	VD=100V, gate source 25V, 10 ohm, tr=.5 μs	25	1.1	μs
t _q	Circuit commutated turn-off time, typical	dV/dt = 20 V/μs linear up to 75% VDRM		250	μs
Q _{rr}	Reverse recovery charge	di/dt=-20 A/μs, I= 1080 A	125		μC
I _{rr}	Peak reverse recovery current	VR= 50 V			A
I _H	Holding current, typical	VD=5V, gate open circuit	25	300	mA
I _L	Latching current, typical	VD=5V, tp=30μs	25	700	mA
GATE					
V _{GT}	Gate trigger voltage	VD=5V	25	3.5	V
I _{GT}	Gate trigger current	VD=5V	25	300	mA
V _{GD}	Non-trigger gate voltage, min.	VD=VDRM	125	0.25	V
V _{FGM}	Peak gate voltage (forward)			30	V
I _{FGM}	Peak gate current			10	A
V _{RGM}	Peak gate voltage (reverse)			5	V
P _{GM}	Peak gate power dissipation	Pulse width 100 μs		150	W
P _G	Average gate power dissipation			2	W
MOUNTING					
R _{th(j-h)}	Thermal impedance, DC	Junction to heatsink, double side cooled		26	°C/kW
R _{th(c-h)}	Thermal impedance	Case to heatsink, double side cooled		6	°C/kW
T _j	Operating junction temperature			-30 / 125	°C
F	Mounting force			18.0 / 20.0	kN
	Mass			500	g

ORDERING INFORMATION : AT1004 S 16

standard specification VDRM&VRRM/100

DISSIPATION CHARACTERISTICS

SQUARE WAVE

Th [°C]

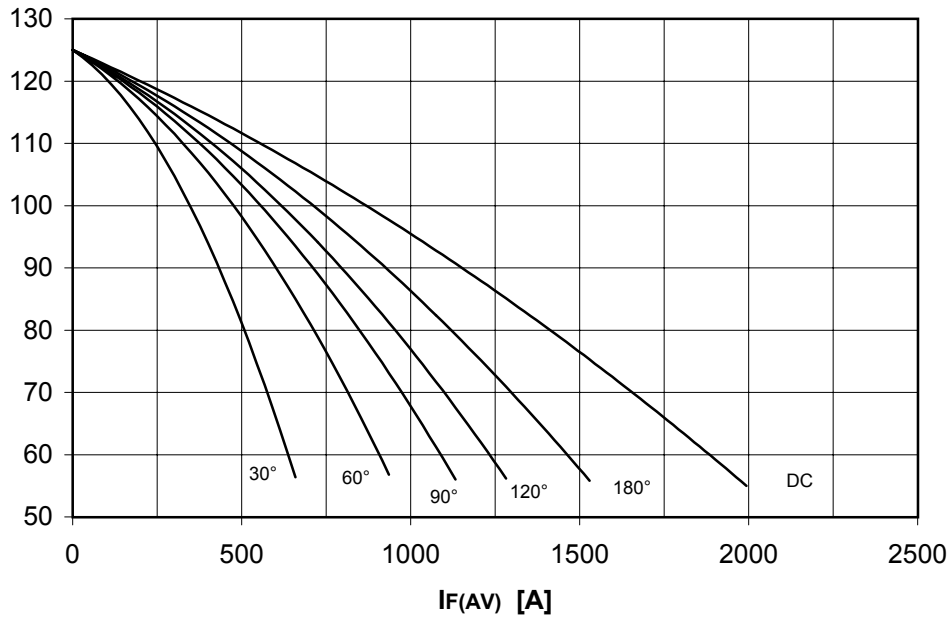

PF(AV) [W]

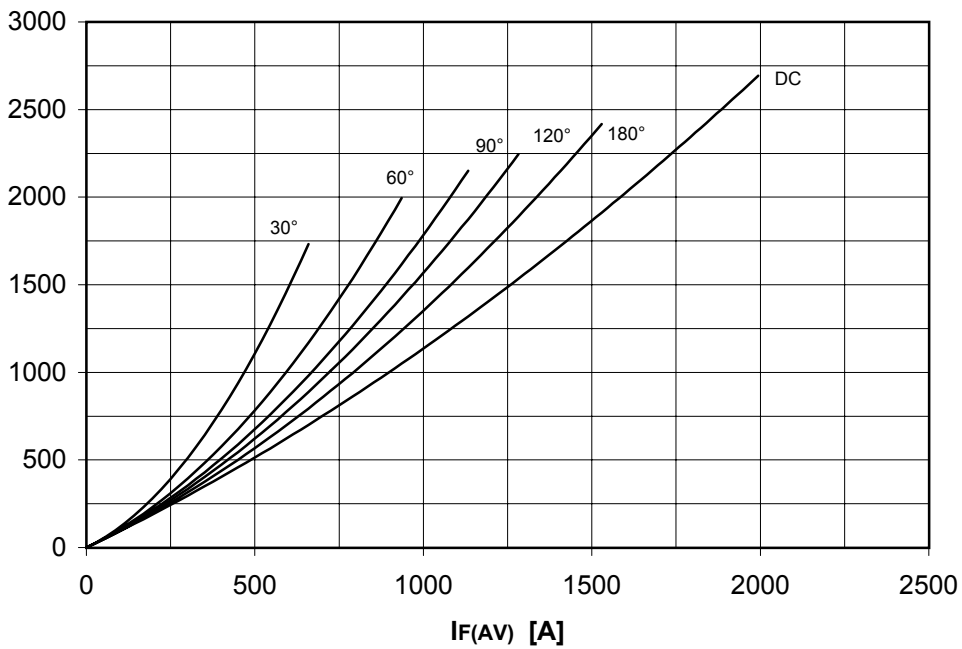

DISSIPATION CHARACTERISTICS

SINE WAVE

Th [°C]

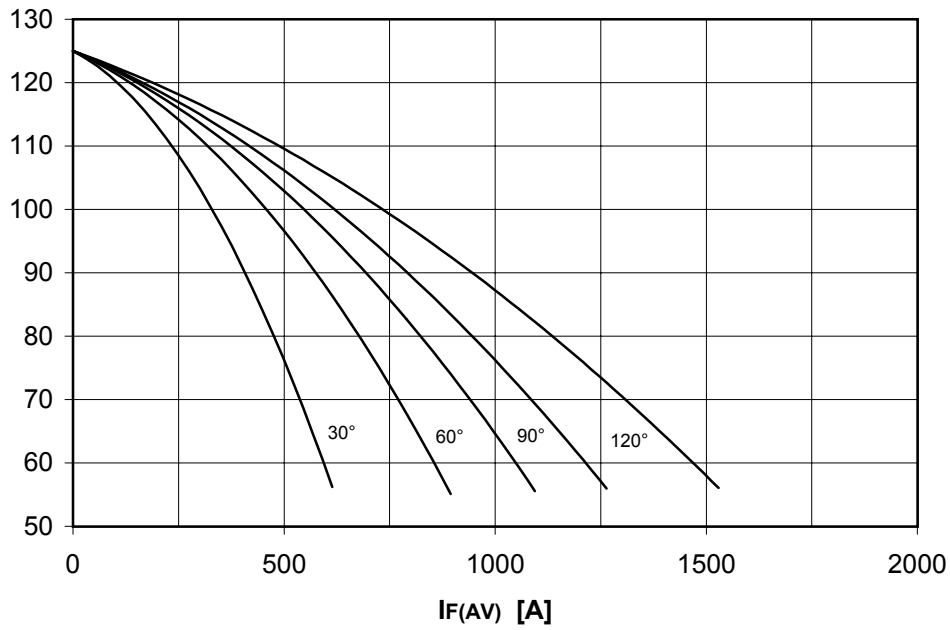

PF(AV) [W]

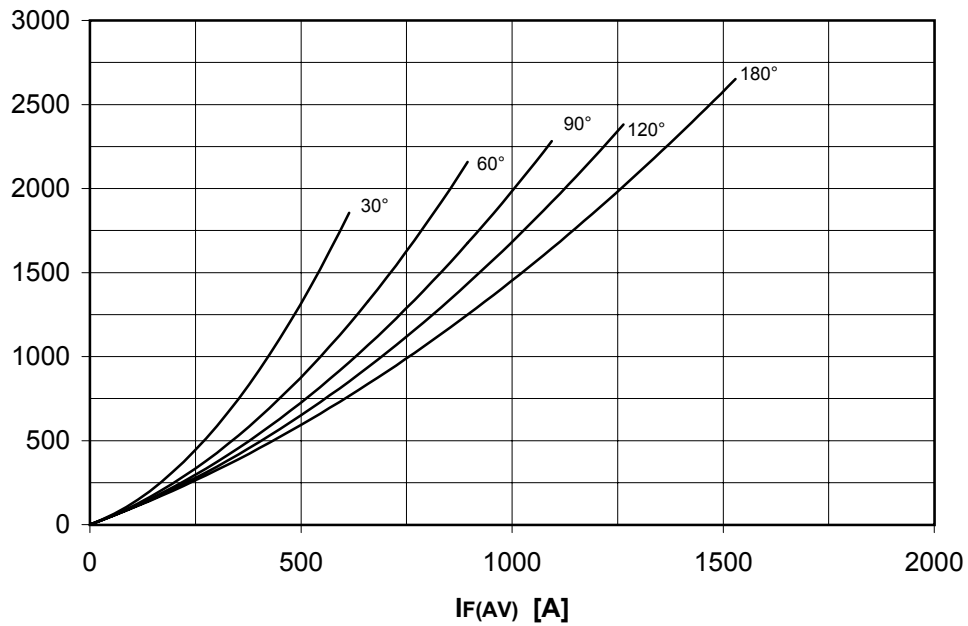

AT1004 PHASE CONTROL THYRISTOR

FINAL SPECIFICATION feb 97 - ISSUE : 06

ON-STATE CHARACTERISTIC
T_j = 125 °C

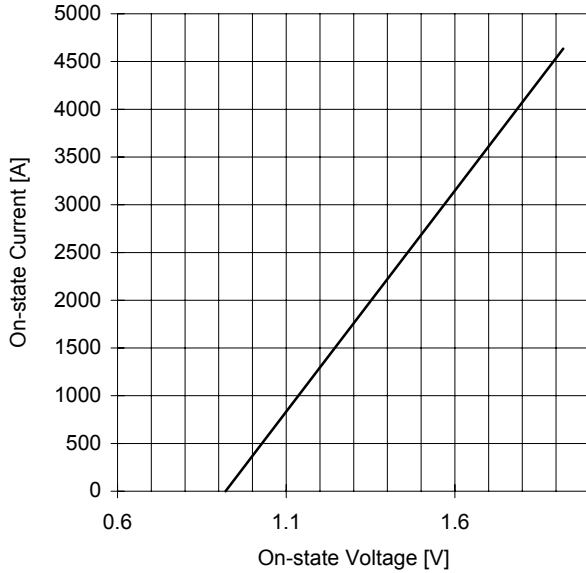

SURGE CHARACTERISTIC
T_j = 125 °C

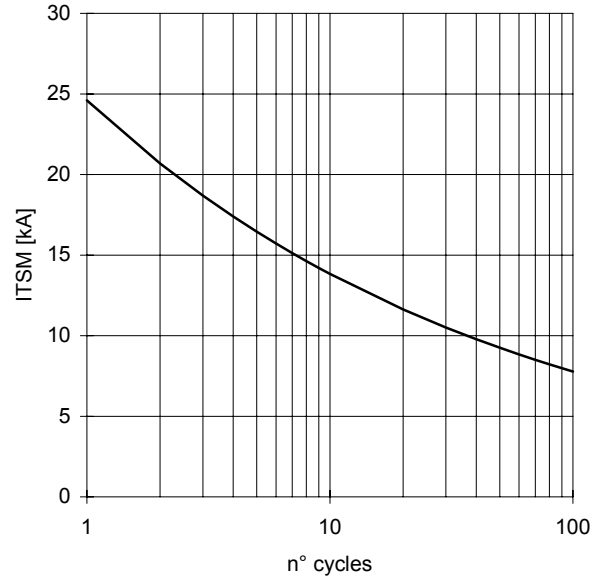

TRANSIENT THERMAL IMPEDANCE
DOUBLE SIDE COOLED

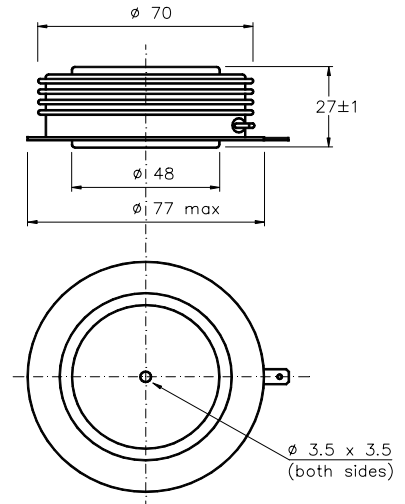
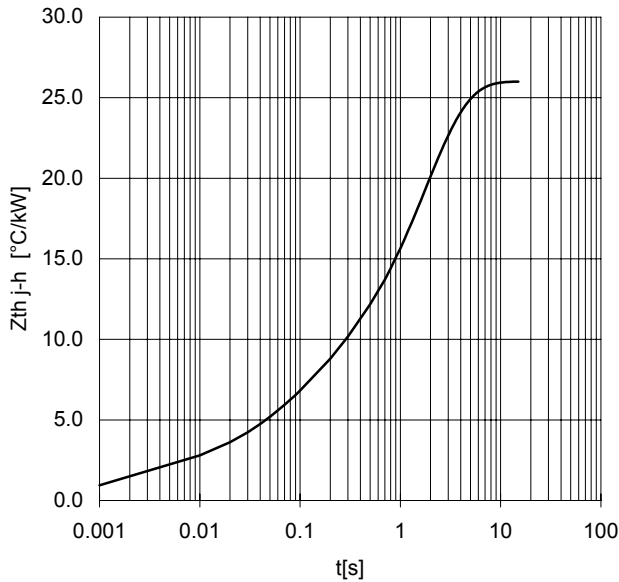

Dimensions
in mm



Cathode terminal type DIN 46244 - A 4.8 - 0.8

Gate terminal type AMP 60598 - 1

All the characteristics given in this data sheet are guaranteed only with uniform clamping force, cleaned and lubricated heatsink, surfaces with flatness < .03 mm and roughness < 2 μm .

In the interest of product improvement POSEICO SPA reserves the right to change any data given in this data sheet at any time without previous notice.

If not stated otherwise the maximum value of ratings (symbols over shaded background) and characteristics is reported.

Distributed by

