**9- to 12-bit Selectable, $\pm 1.0^{\circ}\text{C}$ Accurate
Digital Temperature Sensor**

DATASHEET**Features**

- Single 1.7V to 5.5V Supply
- Measures Temperature From -55°C to $+125^{\circ}\text{C}$
- Highly Accurate Temperature Measurements Requiring No External Components
 - $\pm 1.0^{\circ}\text{C}$ Accuracy (Typical) Over the -20°C to $+100^{\circ}\text{C}$ Range
 - $\pm 1.0^{\circ}\text{C}$ Accuracy (Typical) Over the -10°C to $+100^{\circ}\text{C}$ Range (WLCSP Only)
 - $\pm 2.0^{\circ}\text{C}$ Accuracy (Typical) Over the -40°C to $+125^{\circ}\text{C}$ Range
- User-configurable Resolution
 - 9 to 12 bits (0.5°C to 0.0625°C)
- User-configurable High and Low Temperature Limits
- ALERT Output Pin for Indicating Temperature Alarms
- 2-Wire I²C and SMBus™ Compatible Serial Interface
 - Supports SMBus Timeout
 - Supports SMBus Alert and Alert Response Address (ARA)
 - Selectable Addressing Allows Up to Eight Devices on the Same Bus
- I²C High-Speed (HS) Mode Compatible
 - 3.4MHz Maximum Clock Frequency
- Built-in noise Suppression Filtering for Clock and Data Input Signals
- Low-power Dissipation
 - 85 μA Active Current (Typical) During Temperature Measurements
- Shutdown Mode to Minimize Power Consumption
 - 1 μA Shutdown Current (Typical)
- One-Shot Mode for Single Temperature Measurement While in Shutdown Mode
- Pin and Software Compatible to Industry-standard LM75-type Devices
- Industry Standard Green (Pb/Halide-free/RoHS Compliant) Package Options
 - 8-lead SOIC (150mil)
 - 8-lead MSOP (3.0 x 3.0mm)
 - 8-pad Ultra Thin DFN (UDFN — 2.0 x 3.0 x 0.6mm)
 - 4-ball WLCSP
 - 5-ball WLCSP

Description

The AT30TS74 is a complete, precise temperature monitoring device designed for use in a variety of applications which require the measuring of local temperatures as an integral part of the system's function and/or reliability. The AT30TS74 device combines a high-precision digital temperature sensor, programmable high and low temperature alarms, and a 2-Wire I²C and SMBus (System Management Bus) compatible serial interface into a single compact package.

The temperature sensor can measure temperatures over the full -55°C to +125°C temperature range and has a maximum accuracy of ±2.0°C from -20°C to +100°C. The result of the digitized temperature measurements are stored in one of the AT30TS74 internal registers, which is readable at any time through the device's serial interface.

The AT30TS74 utilizes flexible, user-programmable internal registers to configure the temperature sensor's performance and response to high and low temperature conditions. A dedicated alarm output activates if the temperature measurement exceeds the user-defined temperature and fault count limits. To reduce current consumption and save power, the AT30TS74 features a Shutdown mode which turns off all internal circuitry except for the internal Power-On Reset (POR) and serial interface circuits.

The AT30TS74 is factory-calibrated and requires no external components to measure temperature. With its flexibility and high-degree of accuracy, the AT30TS74 is ideal for extended temperature measurements in a wide variety of communication, computer, consumer, environmental, industrial, and instrumentation applications.

Table of Contents

1. Pin Descriptions and Pinouts	5
2. Block Diagram	6
3. Device Communication	7
3.1 Start Condition	7
3.2 Stop Condition	7
3.3 Acknowledge (ACK)	7
3.4 No-Acknowledge (NACK)	8
4. Device Operation	9
4.1 WLCSP (Wafer Level Chip Scale Package) Device Addressing	9
4.2 High-Speed Mode	10
4.3 Temperature Measurements	11
4.4 Temperature Alarm	11
4.4.1 Fault Tolerance Limits	12
4.4.2 Comparator Mode	12
4.4.3 Interrupt Mode	13
4.5 Shutdown Mode	15
4.5.1 One-Shot Mode	15
5. Registers	16
5.1 Pointer Register	16
5.2 Temperature Register	17
5.3 Configuration Register	20
5.3.1 OS Bit	21
5.3.2 R1:R0 Bits	21
5.3.3 FT1:FT0 Bits	21
5.3.4 POL Bit	22
5.3.5 CMP/INT Bit	22
5.3.6 SD Bit	22
5.4 T _{LOW} and T _{HIGH} Limit Registers	23
6. SMBus Features and I²C General Call	25
6.1 SMBus Alert	25
6.2 SMBus Timeout	26
6.3 General Call	26
7. Electrical Specifications	27
7.1 Absolute Maximum Ratings	27
7.2 DC and AC Operating Range	27
7.3 DC Characteristics	28
7.4 Temperature Sensor Accuracy and Conversion Characteristics	29
7.5 AC Characteristics	29
7.6 Power-Up Conditions	30
7.7 Pin Capacitance	31
7.8 Input Test Waveforms and Measurement Levels	31
7.9 Output Test Load	31

8. Ordering Information	32
8.1 Ordering Code Detail	32
8.2 Green Package Options (Pb/Halide-free/RoHS Compliant)	33
9. Part Marking Detail	34
10. Packaging Information	35
10.1 8S1 — 8-lead JEDEC SOIC	35
10.2 8XM — 8-lead MSOP	36
10.3 8MA2 — 8-pad UDFN	37
10.4 4U-3 — 4-ball WLCSP	38
10.5 5U-5 — 5-ball WLCSP	39
11. Errata	40
11.1 No Errata	40
12. Revision History	41

1. Pin Descriptions and Pinouts

Table 1. Pin Description

Symbol	Name and Function	Asserted State	Type
SCL	<p>Serial Clock: This pin is used to provide a clock to the device and is used to control the flow of data to and from the device. Command and input data present on the SDA pin is always latched in on the rising edge of SCL, while output data on the SDA pin is always clocked out on the falling edge of SCL.</p> <p>The SCL pin must either be forced high when the serial bus is idle or pulled-high using an external pull-up resistor.</p>	—	Input
SDA	<p>Serial Data: The SDA pin is an open-drain bidirectional input/output pin used to serially transfer data to and from the device.</p> <p>The SDA pin must be pulled-high using an external pull-up resistor and may be wire-ANDed with any number of other open-drain or open-collector pins from other devices on the same bus.</p>	—	Input/Output
ALERT	<p>Alert: The ALERT pin is an open-drain output pin used to indicate when the temperature goes beyond the user-programmed temperature limits. The ALERT pin can be operated in one of two different modes (Interrupt or Comparator mode) as defined by the CMP/INT bit in the Configuration Register. The ALERT pin defaults to an active-low output upon device power-up or reset but can be reconfigured as an active-high output by setting the POL bit in the Configuration Register.</p> <p>This pin can be wire-ANDed together with ALERT pins from other devices on the same bus. When wire-ANDing pins together, the ALERT pin should be configured as an active-low output so that when a single ALERT pin on the common alert bus goes active, the entire common alert bus will go low and the host controller will be properly notified since other ALERT pins that may be in the inactive-high state will not mask the true alert signal. In an SMBus environment, the SMBus host can respond by sending an SMBus ARA (Alert Response Address) command to determine which device on the SMBus generated the alert signal.</p> <p>The ALERT pin must be pulled-high using an external pull-up resistor even when it is not used. Care must also be taken to prevent this pin from being shorted directly to ground without a resistor at any time whether during testing or normal operation.</p>	—	Output
A ₂₋₀	<p>Address Inputs: The A₂₋₀ pins are used to select the device address and correspond to the three least-significant bits (LSBs) of the I²C/SMBus 7-bit slave address. These pins can be directly connected in any combination to V_{CC} or GND, and by utilizing the A₂₋₀ pins, up to eight devices may be addressed on a single bus.</p> <p>The A₂₋₀ pins are internally pulled to GND and may be left floating; however, it is highly recommended the A₂₋₀ pins always be directly connected to V_{CC} or GND to ensure a known address state.</p> <p>For the 4-ball WLCSP offering, see Section 4.1 for additional information.</p>	—	Input
V _{CC}	<p>Device Power Supply: The V_{CC} pin is used to supply the source voltage to the device.</p> <p>Operations at invalid V_{CC} voltages may produce spurious results and should not be attempted.</p>	—	Power
GND	<p>Ground: The ground reference for the power supply. GND should be connected to the system ground.</p>	—	Power

Figure 1. Pin Configurations

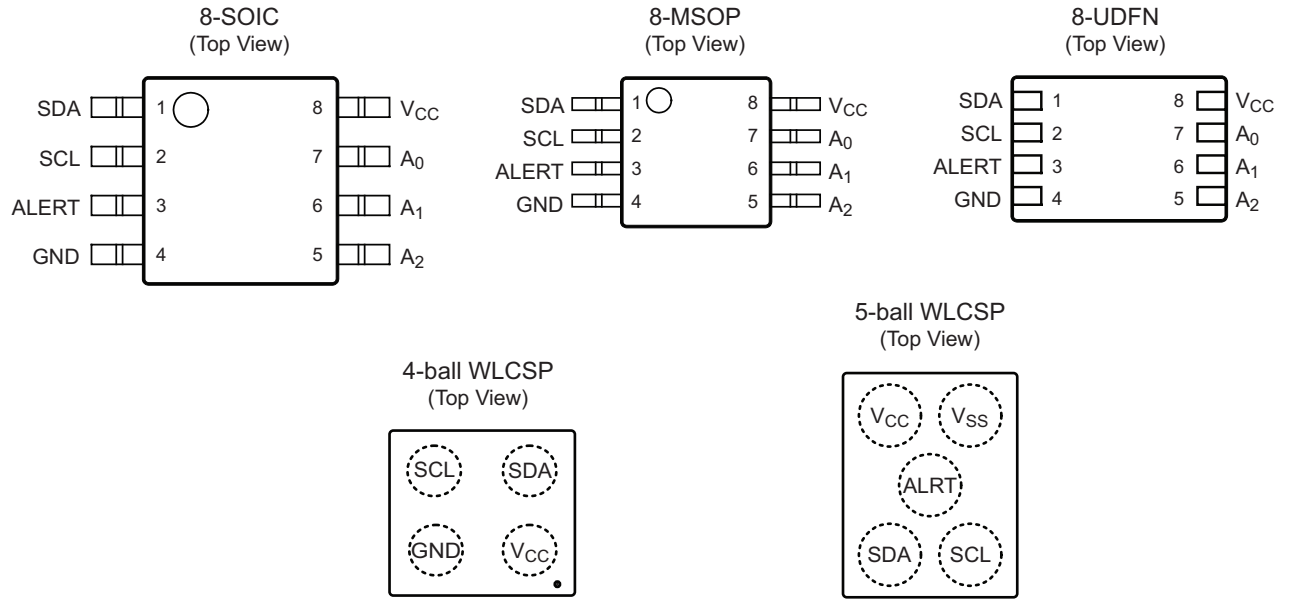

Note: Drawings are not to scale.

2. Block Diagram

Figure 2-1. Block Diagram



3. Device Communication

The AT30TS74 operates as a slave device and utilizes a simple 2-Wire I²C and SMBus compatible digital serial interface to communicate with a host controller, commonly referred to as the bus Master. The Master initiates and controls all Read and Write operations to the slave devices on the serial bus, and both the Master and the slave devices can transmit and receive data on the bus.

The serial interface is comprised of just two signal lines:

- **Serial Clock (SCL):**
The SCL pin is used to receive the clock signal from the Master.
- **Serial Data (SDA):**
The bidirectional SDA pin is used to receive command and data information from the Master as well as to send data back to the Master.

Data is always latched into the AT30TS74 on the rising edge of SCL and always output from the device on the falling edge of SCL. Both the SCL and SDA pin incorporate integrated spike suppression filters and Schmitt Triggers to minimize the effects of input spikes and bus noise.

All command and data information is transferred with the Most-Significant Bit (MSB) first. During bus communication, one data bit is transmitted every clock cycle, and after eight bits (one byte) of data has been transferred, the receiving device must respond with either an Acknowledge (ACK) or a No-acknowledge (NACK) response bit during a ninth clock cycle (ACK/NACK clock cycle) generated by the Master. Therefore, nine clock cycles are required for every one byte of data transferred. There are no unused clock cycles during any Read or Write operation, so there must not be any interruptions or breaks in the data stream during each data byte transfer and ACK or NACK clock cycle.

During data transfers, data on the SDA pin must only change while SCL is low, and the data must remain stable while SCL is high. If data on the SDA pin changes while SCL is high, then either a Start or a Stop condition will occur. Start and Stop conditions are used to initiate and end all serial bus communication between the Master and the slave devices. The number of data bytes transferred between a Start and a Stop condition is not limited and is determined by the Master.

In order for the serial bus to be idle, both the SCL and SDA pins must be in the logic-high state at the same time.

3.1 Start Condition

A Start condition occurs when there is a high-to-low transition on the SDA pin while the SCL pin is stable in the logic-high state. The Master uses a Start condition to initiate any data transfer sequence, and the Start condition must precede any command. The AT30TS74 will continuously monitor the SDA and SCL pins for a Start condition, and the device will not respond unless one is given.

3.2 Stop Condition

A Stop condition occurs when there is a low-to-high transition on the SDA pin while the SCL pin is stable in the logic-high state. The Master uses the Stop condition to end a data transfer sequence to the AT30TS74 which will subsequently return to the idle state. The Master can also utilize a repeated Start condition instead of a Stop condition to end the current data transfer if the Master will perform another operation.

3.3 Acknowledge (ACK)

After every byte of data received, the AT30TS74 must acknowledge to the Master it has successfully received the data byte by responding with an ACK. This is accomplished by the Master first releasing the SDA line and providing the ACK/NACK clock cycle (a ninth clock cycle for every byte). During the ACK/NACK clock cycle, the AT30TS74 must output a Logic 0 (ACK) for the entire clock cycle such that the SDA line must be stable in the logic-low state during the entire high period of the clock cycle.

3.4 No-Acknowledge (NACK)

When the AT30TS74 is transmitting data to the Master, the Master can indicate it is done receiving data and wants to end the operation by sending a NACK response to the AT30TS74 instead of an ACK response. This is accomplished by the Master outputting a Logic 1 during the ACK/NACK clock cycle. At which point, the AT30TS74 will release the SDA line so the Master can then generate a Stop condition.

In addition, the AT30TS74 can use a NACK to respond to the Master instead of an ACK for certain invalid operation cases such as an attempt to write to a Read-only Register (e.g. an attempt to write to the Temperature Register).

Figure 3-1. Start, Stop, and ACK



4. Device Operation

Commands used to configure and control the operation of the AT30TS74 are sent to the device from the Master via the serial interface. Likewise, the Master can read the temperature data from the AT30TS74 via the serial interface. However, since multiple slave devices can reside on the serial bus, each slave device must have its own unique 7-bit address so that the Master can access each device independently.

For the AT30TS74, the first four MSBs of its 7-bit address are the device type identifier and are fixed at 1001. The remaining three LSBs correspond to the states of the hard-wired A_{2-0} address pins. For the WLCSP product offering, see [Section 4.1](#) for additional information on how the device address bits are handled.

Example: If the A_{2-0} pins are connected to GND, then the 7-bit device address would be 1001000.

In order for the Master to select and access the AT30TS74, the Master must first initiate a Start condition. Following the Start condition, the Master must output the device address byte. The device address byte consists of the 7-bit device address plus a Read/Write (R/\overline{W}) control bit, which indicates whether the Master will be performing a Read or a Write to the AT30TS74. If the R/\overline{W} control bit is a Logic 1, then the Master will be reading data from the AT30TS74. Alternatively, if the R/\overline{W} control bit is a Logic 0, then the Master will be writing data to the AT30TS74.

Table 4-1. AT30TS74 Address Byte

Bit 7	Bit 6	Bit 5	Bit 4	Bit 3	Bit 2	Bit 1	Bit 0
Device Type Identifier				Device Address			Read/Write
1	0	0	1	A2	A1	A0	R/\overline{W}

If the 7-bit address sent by the Master matches that of the AT30TS74, then the device will respond with an ACK after it has received the full address byte. If there is an address mismatch, then the AT30TS74 will respond with a NACK and return to the idle state.

4.1 WLCSP (Wafer Level Chip Scale Package) Device Addressing

The AT30TS74 is offered in a space saving WLCSP to minimize PCB (Printed Circuit Board) area requirements. Because of the WLCSP dimensions and to maintain a standard ball size and pitch, only four balls can be placed on the WLCSP; therefore, there are no hard-wired A_{2-0} device address pins (pins 5, 6, and 7) available like in other standard eight pin packages where the user can select the desired hard-wired device address combination.

However, the AT30TS74 WLCSP product is still available with all eight device address combinations via ordering a unique part number where each part number variant is internally configured by Microchip Technology Inc. with a different hard-wired A_{2-0} address as shown in [Table 4-2](#).

Example: If the desired hard-wired A_{2-0} device address is 001, then the correct part number to order is the AT30TS74-UFM11-T and this device will only ACK when the Master initiates a Start condition followed by a device address byte with matching device address bits ($A_2=0$, $A_1=0$, $A_0=1$) plus a Read/Write (R/\overline{W}) control bit. Otherwise, the AT30TS74 WLCSP will respond with a NACK and return to the idle state.

Table 4-2. AT30TS74 WLCSP Device Addresses

Part Number	I ² C Address	Device Type Identifier				A ₂	A ₁	A ₀	R/W
		Bit 7	Bit 6	Bit 5	Bit 4	Bit 3	Bit 2	Bit 1	Bit 0
AT30TS74-UFM10-T-072	1001 000X	1	0	0	1	0	0	0	X
AT30TS74-UFM11-T-072	1001 001X	1	0	0	1	0	0	1	X
AT30TS74-UFM12-T-072	1001 010X	1	0	0	1	0	1	0	X
AT30TS74-UFM13-T-072	1001 011X	1	0	0	1	0	1	1	X
AT30TS74-UFM14-T-072	1001 100X	1	0	0	1	1	0	0	X
AT30TS74-UFM15-T-072	1001 101X	1	0	0	1	1	0	1	X
AT30TS74-UFM16-T-072	1001 110X	1	0	0	1	1	1	0	X
AT30TS74-UFM17-T-072	1001 111X	1	0	0	1	1	1	1	X
AT30TS74-U1FMAB-T	1001 000X	1	0	0	1	0	0	0	X
AT30TS74-U1FMBB-T	1001 001X	1	0	0	1	0	0	1	X
AT30TS74-U1FMCB-T	1001 010X	1	0	0	1	0	1	0	X
AT30TS74-U1FMDB-T	1001 011X	1	0	0	1	0	1	1	X
AT30TS74-U1FMEB-T	1001 100X	1	0	0	1	1	0	0	X
AT30TS74-U1FMFB-T	1001 101X	1	0	0	1	1	0	1	X
AT30TS74-U1FMGB-T	1001 110X	1	0	0	1	1	1	0	X
AT30TS74-U1FMHB-T	1001 111X	1	0	0	1	1	1	1	X

Note: Please contact Microchip Technology Inc. for availability of slave address options 011,100,101,110, and 111.

4.2 High-Speed Mode

The AT30TS74 supports the I²C High-Speed (HS) mode allowing it to operate at clock frequencies up to 3.4MHz. In order to put the AT30TS74 into the HS mode, the Master must first initiate a Start condition followed by the HS mode master code of 00001XXX. Since the HS mode master code is meant to be recognized by all slave devices which support the HS mode, the AT30TS74 will not ACK the HS mode master code. Instead, the Master will output a NACK during the ACK/NACK clock cycle.

Once the AT30TS74 receives the HS mode master code, it will switch its input filters on SDA and SCL to the HS mode to allow transfers up to 3.4MHz. The device will then return to the idle state and wait for a repeated Start condition before the next operation can occur.

To begin the next operation, the Master must issue a repeated Start condition followed by the device address byte. The AT30TS74 will continue to operate in the HS mode until the Master sends a Stop condition; therefore, the Master should use repeated Start conditions to begin new operations rather than a Stop-Start sequence. Once the AT30TS74 receives a Stop condition, the device will switch its input and output filters back to the standard I²C mode.

Figure 4-1. High-Speed Mode



4.3 Temperature Measurements

The AT30TS74 utilizes a band-gap type temperature sensor with an internal sigma-delta Analog-to-Digital Converter (ADC) to measure and convert the temperature reading into a digital value with a selectable resolution as high as 0.0625°C. The measured temperature is calibrated in degrees Celsius; therefore, a lookup table or conversion routine is necessary for applications that wish to deal in degrees Fahrenheit.

The result of the digitized temperature measurements are stored in the internal Temperature Register of the AT30TS74, which is readable at any time through the device's serial interface. When in the normal operating mode, the device performs continuous temperature measurements and updates the contents of the Temperature Register (see [Section 5.2, "Temperature Register"](#)) after each analog-to-digital conversion.

The resolution of the temperature measurement data can be configured to 9, 10, 11, or 12 bits which corresponds to temperature increments of 0.5°C, 0.25°C, 0.125°C, and 0.0625°C, respectively. Selecting the temperature resolution is done using the R1 and R0 bits in the Configuration Register (see [Section 5.3, "Configuration Register"](#)). The ADC conversion time does increase with each bit of higher resolution, so careful consideration should be given to the resolution versus conversion time relationship. The default resolution after device power-up or reset is nine bits, which retains backwards compatibility to industry-standard LM75-type devices.

With 12 bits of resolution, the AT30TS74 can theoretically measure a temperature range of 255°C (-128°C to +127°C); however, the device is only designed to measure temperatures over a range of -55°C to +125°C.

4.4 Temperature Alarm

After the measured temperature value has been stored into the Temperature Register, the data will be compared with both the high and low temperature limits defined by the values stored in the T_{HIGH} Limit Register and T_{LOW} Limit Register. If the comparison results in a valid fault condition (see [Section 4.4.1, "Fault Tolerance Limits"](#)), then the device will activate the ALERT output pin.

The polarity and function of the ALERT pin can be configured by using specific bits in the Configuration Register. The ALERT pin defaults to the active low state after device power-up or reset but can be reconfigured to active high by setting the POL bit in the Configuration Register to a Logic 1. The function of the ALERT pin changes based on the Alarm Thermostat mode, which can be configured to either Comparator mode (see [Section 4.4.2, "Comparator Mode"](#)) or Interrupt mode (see [Section 4.4.3, "Interrupt Mode"](#)) by using the CMP/INT bit in the Configuration Register. The Comparator mode is the default operating mode after the device powers up or resets.

The value of the high temperature limit stored in the T_{HIGH} Limit Register must be greater than the value of the low temperature limit stored in the T_{LOW} Limit Register in order for the ALERT function to work properly; otherwise, the ALERT pin will output erroneous results and will falsely signal temperature alarms.

4.4.1 Fault Tolerance Limits

A temperature fault occurs if the measured temperature meets or exceeds either the high temperature limit set by the T_{HIGH} Limit Register or the low temperature limit set by the T_{LOW} Limit Register. To prevent false alarms due to environmental or temperature noise, the device incorporates a fault tolerance queue that requires consecutive temperature faults to occur before resulting in a valid fault condition. The fault tolerance queue value is controlled by the FT1 and FT0 bits in the Configuration Register and can be set to a single fault count of 1 or a count of 2, 4, or 6 consecutive faults.

An internal counter that automatically increments after a temperature fault is used to determine if the fault tolerance queue setting has been met. After incrementing the fault counter, the device will compare the count to the fault tolerance queue setting to see if a valid fault condition should be triggered. Once a valid fault condition occurs, the device will activate the ALERT output pin. If the most recent measured temperature does not meet or exceed the high or low temperature limit, then the internal fault counter will be reset back to zero.

Figure 4-2 shows a sample temperature profile and how each temperature fault would impact the internal fault counter.

Figure 4-2. Fault Count Example



4.4.2 Comparator Mode

When the device operates in the Comparator mode, then the ALERT pin goes active if the measured temperature meets or exceeds the high temperature limit set by the T_{HIGH} Limit Register and a valid fault condition exists (the consecutive number of temperature faults has been reached). The ALERT pin will return to the inactive state after the measured temperature drops below the T_{LOW} Limit Register value the appropriate number of times to create a subsequent valid fault condition. The ALERT pin only changes state based on the high and low temperature limits and fault conditions; reading from or writing to any register or putting the device into Shutdown mode will not affect the state of the ALERT pin. The high temperature limit set by the T_{HIGH} Limit Register must be greater than the low temperature limit set by the T_{LOW} Limit Register in order for the ALERT pin to activate correctly.

If switching from Interrupt mode to Comparator mode while the ALERT pin is already active, then the ALERT pin will remain active until the measured temperature is below the T_{LOW} Limit Register value the appropriate number of times to create a valid fault condition.

The ALERT pin will return to the inactive state if the device receives the General Call Reset command. In addition, the state of the Configuration Register will return to the power-on default state, and the device will remain in the Comparator mode.

Figure 4-3 illustrates both the active high and active low ALERT pin response for a sample temperature profile with the device configured for the Comparator mode and a fault tolerance queue setting of two.

Figure 4-3. Comparator Mode (Fault Tolerance Queue = 2)



4.4.3 Interrupt Mode

Similar to the Comparator mode, when the device operates in the Interrupt mode, the ALERT pin will go active if the measured temperature meets or exceeds the high temperature limit set by the T_{HIGH} Limit Register and a valid fault condition exists (the consecutive number of temperature faults has been reached). Unlike the Comparator mode, however, the ALERT pin will remain active until one of three normal operation events takes place: any one of the device's registers is read, the device responds to an SMBus Alert Response Address (ARA), or the device is put into Shutdown mode.

Once the ALERT pin returns to the inactive state, it will not go active again until the measured temperature drops below the low temperature limit set by the T_{LOW} Limit Register for the appropriate number of consecutive faults. Again, the ALERT pin will remain active until one of the device's registers is read, the device responds to an SMBus ARA, or the device is placed into the Shutdown mode.

After the ALERT pin becomes inactive again, the cycle will repeat itself with the ALERT pin going active after the measured temperature meets or exceeds the T_{HIGH} Limit Register value for the proper number of consecutive faults. This process is cyclical between T_{HIGH} and T_{LOW} temperature alarms (e.g. T_{HIGH} event, ALERT clear, T_{LOW} event, ALERT clear, T_{HIGH} event, ALERT clear, T_{LOW} event, etc.).

In order for the ALERT pin to normally become active for the first time in the Interrupt Mode, the first event must be a T_{HIGH} temperature alarm event. Therefore, even if the measured temperature initially starts off between the T_{HIGH} and T_{LOW} limits and then drops below the T_{LOW} temperature limit and has met valid fault conditions, the ALERT pin will still not go active. The high temperature limit set by the T_{HIGH} Limit Register must be greater than the low temperature limit set by the T_{LOW} Limit Register in order for the ALERT pin to activate correctly.

If switching from Comparator mode to Interrupt mode while the ALERT pin is already active, then the ALERT pin will remain active until it is cleared by one of the events already detailed: any one of the device's registers is read, the device responds to an SMBus ARA, or the device is put into Shutdown mode. The ALERT pin will also return to the inactive state if the device receives the General Call Reset command. When reset, the state of the Configuration Register will return to the power-on default state which will put the device back into the Comparator mode.

Figures 4-4 and Figure 4-5 show both the active high and active low ALERT pin response for a sample temperature profile with the device configured for the Interrupt mode and a fault tolerance queue setting of two. Figure 4-5 illustrates how the ALERT pin output would look if there was a longer delay between the ALERT trigger and the reading of a register.

Figure 4-4. Interrupt Mode (Fault Tolerance Queue = 2)



Figure 4-5. Interrupt Mode (Fault Tolerance Queue = 2) Delay Before Reading Register

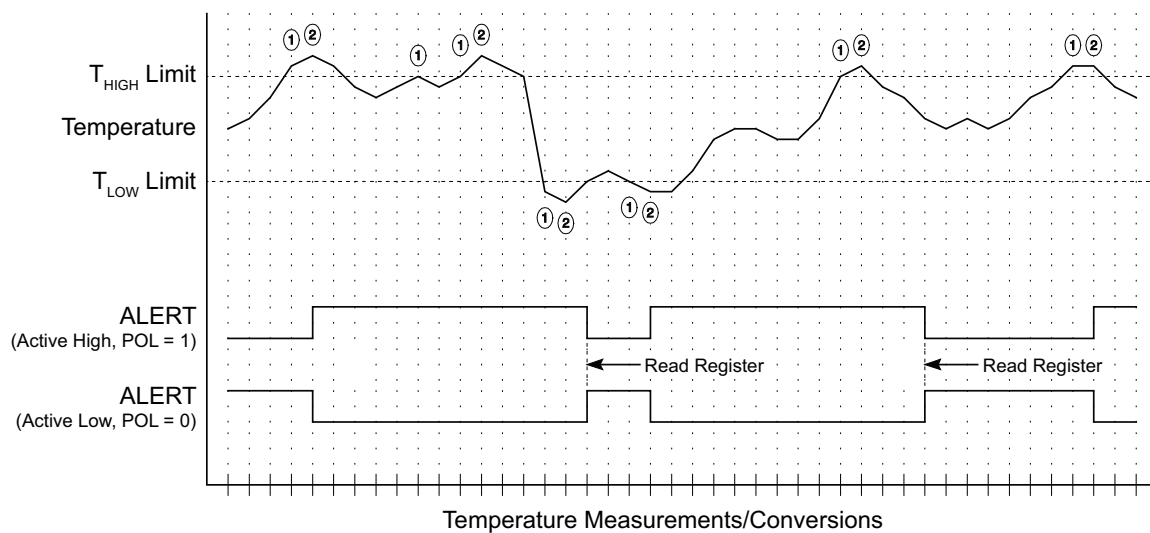

4.5 Shutdown Mode

To reduce current consumption and save power, the device features a Shutdown mode that disables all internal device circuitry except for the serial interface and POR circuits. While in the Shutdown mode, the internal temperature sensor is not active, so no temperature measurements will be made. Entering and exiting the Shutdown mode is controlled by the SD bit in the Configuration Register.

Entering the Shutdown mode can affect the ALERT pin depending on the Alarm Thermostat mode. If the device is configured to operate in the Interrupt mode, then the ALERT pin will go inactive when the device enters the Shutdown mode. However, the ALERT pin will not change states if the device is operating in the Comparator mode.

The fault count information will not change when the device enters or exits the Shutdown mode. Therefore, the number of previous temperature faults recorded by the internal fault counter will be retained unless the device is power-cycled or reset. When exiting the Shutdown mode, the ALERT pin will go active if operating in Interrupt mode, a valid fault condition exists, and the T_{HIGH} and T_{LOW} event cycles are maintained (i.e. T_{HIGH} event before entering Shutdown mode followed by a T_{LOW} event when exiting Shutdown mode).

4.5.1 One-Shot Mode

The AT30TS74 features a One-Shot Temperature mode that allows the device to perform a single temperature measurement while in the Shutdown mode. By keeping the device in the Shutdown mode and utilizing the One-Shot mode, the AT30TS74 can remain in a lower power state and only go active to take temperature measurements on an as-needed basis. The internal fault counter will be updated when taking a temperature measurement using the One-Shot mode; therefore, a valid fault condition can be generated by the One-Shot temperature measurements. If operating in Comparator mode, then the fault condition will cause the ALERT pin to go either active or inactive depending on if the fault condition is a result of a T_{HIGH} or T_{LOW} event. If operating in Interrupt mode, the fault condition will cause the ALERT pin to pulse active for a short duration of time to indicate a T_{HIGH} or T_{LOW} event has occurred. The ALERT pin will then return to the inactive state.

The One-Shot mode is controlled using the OS bit in the Configuration Register (see [Section 5.3.1, "OS Bit"](#)).

5. Registers

The AT30TS74 contains five registers (a Pointer Register and four data registers) that are used to control the operational mode and performance of the temperature sensor, store the user-defined high and low temperature limits, and store the digitized temperature measurements. All accesses to the device are performed using these five registers. In order to read from and write to one of the device's four data registers, the user must first select a desired data register by utilizing the Pointer Register.

Table 5-1. Registers

Register	Address	Read/Write	Size	Power-on Default
Pointer Register	n/a	W	8-bit	00h
Temperature Register	00h	R	16-bit	0000h
Configuration Register	01h	R/W	16-bit	0000h
T _{LOW} Limit Register	02h	R/W	16-bit	4B00h (75°C)
T _{HIGH} Limit Register	03h	R/W	16-bit	5000h (80°C)

The Configuration Register, despite being 16-bits wide, is compatible to industry standard LM75-type temperature sensors that use an 8-bit wide register in that only the first 8-bits of the Configuration Register need to be written to or read from.

5.1 Pointer Register

The 8-bit Write-only Pointer Register is used to address and select which one of the device's four data registers (Temperature Register, Configuration Register, T_{LOW} Limit Register, or T_{HIGH} Limit Register) will be read from or written to.

For Read operations from the AT30TS74, once the Pointer Register is set to point to a particular data register, it remains pointed to that same data register until the Pointer Register value is changed.

Example: If the user sets the Pointer Register to point to the Temperature Register, then all subsequent reads from the device will output data from the Temperature Register until the Pointer Register value is changed.

For Write operations to the AT30TS74, the Pointer Register value must be refreshed each time a Write to the device is to be performed, even if the same data register is going to be written to a second time in a row.

Example: If the Pointer Register is set to point to the Configuration Register, once the subsequent Write operation to the Configuration Register has completed, the user cannot write again into the Configuration Register without first setting the Pointer Register value again. As long as a Write operation is to be performed, the device will assume that the Pointer Register value is the first data byte received after the address byte.

Since only four data registers are available for access, only the two LSBs (P1 and P0) of the Pointer Register are used; the remaining six bits (P7-P2) of the Pointer Register should always be set to zero to allow for future migration paths to other temperature sensor devices that have more than four data registers. [Table 5-2](#) shows the bit assignments of the Pointer Register and the associated pointer addresses of the data registers available. Attempts to write any values other than those listed in [Table 5-2](#) into the Pointer Register will be ignored by the device, and the contents of the Pointer Register will not be changed. However, the device will respond back to the Master with an ACK to indicate that the device successfully received a data byte even though no operation will be performed.

Table 5-2. Pointer Register and Address Assignments

Pointer Register Value								Associated Address	Register Selected
P7	P6	P5	P4	P3	P2	P1	P0		
0	0	0	0	0	0	0	0	00h	Temperature Register
0	0	0	0	0	0	0	1	01h	Configuration Register
0	0	0	0	0	0	1	0	02h	T _{LOW} Limit Register
0	0	0	0	0	0	1	1	03h	T _{HIGH} Limit Register

To set the value of the Pointer Register, the Master must first initiate a Start condition followed by the AT30TS74 device address byte (1001AAA0 where “AAA” corresponds to the hard-wired A₂₋₀ address pins). After the AT30TS74 has received the proper address byte, the device will send an ACK to the Master. The Master must then send the appropriate data byte to the AT30TS74 to set the value of the Pointer Register.

After device power-up or reset, the Pointer Register defaults to 00h which is the Temperature Register location; therefore, the Temperature Register can be read from immediately after device power-up or reset without having to set the Pointer Register.

Figure 5-1. Write Pointer Register



5.2 Temperature Register

The Temperature Register is a 16-bit Read-only Register that stores the digitized value of the most recent temperature measurement. The temperature data value is represented in the two's complement format, and, depending on the resolution selected, up to 12 bits of data will be available for output with the remaining LSBs being fixed in the Logic 0 state. The Temperature Register can be read at any time, and since temperature measurements are performed in the background, reading the Temperature Register does not affect any other operation that may be in progress.

The MSB (bit 15) of the Temperature Register contains the sign bit of the measured temperature value with a zero indicating a positive number and a one indicating a negative number. The remaining MSBs of the Temperature Register contain the temperature value in the two's complement format. [Table 5-3](#) details the Temperature Register format for the different selectable resolutions, and [Table 5-4](#) shows some examples for 12-bit resolution Temperature Register data values and the associated temperature readings.

Table 5-3. Temperature Register Format

Resolution	Upper Byte								Lower Byte							
	Bit 15	Bit 14	Bit 13	Bit 12	Bit 11	Bit 10	Bit 9	Bit 8	Bit 7	Bit 6	Bit 5	Bit 4	Bit 3	Bit 2	Bit 1	Bit 0
12 bits	Sign	TD	TD	TD	TD	TD	TD	TD	TD	TD	TD	TD	0	0	0	0
11 bits	Sign	TD	TD	TD	TD	TD	TD	TD	TD	TD	TD	0	0	0	0	0
10 bits	Sign	TD	TD	TD	TD	TD	TD	TD	TD	TD	0	0	0	0	0	0
9 bits	Sign	TD	TD	TD	TD	TD	TD	TD	TD	0	0	0	0	0	0	0

Note: TD = Temperature Data

Table 5-4. 12-bit Resolution Temperature Data/Values Examples

Temperature	Temperature Register Data	
	Binary Value	Hex Value
+125°C	0111 1101 0000 0000	7D00h
+100°C	0110 0100 0000 0000	6400h
+75°C	0100 1011 0000 0000	4B00h
+50.5°C	0011 0010 1000 0000	3200h
+25.25°C	0001 1001 0100 0000	1940h
+10.125°C	0000 1010 0010 0000	0A20h
+0.0625°C	0000 0000 0001 0000	0010h
0°C	0000 0000 0000 0000	0000h
-0.0625°C	1111 1111 1111 0000	FFF0h
-10.125°C	1111 0101 1110 0000	F5E0h
-25.25°C	1110 0111 1100 0000	E7C0h
-50.5°C	1100 1110 1000 0000	CE80h
-55°C	1100 1001 0000 0000	C900h

After each temperature measurement and digital conversion is complete, the new temperature data is loaded into the Temperature Register if the register is not currently being read. If a Read is in progress, then the previous temperature data will be output.

In order to read the most recent temperature measurement data, the Pointer Register must be set or have been previously set to 00h. If the Pointer Register has already been set to 00h, the Temperature Register can be read by having the Master first initiate a Start condition followed by the AT30TS74 device address byte (1001AAA1 where “AAA” corresponds to the hard-wired A₂₋₀ address pins). After the AT30TS74 has received the proper address byte, the device will send an ACK to the Master. The Master can then read the upper byte of the Temperature Register. After the upper byte of the Temperature Register has been clocked out of the AT30TS74, the Master must send an ACK to indicate that it is ready for the lower byte of the temperature data. The AT30TS74 will then clock out the lower byte of the Temperature Register, after which the Master must send a NACK to end the operation. When the AT30TS74 receives the NACK, it will release the SDA line so that the Master can send a Stop or repeated Start condition. If the Master does not send a NACK but instead sends an ACK after the lower byte of the Temperature Register has been clocked out, then the device will repeat the sequence by outputting new temperature data starting with the upper byte of the Temperature Register.

If 8-bit temperature resolution is satisfactory, then the lower byte of the Temperature Register does not need to be read. In this case, the Master would send a NACK instead of an ACK after the upper byte of the Temperature Register has been clocked out of the AT30TS74. When the AT30TS74 receives the NACK, the device will know that it should not send out the lower byte of the Temperature Register and will instead release the SDA line so the Master can send a Stop or repeated Start condition.

The Temperature Register defaults to 0000h after device power-up or reset; therefore, the system should wait the maximum conversion time (t_{CONV}) for the selected resolution before attempting to read valid temperature data. Since the Temperature Register is a Read-only register, any attempts to write to the register will be ignored, and the device will subsequently respond by sending a NACK back to the Master.

Figure 5-2. Read Temperature Register — 16 Bits



Note: Assumes the Pointer Register was previously set to point to the Temperature Register.

Figure 5-3. Read Temperature Register — 8 Bits

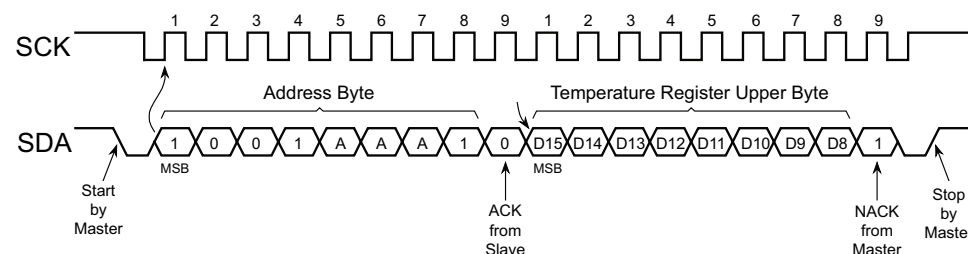

Note: Assumes the Pointer Register was previously set to point to the Temperature Register.

5.3 Configuration Register

The Configuration Register is used to control key operational modes and settings of the device such as the One-Shot mode, the temperature conversion resolution, the fault tolerance queue, the ALERT pin polarity, the Alarm Thermostat mode, and the Shutdown mode. The Configuration Register is a 16-bit wide Read/Write register; however, only the first 8-bits of the register are actually used while the least-significant 8-bits are reserved for future use to provide an upward migration path to other temperature sensor devices that have enhanced features. Since only the most-significant eight bits of the Configuration Register are used, the device is backwards compatible to industry standard LM75-type temperature sensors that use 8-bit wide registers.

After device power-up or reset, the Configuration Register defaults to 0000h; therefore, the system should update the Configuration Register with the desired settings prior to attempting to read the Temperature Register unless the default Configuration Register settings are satisfactory for the application.

Table 5-5. Configuration Register

Bit	Name		Type	Description	
15	OS	One-Shot Mode	R/W	0	Normal Operation (Default)
				1	Perform One-Shot Measurement (Valid in Shutdown Mode Only)
14:13	R1:R0	Conversion Resolution	R/W	00	9-bits (Default)
				01	10-bits
				10	11-bits
				11	12-bits
12:11	FT1:FT0	Fault Tolerance Queue	R/W	00	Alarm after 1 Fault (Default)
				01	Alarm after 2 Consecutive Faults
				10	Alarm after 4 Consecutive Faults
				11	Alarm after 6 Consecutive Faults
10	POL	ALERT Pin Polarity	R/W	0	ALERT pin is Active Low (Default)
				1	ALERT pin is Active High
9	CMP/INT	Alarm Thermostat Mode	R/W	0	Comparator Mode (Default)
				1	Interrupt Mode
8	SD	Shutdown Mode	R/W	0	Temperature Sensor Performing Active Measurements (Default)
				1	Temperature Sensor Disabled and Device In Shutdown Mode
7:0	RFU	Reserved for Future Use	R	0	Reserved for Future Use

To set the value of the Configuration Register, the Master must first initiate a Start condition followed by the AT30TS74's device address byte (1001AAA0 where "AAA" corresponds to the hard-wired A₂₋₀ address pins). After the AT30TS74 has received the proper address byte, the device will send an ACK to the Master. The Master must then send the appropriate Pointer Register byte of 01h to select the Configuration Register. After the Pointer Register byte of 01h has been sent, the AT30TS74 will send another ACK to the Master. After receiving the ACK from the AT30TS74, the Master must then send the appropriate data byte to the AT30TS74

to set the value of the Configuration Register. Only the first data byte sent to the AT30TS74 will be recognized as valid data; any subsequent bytes received by the device will simply be ignored. If the Master does not send a complete byte of Configuration Register data prior to issuing a Stop or repeated Start condition, then the AT30TS74 will ignore the data and the contents of the Configuration Register will be unchanged.

5.3.1 OS Bit

The OS bit is used to enable the One-Shot Temperature Measurement mode. When a Logic 1 is written to the OS bit while the AT30TS74 is in the Shutdown mode, the device will become active and perform a single temperature measurement and conversion. After the Temperature Register has been updated with the measured temperature data, the device will return to the low-power Shutdown mode and clear the OS bit.

Writing a one to the OS bit when the device is not in the Shutdown mode will have no effect. When reading the Configuration Register, the OS bit will always be read as a Logic 0.

5.3.2 R1:R0 Bits

The R1 and R0 bits are used to select the conversion resolution of the internal sigma-delta ADC. Four possible resolutions can be set to maximize for either higher resolution or faster conversion times. The R1 and R0 bits default to the Logic 0 state after device power-up or reset to retain backwards compatibility to industry-standard LM75-type devices.

Table 5-6. Conversion Resolution

R1	R0	Conversion Resolution		Conversion Time
0	0	9 bits	0.5°C	25ms
0	1	10 bits	0.25°C	50ms
1	0	11 bits	0.125°C	100ms
1	1	12 bits	0.0625°C	200ms

5.3.3 FT1:FT0 Bits

The FT1 and FT0 bits are used to set the fault tolerance queue value which defines how many consecutive faults must occur before the ALERT pin will be activated (see [Section 4.4.1, “Fault Tolerance Limits”](#)). The FT1 and FT0 bit settings provide four different fault values as detailed in [Table 5-7](#). After the device powers up or resets, both the FT1 and FT0 bits will default to the Logic 0 state.

Table 5-7. Fault Tolerance Queue

NVFT1	NVFT0	Consecutive Faults Required
0	0	1
0	1	2
1	0	4
1	1	6

5.3.4 POL Bit

The ALERT pin polarity is controlled by the POL bit. When the POL bit is in the Logic 0 state, the ALERT pin will be an active low output (the default setting after device power-up or reset). To configure the ALERT pin as an active high output, the POL bit must be set to the Logic 1 state.

5.3.5 CMP/INT Bit

The CMP/INT bit controls whether the device will operate in the Comparator mode or the Interrupt mode. Setting the CMP/INT bit to the Logic 0 state will put the device into the Comparator mode (default after device power-up or reset). Alternatively, when the CMP/INT bit is set to the Logic 1 state, then the device will operate in the Interrupt mode. The function of the ALERT pin changes based on the CMP/INT bit setting.

5.3.6 SD Bit

The SD bit is used to enable or disable the device's Shutdown mode. When the SD bit is in the Logic 0 state (default after device power-up or reset), the device will be in the normal operational mode and perform continuous temperature measurements and conversions. When the SD bit is set to the Logic 1 state, the device will finish the current temperature measurement and conversion and will store the result in the Temperature Register, after which the device will then enter the Shutdown mode.

Resetting the SD bit back to a Logic 0 will return the device to the normal operating mode.

Figure 5-4. Write to Configuration Register



Figure 5-5. Read from Configuration Register

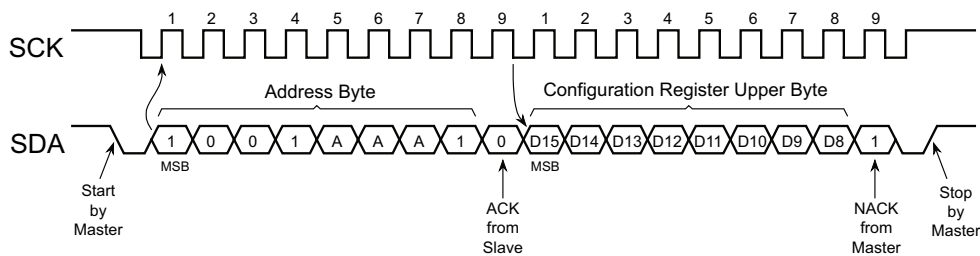

Note: Assumes the Pointer Register was previously set to point to the Configuration Register.

5.4 T_{LOW} and T_{HIGH} Limit Registers

The 16-bit T_{LOW} and T_{HIGH} Limit Registers store the user-programmable lower and upper temperature limits for the temperature alarm. Like the Temperature Register, the temperature data values of the T_{LOW} and T_{HIGH} Limit Registers are stored in the twos complement format with the MSB (bit 15) of the registers containing the sign bit (zero indicates a positive number and a one indicates a negative number).

As with the Temperature Register, the resolution selected by the R1 and R0 bits of the Configuration Register will determine how many bits of the T_{LOW} and T_{HIGH} Limit Registers will be used. Therefore, when writing to the T_{LOW} and T_{HIGH} Limit Registers, up to 12 bits of data will be recognized by the device with the remaining LSBs being internally fixed to the Logic 0 state. Similarly, when reading from the registers, up to 12 bits of data will be output from the device with the remaining LSBs fixed in the Logic 0 state.

Table 5-8. T_{LOW} Limit Register and T_{HIGH} Limit Register Format

Resolution	Upper Byte								Lower Byte							
	Bit 15	Bit 14	Bit 13	Bit 12	Bit 11	Bit 10	Bit 9	Bit 8	Bit 7	Bit 6	Bit 5	Bit 4	Bit 3	Bit 2	Bit 1	Bit 0
12 bits	Sign	TD	TD	TD	TD	TD	TD	TD	TD	TD	TD	TD	0	0	0	0
11 bits	Sign	TD	TD	TD	TD	TD	TD	TD	TD	TD	TD	0	0	0	0	0
10 bits	Sign	TD	TD	TD	TD	TD	TD	TD	TD	TD	0	0	0	0	0	0
9 bits	Sign	TD	TD	TD	TD	TD	TD	TD	TD	0	0	0	0	0	0	0

Note: TD = Temperature Data

To set the value of either the T_{LOW} or T_{HIGH} Limit Register, the Master must first initiate a Start condition followed by the AT30TS74 device address byte (1001AAA0 where “AAA” corresponds to the hard-wired A₂₋₀ address pins). After the AT30TS74 has received the proper address byte, the device will send an ACK to the Master. The Master must then send the appropriate Pointer Register byte of 02h to select the T_{LOW} Limit Register or 03h to select the T_{HIGH} Limit Register. After the Pointer Register byte has been sent, the AT30TS74 will send another ACK to the Master. After receiving the ACK from the AT30TS74, the Master must then send two data bytes to the AT30TS74 to set the value of the T_{LOW} or T_{HIGH} Limit Register. Any subsequent bytes sent to the AT30TS74 will simply be ignored by the device. If the Master does not send two complete bytes of data prior to issuing a Stop or repeated Start condition, then the AT30TS74 will ignore the data and the contents of the register will not be changed.

In order to read the T_{LOW} or T_{HIGH} Limit Register, the Pointer Register must be set or have been previously set to 02h to select the T_{LOW} Limit Register or 03h to select the T_{HIGH} Limit Register (if the previous operation was a Write to one of the registers, then the Pointer Register will already be set for that particular limit register). If the Pointer Register has already been set appropriately, the T_{LOW} or T_{HIGH} Limit Register can be read by having the Master first initiate a Start condition followed by the AT30TS74 device address byte (1001AAA1 where “AAA” corresponds to the hard-wired A₂₋₀ address pins). After the AT30TS74 has received the proper address byte, the device will send an ACK to the Master. The Master can then read the upper byte of the T_{LOW} or T_{HIGH} Limit Register. After the upper byte of the register has been clocked out of the AT30TS74, the Master must send an ACK to indicate that it is ready for the lower byte of data. The AT30TS74 will then clock out the lower byte of the register, after which the Master must send a NACK to end the operation. When the AT30TS74 receives the NACK, it will release the SDA line so that the Master can send a Stop or repeated Start condition. If the Master does not send a NACK but instead sends an ACK after the lower byte of the register has been clocked out, then the device will repeat the sequence by outputting the data again starting with the upper byte of the register.

The T_{LOW} Limit Register defaults to 4B00h (+75°C) and the T_{HIGH} Limit Register defaults to 5000h (+80°C) after the device powers up or resets; therefore, both registers will need to be modified after power-up/reset if these default temperature limits are not satisfactory for the application. The value of the high temperature limit stored in the T_{HIGH} Limit Register must be greater than the value of the low temperature limit stored in the T_{LOW} Limit Register in order for the ALERT function to work properly; otherwise, the ALERT pin will output erroneous results and will falsely signal temperature alarms. In addition, changing either value of the T_{HIGH} or T_{LOW} Limit Register will cause the internal fault counter to reset back to zero.

Figure 5-6. Write to T_{LOW} or T_{HIGH} Limit Register



Figure 5-7. Read from T_{LOW} or T_{HIGH} Limit Register

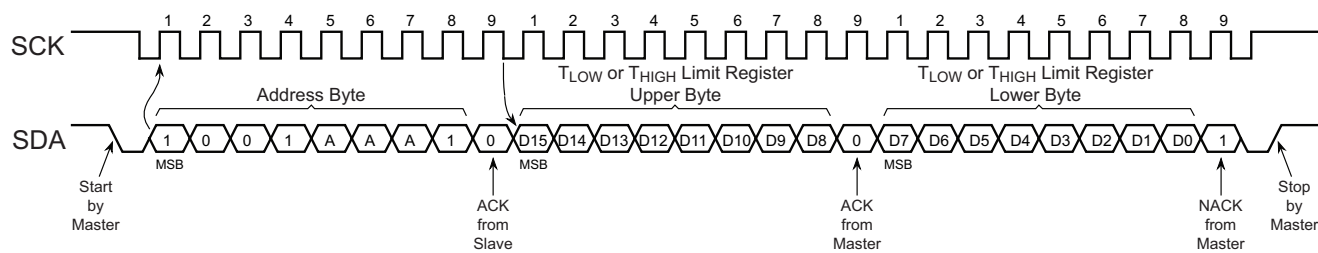

Note: Assumes the Pointer Register was previously set to point to the T_{LOW} or T_{HIGH} Limit Register.

6. SMBus Features and I²C General Call

6.1 SMBus Alert

The AT30TS74 utilizes the ALERT pin to support the SMBus Alert function when the Alarm Thermostat mode is set to the Interrupt mode (the CMP/INT bit of the Configuration Register is set to one) and the ALERT pin polarity is set to active low (the POL bit of the Configuration Register is set to zero). The AT30TS74 is a slave-only device, and normally, slave devices on the SMBus cannot signal to the Master that they want to communicate. However, the AT30TS74 uses the SMBus Alert function (the ALERT pin) to signal to the Master that it wants to communicate.

Several SMBus Alert pins from different slave devices can be connected to a common SMBus Alert input on the Master. When the SMBus Alert input on the Master is pulled low by one of the slave devices, the Master can perform a specialized Read operation from the slave devices to determine which device sent the SMBus Alert signal.

The specialized Read operation is known as an SMBus ARA and requires that the Master first initiate a Start condition followed by the SMBus ARA code of 00011001. The slave device that generated the SMBus Alert signal will respond to the Master with an ACK. After sending the ACK, the slave device will then output its own device address (1001AAA for the AT30TS74 where “AAA” corresponds to the hard-wired A₂₋₀ address pins) on the bus. Since the device address is seven bits long, the remaining eighth bit (the LSB) is used as an indicator to notify the Master which temperature limit caused the alarm (the LSB will be a Logic 1 if the T_{HIGH} limit was met or exceeded, and the LSB will be a Logic 0 if the T_{LOW} limit was exceeded).

The SMBus ARA can activate several slave devices at the same time; therefore, if more than one slave responds, standard SMBus arbitration rules apply and the device with the lowest address wins the arbitration. The device winning the arbitration will clear its SMBus Alert output after it has responded to the SMBus ARA and provided its device address. All other devices with higher addresses do not generate an ACK and continue to hold their SMBus Alert outputs low until cleared. The Master will continue to issue SMBus ARA sequences until all slave devices which generated an SMBus Alert signal have responded and cleared their SMBus Alert outputs.

Figure 6-1. SMBus Alert



Note: The Limit bit (the LSB) of the device address byte will be one or zero depending on if the T_{HIGH} or T_{LOW} limit was exceeded.

6.2 SMBus Timeout

The AT30TS74 supports the SMBus Timeout feature in which the AT30TS74 will reset its serial interface and release the SMBus (stop driving the bus and let SDA float high) if the SCL pin is held low for more than the minimum t_{TIMEOUT} specification. The AT30TS74 will be ready to accept a new Start condition before t_{TIMEOUT} maximum has elapsed.

Figure 6-2. SMBus Timeout



6.3 General Call

The AT30TS74 will respond to an I²C general call address (0000000) from the Master only if the eighth bit (the LSB) of the general call address byte is zero. If the general call address byte is 00000000, then the device will send an ACK to the Master and await a command byte from the Master.

If the Master sends a command byte of 04h, then the AT30TS74 will re-latch the status of its address pins in case the system has assigned a new address to the device. If the Master sends a command byte of 06h (General Call Reset), then the AT30TS74 will re-latch the status of its address pins and perform a reset sequence. The reset sequence will reset all registers to their power-up defaults, and the device will be busy for a maximum time of t_{POR} during the Reset operation.

7. Electrical Specifications

7.1 Absolute Maximum Ratings*

Temperature under Bias	-40°C to +125°C
Storage Temperature	-65°C to +150°C
Supply voltage with respect to ground	-0.5V to +7.0V
ALERT Pin	-0.5V to $V_{CC} + 0.3V$
All input voltages with respect to ground	-0.5V to $V_{CC} + 0.5V$
All other output voltages with respect to ground	-0.5V to $V_{CC} + 0.5V$

*Notice: Stresses beyond those listed under “Absolute Maximum Ratings” may cause permanent damage to the device. Functional operation of the device at these ratings or any other conditions beyond those indicated in the operational sections of this specification is not implied. Exposure to absolute maximum rating conditions for extended periods may affect device reliability. Voltage extremes referenced in the “Absolute Maximum Ratings” are intended to accommodate short duration undershoot/overshoot conditions and does not imply or guarantee functional device operation at these levels for any extended period of time.

Pull-up voltages applied to the ALERT pin that exceed the “Absolute Maximum Ratings” may forward bias to the ESD protection circuitry. Doing so may result in improper device function and may corrupt temperature measurements.

7.2 DC and AC Operating Range

		AT30TS74
Operating Temperature (Case)	Industrial High Temperature	-55°C to +125°C ⁽¹⁾⁽²⁾
V_{CC} Power Supply		1.7V to 5.5V

- Notes: 1. Device operation is guaranteed from -40°C to +125°C.
 2. Device operation is not guaranteed at -55°C but ensured by characterization.

7.3 DC Characteristics

Symbol	Parameter	V _{CC} Range	Condition	Min	Typ ⁽¹⁾	Max	Units
I _{CC1}	Active Current, Bus Inactive	1.7V ≤ V _{CC} ≤ 2.0V	Active Temperature Conversions		60	85	μA
		2.7V ≤ V _{CC} ≤ 3.6V			65	95	
		4.5V ≤ V _{CC} ≤ 5.5V			85	125	
I _{CC2}	Active Current, Bus Active	1.7V ≤ V _{CC} ≤ 2.0V	Active Temperature Conversions, f _{SCL} = 400kHz		120	160	μA
		2.7V ≤ V _{CC} ≤ 3.6V			150	225	
		4.5V ≤ V _{CC} ≤ 5.5V			225	325	
I _{CC3}	Active Current, Bus Active	2.2V ≤ V _{CC} ≤ 3.6V	Active Temperature Conversions, f _{SCL} = 3.4MHz		235	500	μA
		4.5V ≤ V _{CC} ≤ 5.5V			610	800	
I _{SD1}	Shutdown Mode Current, Bus Inactive	1.7V ≤ V _{CC} ≤ 2.0V			0.4	2.5	μA
		2.7V ≤ V _{CC} ≤ 3.6V			0.6	3.5	
		4.5V ≤ V _{CC} ≤ 5.5V			1.2	5.5	
I _{SD2}	Shutdown Mode Current, Bus Active	1.7V ≤ V _{CC} ≤ 2.0V	f _{SCL} = 400kHz		110	160	μA
		2.7V ≤ V _{CC} ≤ 3.6V			130	200	
		4.5V ≤ V _{CC} ≤ 5.5V			180	280	
I _{SD3}	Shutdown Mode Current, Bus Active	2.2V ≤ V _{CC} ≤ 3.6V	f _{SCL} = 3.4MHz		210	425	μA
		4.5V ≤ V _{CC} ≤ 5.5V			550	750	
I _{LI}	Input Leakage Current		V _{IN} = CMOS levels			±1	μA
I _{LO}	Output Leakage Current		V _{OUT} = CMOS levels			±1	μA
V _{IL}	Input Low Voltage					0.3 × V _{CC}	V
V _{IH}	Input High Voltage			0.7 × V _{CC}			V
V _{OL1}	Output Low Voltage		I _{OL} = 3mA			0.4	V
V _{OL2}	Output Low Voltage, ALERT Pin		I _{OL} = 4mA			0.4	V

Note: 1. Typical values characterized at T_A = +25°C at V_{CC} = 1.8V, 3.0V and 5.0V unless otherwise noted.

7.4 Temperature Sensor Accuracy and Conversion Characteristics

Symbol	Parameter	Condition	Min	Typ ⁽¹⁾	Max	Units
T _{ACC}	Sensor Accuracy	T _A = -20°C to +100°C		±1.0	±2.0	°C
		T _A = -10°C to +100°C, WLCSP		±1.0	±2.0	
		T _A = -40°C to +125°C		±2.0	±3.0	
		T _A = -55°C to +125°C ⁽²⁾		±3.0		
T _{RES}	Conversion Resolution	Selectable 9 to 12 bits	0.5 (9 bits)		0.0625 (12 bits)	°C
t _{CONV}	Conversion Time	9-bit Resolution		25	37.5	ms
		10-bit Resolution		50	75	
		11-bit Resolution		100	150	
		12-bit Resolution		200	300	

- Notes: 1. Typical values characterized at V_{CC} = 3.3V, T_A = +25°C unless otherwise noted.
 2. Sensor accuracy characterized to this range but not tested or guaranteed.

7.5 AC Characteristics

Symbol	Parameter	V _{CC} = 1.7V to 3.6V		V _{CC} < 2.2V		V _{CC} = 2.2V to 3.6V		Units
		Fast Mode		Fast Mode Plus		High-Speed Mode		
		Min	Max	Min	Max	Min	Max	
f _{SCL}	Serial Clock Frequency	1 ⁽²⁾	400	1 ⁽²⁾	1000	1 ⁽²⁾	3400	kHz
t _{SCLH}	Clock High Time	600		260		60		ns
t _{SCLL}	Clock Low Time	1300		500		160		ns
t _R	Clock/Data Input Rise Time ⁽¹⁾		300		120		100	ns
t _F	Clock/Data Input Fall Time ⁽¹⁾		300		120		100	ns
t _{SUDAT}	Data In Setup Time	100		50		10		ns
t _{HDDAT}	Data In Hold Time	0		0		0		ns
t _V	Output Valid Time		900		350		80	ns
t _{OH}	Output Hold Time	0		0		0		ns
t _{BUF}	Bus Free Time Between Stop and Start Condition	1300		500		160		ns
t _{SUSTA}	Repeated Start Condition Setup Time (SCL High to SDA Low)	100		50		50		ns
t _{HDSTA}	Start Condition Hold Time (SDA Low to SCL Low)	100		50		50		ns
t _{SUSTO}	Stop Condition Setup Time (SCL High to SDA High)	600		50		50		ns
t _{NS}	Noise Suppression Input Filter Time		100		50		10	ns
t _{TIMEOUT}	SMBus Timeout Time	25	75	25	75	25	75	ms
C _{LOAD}	Capacitive Load for SCL and SDA Lines ⁽¹⁾		400		400		100	pF

- Notes: 1. These parameters are determined through product characterization and are not tested 100% in production.
 2. Minimum clock frequency must be at least 1KHz to avoid activating the SMBus timeout feature.

Figure 7-1. SMBus/I²C Timing Diagram



7.6 Power-Up Conditions

Symbol	Parameter	Min	Max	Units
t_{POR}	Power-On Reset Time		1	ms
V_{POR}	Power-On Reset Voltage Range		1.6	V

Figure 7-2. Power-Up Timing



7.7 Pin Capacitance

Symbol	Parameter	Min	Max	Units
CI/O ⁽¹⁾	Input/Output Capacitance (SDA and ALERT pins)	$V_{I/O} = 0V$	8	pF
CIN ⁽¹⁾	Input Capacitance (A ₂₋₀ and SCL pins)	$V_{IN} = 0V$	6	pF

Note: 1. Not 100% tested (value guaranteed by design and characterization).

7.8 Input Test Waveforms and Measurement Levels



7.9 Output Test Load



8. Ordering Information

8.1 Ordering Code Detail

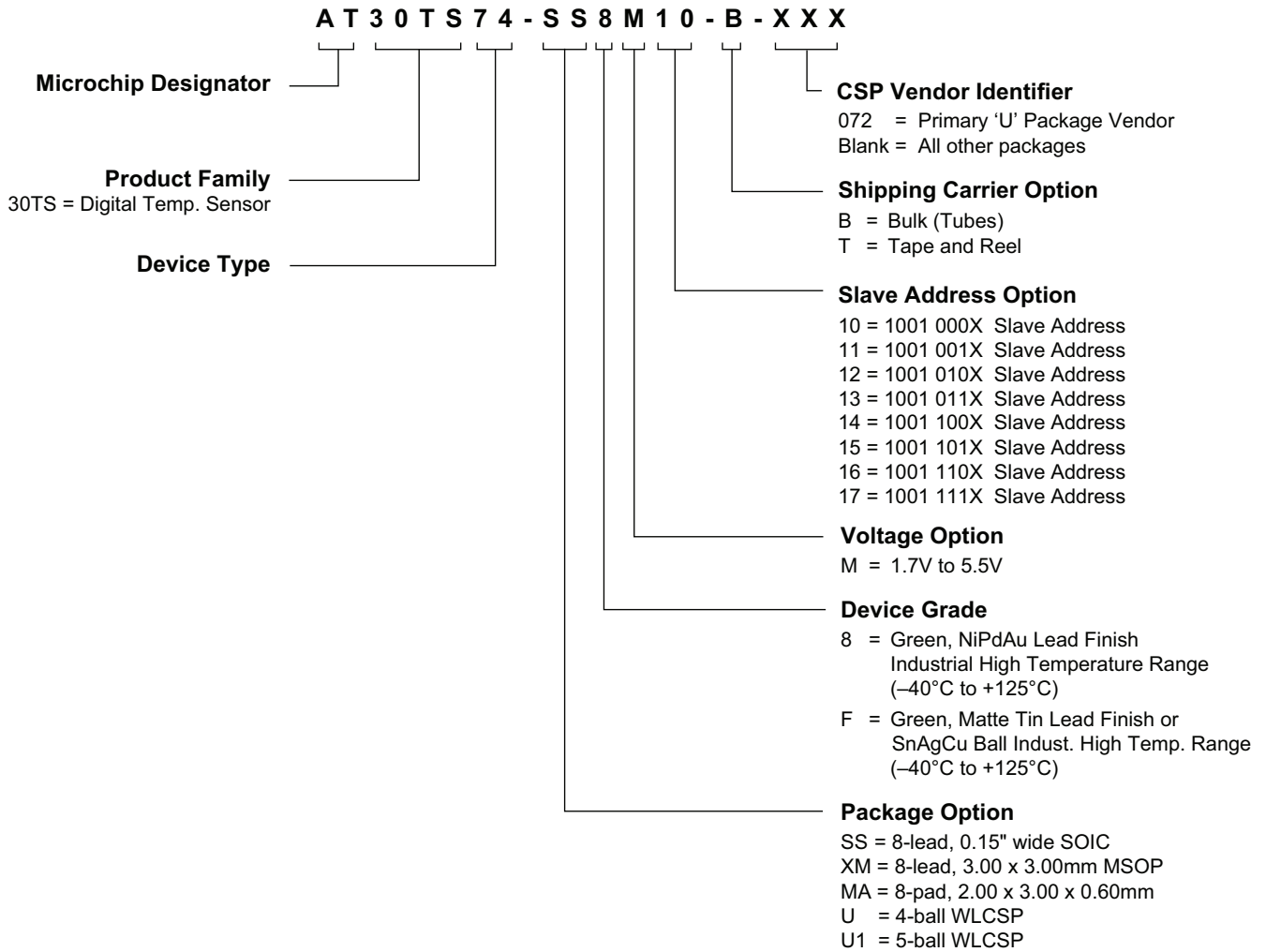

8.2 Green Package Options (Pb/Halide-free/RoHS Compliant)

Ordering Code ⁽¹⁾	Package	Lead Finish	I ² C Address	Operating Voltage	Max. Freq. (kHz)	Operation Range
AT30TS74-SS8M-B	8S1	NiPdAu		1.7V to 5.5V	3400	Industrial High Temperature (-55°C to +125°C)
AT30TS74-SS8M-T						
AT30TS74-XM8M-B	8XM					
AT30TS74-XM8M-T						
AT30TS74-MA8M-T	8MA2					
AT30TS74-UFM10-T-072	4U-3					
AT30TS74-UFM11-T-072		1001 001X				
AT30TS74-UFM12-T-072		1001 010X				
AT30TS74-UFM13-T-072 ⁽²⁾		1001 011X				
AT30TS74-UFM14-T-072 ⁽²⁾		1001 100X				
AT30TS74-UFM15-T-072 ⁽²⁾		1001 101X				
AT30TS74-UFM16-T-072 ⁽²⁾		1001 110X				
AT30TS74-UFM17-T-072 ⁽²⁾		1001 111X				
AT30TS74-U1FMAB-T	5U-5	1001 000X				
AT30TS74-U1FMBB-T		1001 001X				
AT30TS74-U1FMCB-T		1001 010X				
AT30TS74-U1FMDB-T ⁽²⁾		1001 011X				
AT30TS74-U1FMEB-T ⁽²⁾		1001 100X				
AT30TS74-U1FMFB-T ⁽²⁾		1001 101X				
AT30TS74-U1FMGB-T ⁽²⁾		1001 110X				
AT30TS74-U1FMHB-T ⁽²⁾		1001 111X				

- Notes: 1. The shipping carrier option code is not marked on the devices.
 2. Please contact Microchip Technology Inc. for availability of slave address options 011,100,101, 110, and 111.

Package Type	
8S1	8-lead, 0.15" wide, Plastic Gull Wing Small Outline (JEDEC SOIC)
8XM	8-lead, 3.00mm x 3.00mm, Plastic Miniature Small Outline (MSOP)
8MA2	8-pad, 2.00mm x 3.00mm x 0.60mm, Thermally Enhanced Plastic Ultra Thin Dual Flat No Lead (UDFN)
4U-3	4-ball, 2 x 2 Grid Array, Wafer Level Chip Scale (WLCSP)
5U-5	5-ball, 3x3 Array, 0.40mm pitch, Wafer Level Chip Scale Package (WLCSP)

9. Part Marking Detail

AT30TS74: Package Marking Information

8-lead SOIC	8-lead MSOP
	
8-lead UDFN	4-ball/5-ball WLCSP
2.0 x 3.0 mm Body 	

Note 1: ● designates pin 1

Note 2: Package drawings are not to scale

Catalog Number Truncation				
AT30TS74		Truncation Code ###: T9		
Date Codes				Slave Address
Y = Year	M = Month	WW = Work Week of Assembly		% = Slave Address
4: 2014 8: 2018	A: January	02: Week 2		A: Address 000 E: Address 100
5: 2015 9: 2019	B: February	04: Week 4		B: Address 001 F: Address 101
6: 2016 0: 2020		C: Address 010 G: Address 110
7: 2017 1: 2021	L: December	52: Week 52		D: Address 011 H: Address 111
Country of Assembly		Lot Number		Grade/Lead Finish Material
@ = Country of Assembly		AAA...A = Atmel Wafer Lot Number		8: Industrial (C) (-40°C to 125°C)/NiPdAu
Voltage & = Voltage				
M: 1.7V min				
Trace Code				Atmel Truncation
XX = Trace Code (Atmel Lot Numbers Correspond to Code) Example: AA, AB.... YZ, ZZ				AT: Atmel ATM: Atmel ATML: Atmel

1/26/16

 Package Mark Contact: DL-CSO-Assy_eng@atmel.com	TITLE AT30TS74SM, AT30TS74 Package Marking Information	DRAWING NO. 30TS74SM	REV. D
---	---	--------------------------------	------------------

10. Packaging Information

10.1 8S1 — 8-lead JEDEC SOIC



10.2 8XM — 8-lead MSOP

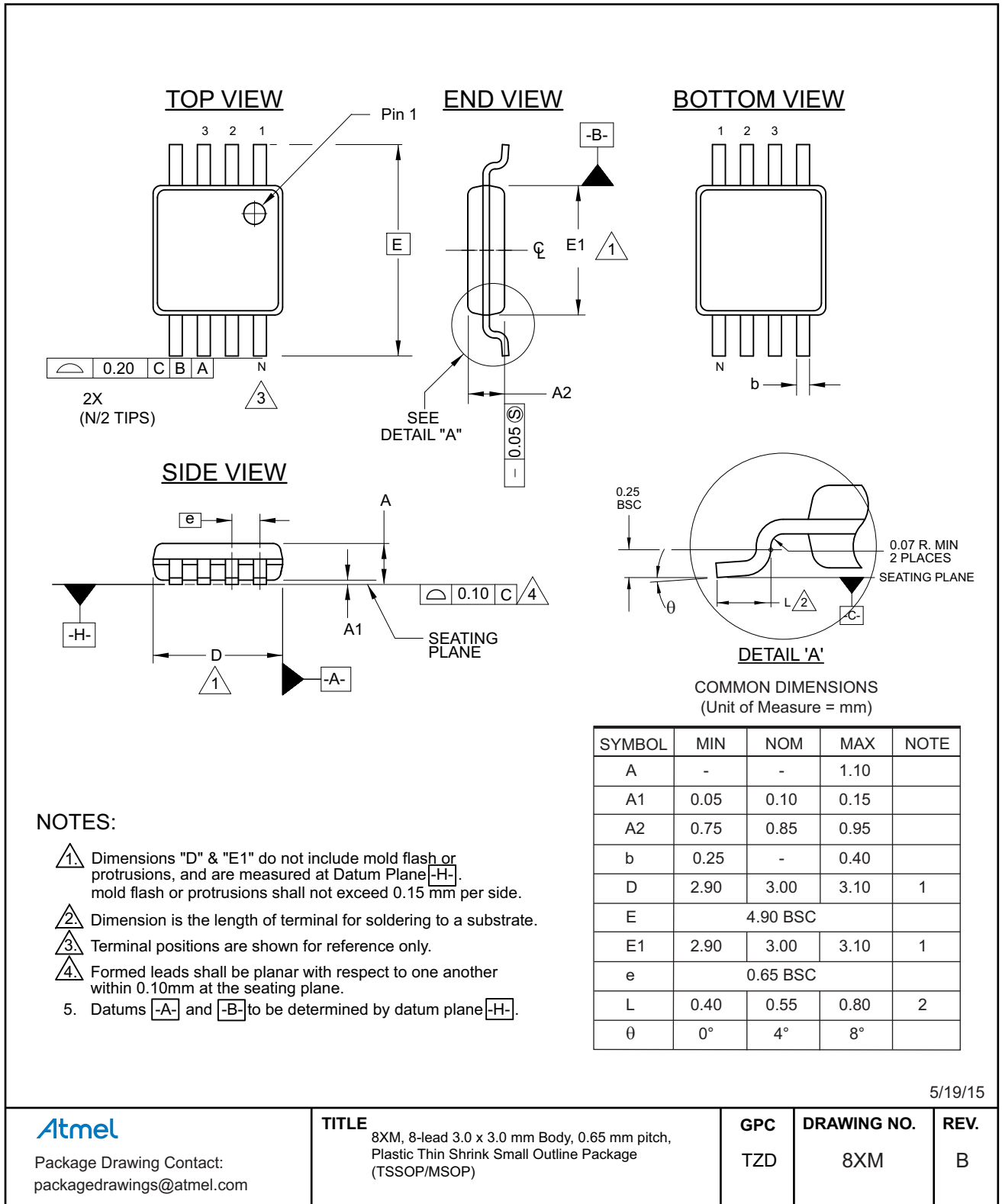

10.3 8MA2 — 8-pad UDFN

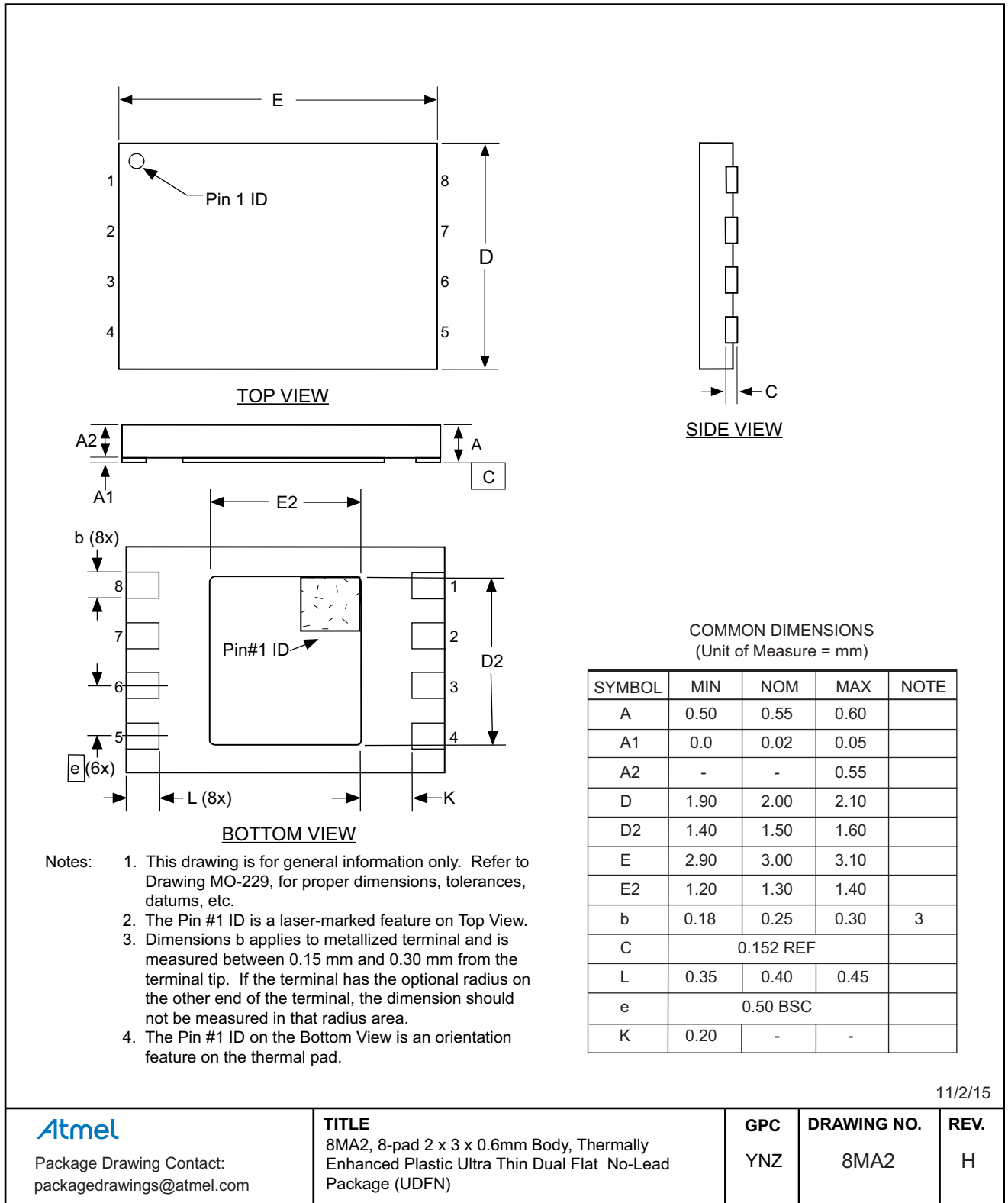

11/2/15

Atmel

Package Drawing Contact:
packagedrawings@atmel.com

TITLE

8MA2, 8-pad 2 x 3 x 0.6mm Body, Thermally Enhanced Plastic Ultra Thin Dual Flat No-Lead Package (UDFN)

GPC

YNZ

DRAWING NO.

8MA2

REV.

H

10.4 4U-3 — 4-ball WLCSP

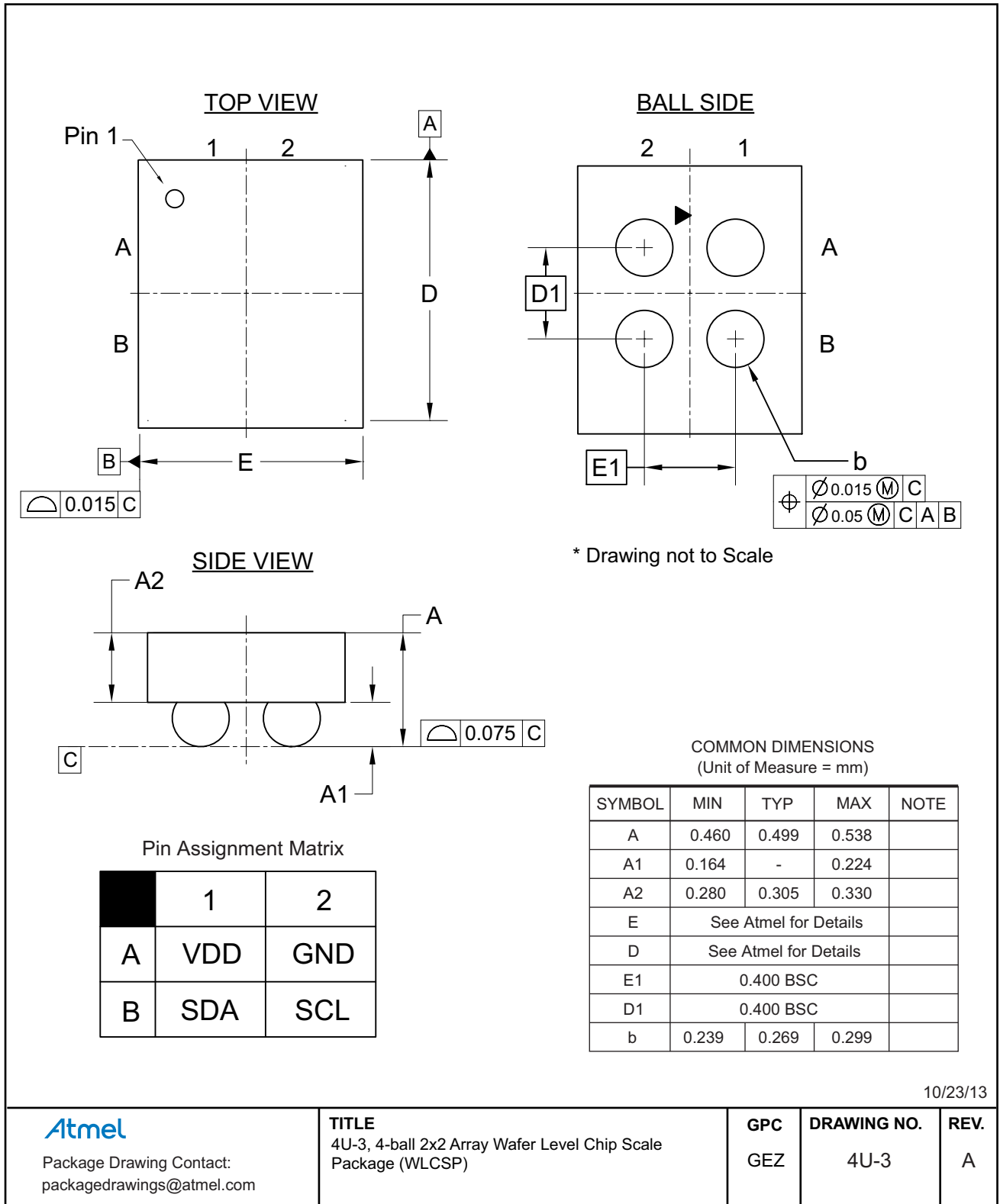

10.5 5U-5 — 5-ball WLCSP



11. Errata

11.1 No Errata

12. Revision History

Doc. Rev.	Date	Comments
8897G	02/2017	Updated the Green Package Options Table
8897F	01/2016	Add 5U-5 5-ball WLCSP package options and update 8MA2 package drawing.
8897E	09/2015	Remove preliminary status. Update 8S1, 8XM, and 8MA2 package drawings.
8897D	10/2014	Update the DC Characteristics and the AC Characteristics tables.
8897C	09/2014	Update Power-up table and figure, and 8MA2 package drawing.
8897B	06/2014	Update part markings and disclaimer page.
8897A	02/2014	Initial document release.



Atmel Corporation 1600 Technology Drive, San Jose, CA 95110 USA T: (+1)(408) 441.0311 F: (+1)(408) 436.4200 | www.atmel.com

© 2016 Atmel Corporation. / Rev.: Atmel-Advance Information-DTS-AT30TS74-Datasheet_022017.

Atmel®, Atmel logo and combinations thereof, Enabling Unlimited Possibilities®, and others are registered trademarks or trademarks of Atmel Corporation in U.S. and other countries. Other terms and product names may be trademarks of others.

DISCLAIMER: The information in this document is provided in connection with Atmel products. No license, express or implied, by estoppel or otherwise, to any intellectual property right is granted by this document or in connection with the sale of Atmel products. EXCEPT AS SET FORTH IN THE ATMEL TERMS AND CONDITIONS OF SALES LOCATED ON THE ATMEL WEBSITE, ATMEL ASSUMES NO LIABILITY WHATSOEVER AND DISCLAIMS ANY EXPRESS, IMPLIED OR STATUTORY WARRANTY RELATING TO ITS PRODUCTS INCLUDING, BUT NOT LIMITED TO, THE IMPLIED WARRANTY OF MERCHANTABILITY, FITNESS FOR A PARTICULAR PURPOSE, OR NON-INFRINGEMENT. IN NO EVENT SHALL ATMEL BE LIABLE FOR ANY DIRECT, INDIRECT, CONSEQUENTIAL, PUNITIVE, SPECIAL OR INCIDENTAL DAMAGES (INCLUDING, WITHOUT LIMITATION, DAMAGES FOR LOSS AND PROFITS, BUSINESS INTERRUPTION, OR LOSS OF INFORMATION) ARISING OUT OF THE USE OR INABILITY TO USE THIS DOCUMENT, EVEN IF ATMEL HAS BEEN ADVISED OF THE POSSIBILITY OF SUCH DAMAGES. Atmel makes no representations or warranties with respect to the accuracy or completeness of the contents of this document and reserves the right to make changes to specifications and products descriptions at any time without notice. Atmel does not make any commitment to update the information contained herein. Unless specifically provided otherwise, Atmel products are not suitable for, and shall not be used in, automotive applications. Atmel products are not intended, authorized, or warranted for use as components in applications intended to support or sustain life.

SAFETY-CRITICAL, MILITARY, AND AUTOMOTIVE APPLICATIONS DISCLAIMER: Atmel products are not designed for and will not be used in connection with any applications where the failure of such products would reasonably be expected to result in significant personal injury or death ("Safety-Critical Applications") without an Atmel officer's specific written consent. Safety-Critical Applications include, without limitation, life support devices and systems, equipment or systems for the operation of nuclear facilities and weapons systems. Atmel products are not designed nor intended for use in military or aerospace applications or environments unless specifically designated by Atmel as military-grade. Atmel products are not designed nor intended for use in automotive applications unless specifically designated by Atmel as automotive-grade.