

FEATURES

- Single +5 Volt Supply
- TO Package Compatible
- Automatic Gain Control
- -38 dBm Sensitivity
- 0 dBm Overload
- 175 MHz Bandwidth

APPLICATIONS

- SONET OC-3/SDH STM-1 (155 Mb/s) Receiver
- FDDI, Ethernet Fiber LAN
- Low Noise RF Amplifier

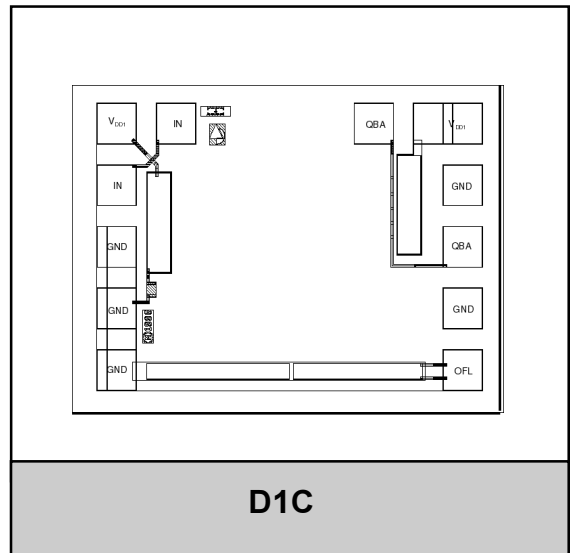

PRODUCT DESCRIPTION

The ANADIGICS ATA01504 is a 5V low noise transimpedance amplifier with AGC designed to be used in OC-3/STM-1 fiber optic links. The device is used in conjunction with a photodetector (PIN diode or avalanche photodiode) to convert an optical signal

into an output voltage. The ATA01504 offers a bandwidth of 175MHz, a dynamic range of 38dB and an alternate pad layout as compared to the ATA01501. It is manufactured in a GaAs MESFET process and is available in bare die form.

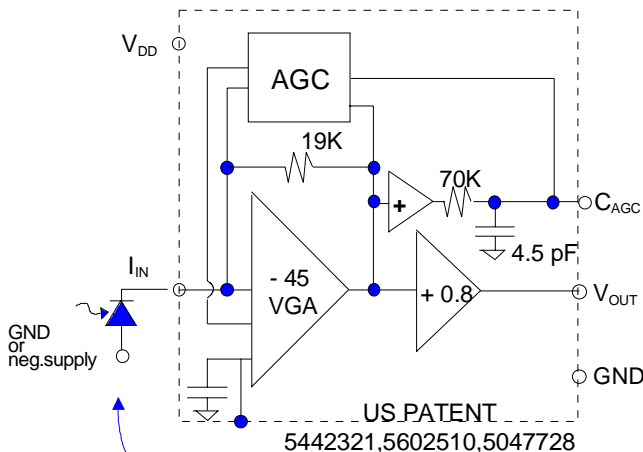

Photodiode cathode must be connected to I_{IN} for proper AGC operation

Figure 1: Equivalent Circuit

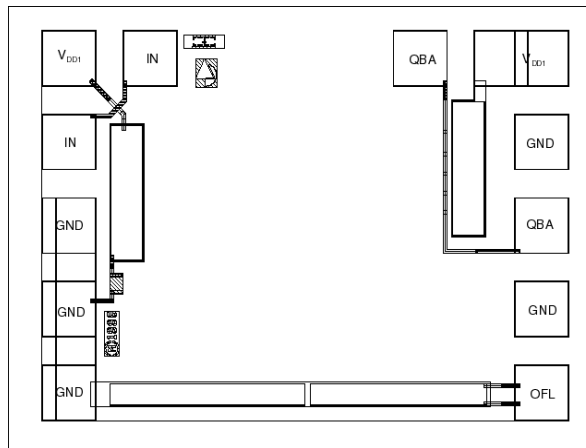

Figure 2: Bonding Pad Layout

Table 1: Pad Description

| PAD | Description | Comment |
|-----------|------------------------|---|
| V_{DD} | V_{DD} | Positive supply for input gain stage |
| I_{IN} | TIA Input Current | Connect detector cathode for proper operation |
| V_{OUT} | TIA Output Voltage | Requires external DC block |
| C_{AGC} | External AGC Capacitor | $70K * (C_{AGC} * 4.5 \text{ pF}) = \text{AGC Time Constant}$ |

ELECTRICAL CHARACTERISTICS

Table 2: Absolute Maximum Ratings

| | |
|----------|-----------------------------------|
| V_{DD} | 7.0 V |
| I_{IN} | 5 mA |
| T_A | Operating Temp. - 40 °C to 125 °C |
| T_S | Storage Temp. - 65 °C to 150 °C |

Stresses in excess of the absolute ratings may cause permanent damage. Functional operation is not implied under these conditions. Exposure to absolute ratings for extended periods of time may adversely affect reliability.

Table 3: Electrical Specifications ⁽¹⁾

($T_A = 25^\circ\text{C}$, $V_{DD} = +5.0\text{V} \pm 10\%$, $C_{\text{DIODE}} + C_{\text{STRAY}} = 0.5 \text{ pF}$, Det. cathode to I_{IN})

| PARAMETER | MIN | TYP | MAX | UNIT |
|---|-------|-------|-------|----------------------|
| Transresistance ($R_L = \infty, I_{DC} < 500\text{nA}$) | | 17 | | $\text{K}\Omega$ |
| Transresistance ($R_L = 50\Omega$) ⁽¹⁾ | 5.5 | 8 | 10 | $\text{K}\Omega$ |
| Bandwidth -3dB | 150 | 175 | | MHz |
| Input Resistance ⁽²⁾ | | 500 | | Ω |
| Output Resistance | 30 | 50 | 60 | Ω |
| Supply Current | | 30 | 45 | mA |
| Input Offset Voltage | 1.5 | 1.6 | 1.9 | Volts |
| Output Offset Voltage | | 1.8 | | Volts |
| AGC Threshold (I_{IN}) ⁽³⁾ | 15 | 30 | | μA |
| Optical Overload ⁽⁴⁾ | -3 | 0 | | dBm |
| Input Noise Current ⁽⁵⁾ | | 14 | 20 | nA |
| AGC Time Constant ⁽⁶⁾ | | 16 | | μsec |
| Offset Voltage Drift | | 1 | | mV/ $^\circ\text{C}$ |
| Optical Sensitivity ⁽⁷⁾ | | -38 | | dBm |
| Operating Voltage Range | + 4.5 | + 5.0 | + 6.0 | Volts |
| Operating Temperature Range | - 40 | | 85 | $^\circ\text{C}$ |

Notes:

1. $f = 50\text{MHz}$
2. Measured with I_{IN} below AGC Threshold. During AGC, input impedance will decrease proportionally to I_{IN} .
3. Defined as the I_{IN} where Transresistance has decreased by 50%.
4. See note on "Indirect Measurement of Optical Overload."
5. See note on "Measurement of Input Referred Noise Current."
6. $C_{AGC} = 220 \text{ pF}$
7. Parameter is guaranteed (not tested) by design and characterization data @155 Mb/s, assuming detector responsivity of 0.9.

APPLICATION INFORMATION

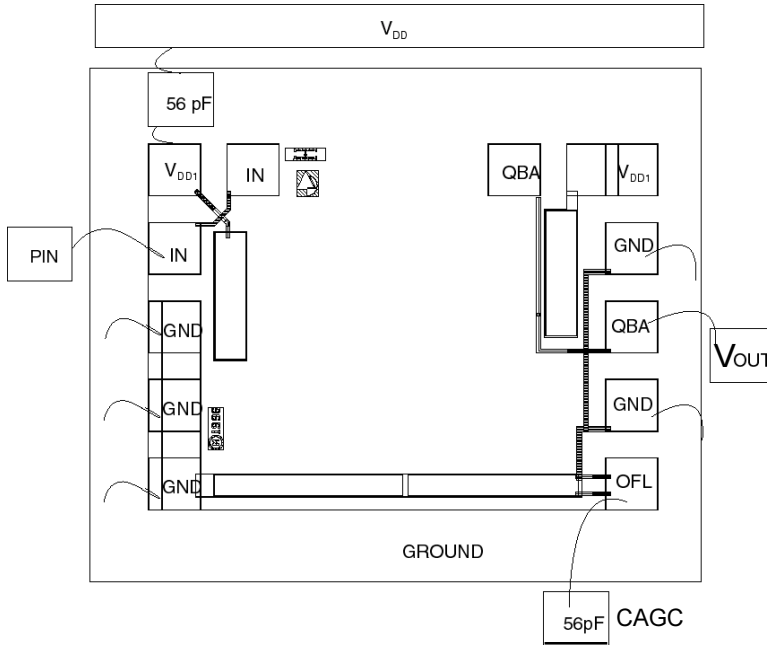

Figure 3: ATA 01504D1C Typical Bonding Diagram

Power supplies and general layout considerations

The ATA01504D1C may be operated from a positive supply as low as +4.5 V and as high as +6.0 V. Below +4.5 V, bandwidth, overload and sensitivity will degrade, while at +6.0 V, bandwidth, overload and sensitivity. Use of surface mount (preferably MIM type capacitors), low inductance power supply bypass capacitors ($\geq 56\text{pF}$) are essential for good high frequency and low noise performance. The power supply bypass capacitors should be mounted on or connected to a good low inductance ground plane.

General layout considerations

Since the gain stages of the transimpedance amplifier have an open loop bandwidth in excess of 1.0 GHz, it is essential to maintain good high frequency layout practices. To prevent oscillations, a low inductance RF ground plane should be made available for power supply bypassing. Traces that can be made short should be made short, and the utmost care should be taken to maintain very low capacitance at the photodiode TIA interface (I_{IN}), as excess capacitance at this node will cause a degradation in bandwidth and sensitivity (see Bandwidth vs. C_T curves).

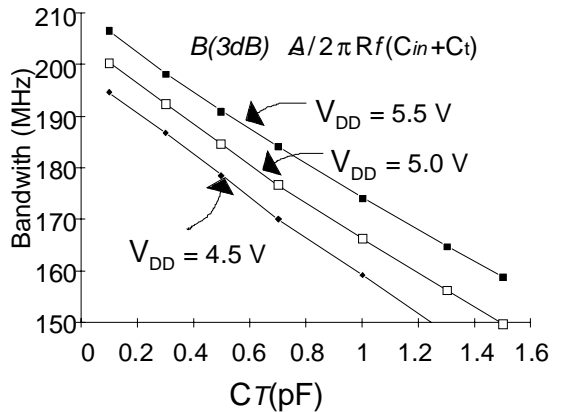

Figure 4: Bandwidth vs. C_T

Note: All performance curves are typical @ $T_A = 25^\circ\text{C}$ unless otherwise noted.

I_{IN} connection

(refer to the equivalent circuit diagram) Bonding the detector cathode to I_{IN} (and thus drawing current from the ATA01504) improves the dynamic range. Although the detector may be used in the reverse direction for input currents not exceeding 25 μA, the specifications for optical overload will not be met.

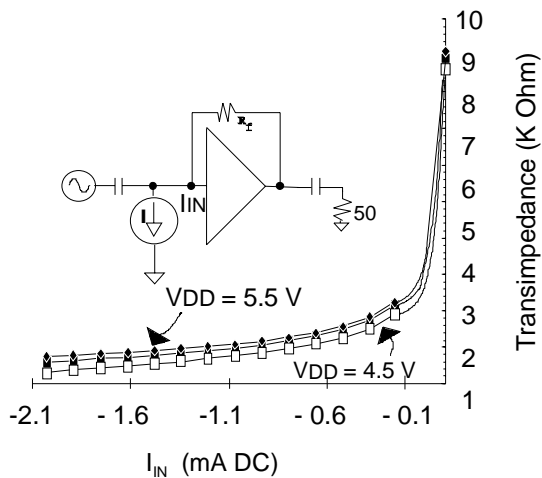

Figure 5: Transimpedance vs. I_{IN}

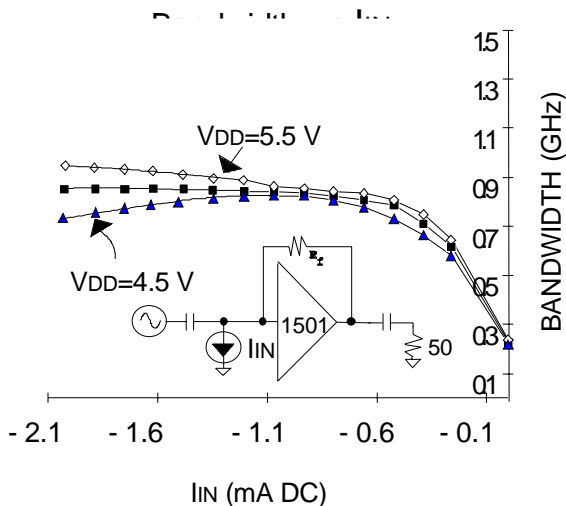

Figure 6: Bandwidth vs. I_{IN}

V_{OUT} Connection

The output pad should be connected via a coupling capacitor to the next stage of the receiver channel (filter or decision circuits), as the output buffers are not designed to drive a DC coupled 50 ohm load (this would require an output bias current of approximately 36 mA to maintain a quiescent 1.8 Volts across the output load). If V_{OUT} is connected to a high input impedance decision circuit (>500 ohms), then a coupling capacitor may not be required, although caution should be exercised since DC offsets of the photo detector/TIA combination may cause clipping of subsequent gain or decision circuits.

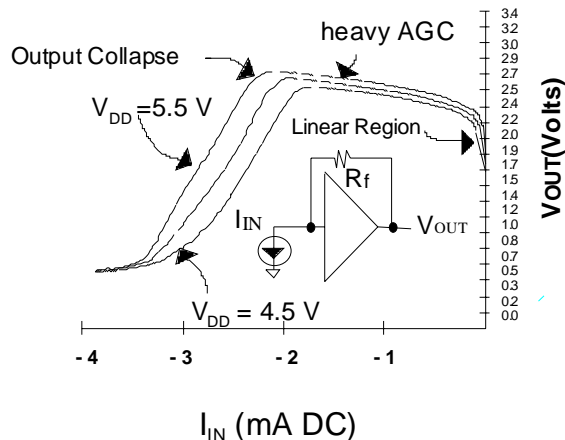

Figure 7: V_{OUT} vs. I_{IN}

Sensitivity and Bandwidth

In order to guarantee sensitivity and bandwidth performance, the TIA is subjected to a comprehensive series of tests at the die sort level (100% testing at 25 °C) to verify the DC parametric performance and the high frequency performance (i.e. adequate |S₂₁|) of the amplifier. Acceptably high |S₂₁| of the internal gain stages will ensure low amplifier input capacitance and hence low input referred noise current. Transimpedance sensitivity and bandwidth are then guaranteed by design and correlation with RF and DC die sort test results.

Indirect Measurement of Optical Overload

Optical overload can be defined as the maximum optical power above which the BER (bit error rate) increases beyond 1 error in 10^{10} bits. The ATA01504D1C is 100% tested at die sort by a DC measurement which has excellent correlation with an PRBS optical overload measurement. The measurement consists of sinking a negative current (see V_{OUT} Vs I_{IN} figure) from the TIA and determining the point of output voltage collapse. Also the input node virtual ground during "heavy AGC" is checked to verify that the linearity (i.e. pulse width distortion) of the amplifier has not been compromised.

Measurement of Input Referred Noise Current

The "Input Noise Current" is directly related to sensitivity. It can be defined as the output noise voltage (V_{out}), with no input signal, (including a 110 MHz lowpass filter at the output of the TIA) divided by the AC transresistance.

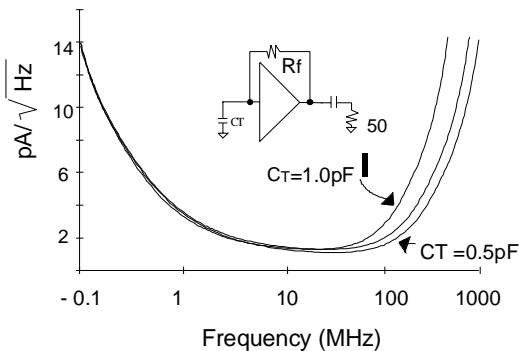

Figure 8: Input Referred Noise Spectral Density

AGC Capacitor

It is important to select an external AGC capacitor of high quality and appropriate size. The ATA01504D1C has an on-chip 70 KW resistor with a shunt 4 pF capacitor to ground. Without external capacitance the chip will provide an AGC time constant of 280 nS. For the best performance in a typical 155 MB/s SONET receiver, a minimum AGC capacitor of 56pF is recommended. This will provide the minimum amount of protection against pattern sensitivity and pulse width distortion on repetitive data sequences during high average optical power conditions. Conservative design practices should be followed when selecting an AGC capacitor, since unit to unit variability of the internal time constant and various data conditions can lead to data errors if the chosen value is too small.

Phase response

At frequencies below the 3dB bandwidth of the device, the transimpedance phase response is characteristic of a single pole transfer function (as shown in the Phase Vs Frequency curve). The output impedance is essentially resistive up to 1000 MHz.

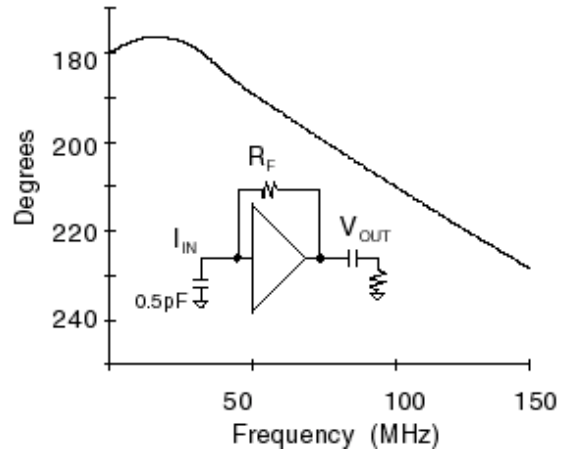

Figure 9: Phase (I_{in} to V_{out})

NOTES

ORDERING INFORMATION

| PART NUMBER | PACKAGE OPTION | PACKAGE DESCRIPTION |
|-------------|----------------|---------------------|
| ATA01504D1C | D1C | Die |

ANADIGICS, Inc.
141 Mount Bethel Road
Warren, New Jersey 07059, U.S.A
Tel: +1 (908) 668-5000
Fax: +1 (908) 668-5132
<http://www.anadigics.com>
Mktg@anadigics.com

IMPORTANT NOTICE

ANADIGICS, Inc. reserves the right to make changes to its products or to discontinue any product at any time without notice. The product specifications contained in Advanced Product Information sheets and Preliminary Data Sheets are subject to change prior to a product's formal introduction. Information in Data Sheets have been carefully checked and are assumed to be reliable; however, ANADIGICS assumes no responsibilities for inaccuracies. ANADIGICS strongly urges customers to verify that the information they are using is current before placing orders.

WARNING

ANADIGICS products are not intended for use in life support appliances, devices, or systems. Use of an ANADIGICS product in any such application without written consent is prohibited.