

## Features

- Supply Voltage up to 40V
- Operating Voltage  $V_S = 5V$  to 18V
- Slew Rate Control according to LIN Specification 2.0
- Supply Current during Sleep Mode Typically 10  $\mu A$
- Supply Current in Silent Mode Typically 40  $\mu A$
- Linear Low-drop Voltage Regulator:
  - Normal Mode:  $V_{CC} = 5V \pm 2\%/50$  mA
  - Silent Mode:  $V_{CC} = 5V \pm 7\%/50$  mA
  - Sleep Mode:  $V_{CC}$  is Switched Off
- $V_{CC}$  Undervoltage Detection (10 ms Reset time) and Watchdog Reset Logically Combined at Output NRES
- Possibility of Boosting the Voltage Regulator with an External NPN Transistor
- LIN Physical Layer according to LIN Specification 2.0
- Wake-up Capability via LIN Bus or WAKE Pin
- Wake-up Recognition
- TXD Time-out Timer
- Debug Mode Watchdog Is Switched Off
- 60V Load Dump Protection at LIN Pin
- Bus Pin is Overtemperature and Short Circuit Protected versus GND and Battery
- Adjustable Watchdog Time via External Resistor
- Positive and Negative Trigger Input for Watchdog
- 5V CMOS Compatible I/O Pins to MCU
- Analog Temperature Monitor Output
- High EMC and ESD Level
- Package: QFN 5 × 5 with 20 Pins

## 1. Description

The ATA6621 is a fully integrated LIN transceiver, complying with the LIN specification, and with a low-drop voltage regulator for 5V/50 mA output and a window watchdog adjustable via an external resistor. In this QFN20 package, the voltage regulator is able to source 50 mA at  $V_S = 18V$  even at an ambient temperature of 105°C. The output current of the regulator can be boosted by using an external NPN transistor. This combination makes it possible to develop simple, but powerful and cheap, slave nodes in LIN bus systems. ATA6621 is designed to handle the low speed data communication in vehicles, for example, in convenience electronics. Improved slope control at the LIN driver ensures secure data communication up to 20 kBaud. The bus output is capable of withstanding 60V. Sleep Mode and Silent Mode guarantee a very low current consumption.



## LIN Transceiver with 5V Regulator and Watchdog

ATA6621



Figure 1-1. Block Diagram

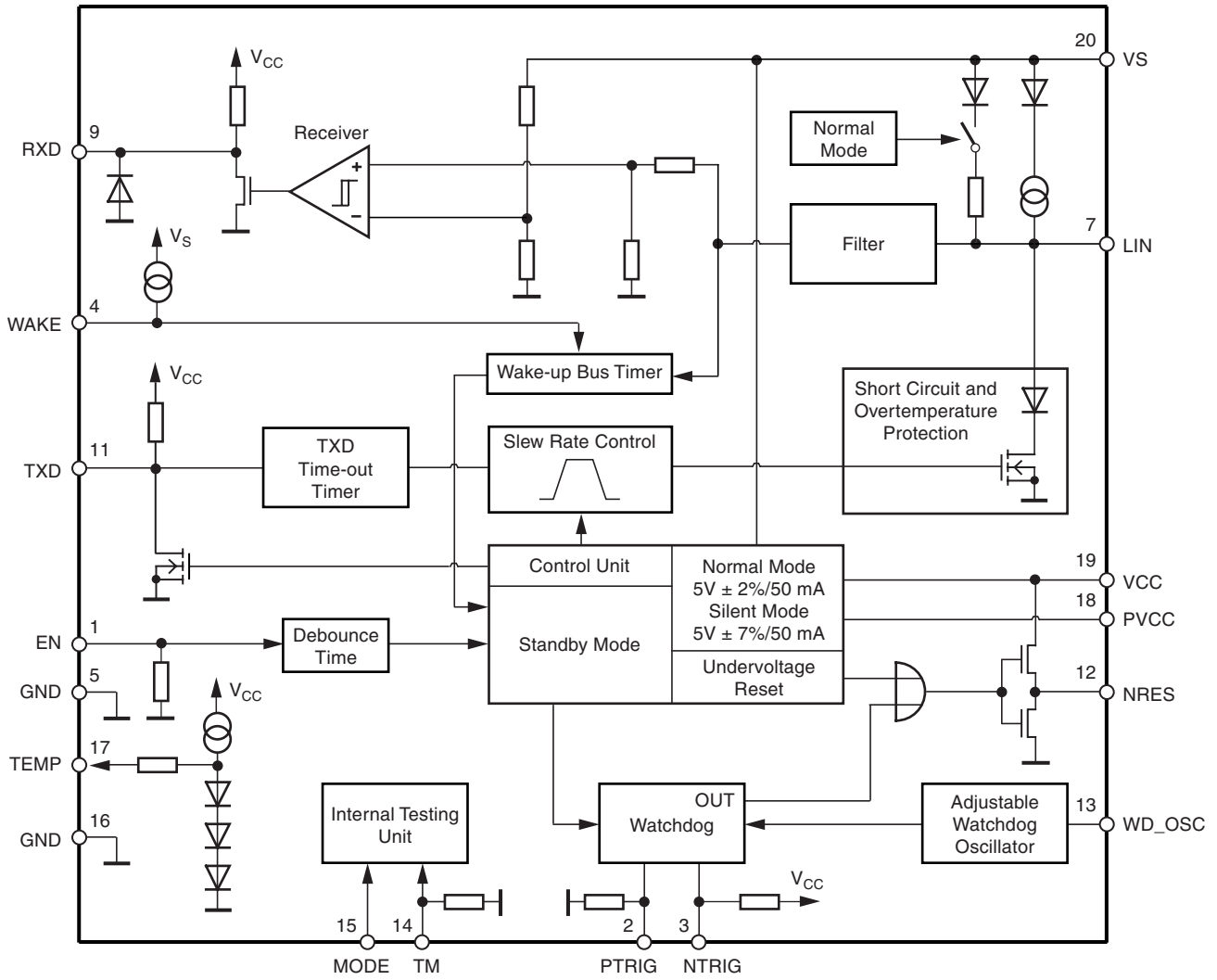

## 2. Pin Configuration

Figure 2-1. Pinning QFN20

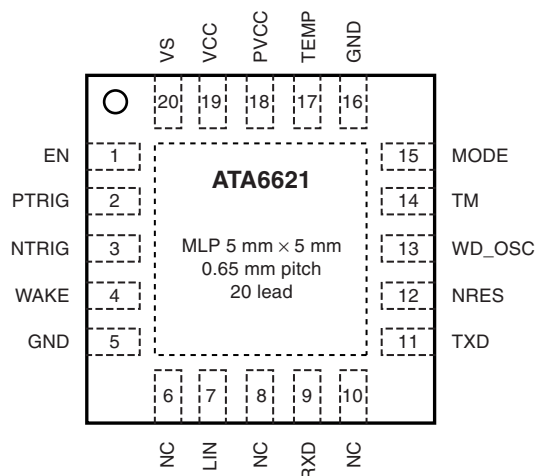

Table 2-1. Pin Description

Pin	Symbol	Function
1	EN	Enables the device into Normal Mode
2	PTRIG	High-level watchdog trigger input from microcontroller; if not needed, leave open or connect to GND
3	NTRIG	Low-level watchdog trigger input from microcontroller; if not needed, leave open or connect to VCC
4	WAKE	High-voltage input for local wake-up request; if not needed, connect to VS
5	GND	System ground
6	NC	Not connected
7	LIN	LIN bus line input/output
8	NC	Not connected
9	RXD	Receive data output
10	NC	Not connected
11	TXD	Transmit data input; active low output (strong pull down) after a local wake-up request
12	NRES	Output undervoltage and watchdog reset
13	WD_OSC	External resistor for adjustable watchdog timing
14	TM	For factory testing only (tie to ground)
15	MODE	For debug mode, high watchdog off, low watchdog on
16	GND	Additional ground
17	TEMP	Chip temperature output pin; if not needed connect to GND
18	PVCC	5V regulator sense input pin
19	VCC	5V regulator output/driver pin
20	VS	Battery supply
	Backside	Heat slug is connected to GND (pin 5)

## 3. Functional Description

### 3.1 Supply Pin (VS)

The LIN operating voltage is  $V_S = 5V$  to  $18V$ . An undervoltage detection is implemented to disable transmission if  $V_S$  falls below  $5V$  in order to avoid false bus messages. In this case the NRES switches to low and the IC enters prenormal mode. After switching on VS, the IC starts with the Pre Normal Mode and the voltage regulator is switched on (that is,  $5V/50$  mA output capability).

The supply current in Sleep Mode is typically  $10 \mu A$ , and  $40 \mu A$  in Silent Mode.

### 3.2 Ground Pin (GND)

The IC is neutral on the LIN pin in case of GND disconnection; it can handle a ground shift up to  $3V$  for supply voltage at the VS pin above  $9V$ .

### 3.3 Voltage Regulator Output Pin (VCC)

The internal  $5V$  voltage regulator is capable of driving loads with up to  $50$  mA of current consumption; it is able to supply the microcontroller and other ICs on the PCB. It is protected against overloads by means of current limitation and overtemperature shutdown. Furthermore, the output voltage is monitored and will cause a reset signal at the NRES output pin if the output voltage drops below a defined threshold  $V_{thun}$ . To boost up the maximum load current, an external NPN transistor may be used with its base connected to the VCC pin and its emitter connected to PVCC.

### 3.4 Voltage Regulator Sense Pin (PVCC)

This is the sense input pin of the  $5V$  voltage regulator. For normal applications (that is, when only using the internal output transistor), this pin is connected to the VCC pin. If an external boosting transistor is used, the PVCC pin must be connected to the output of this transistor, its emitter terminal.

### 3.5 Bus Pin (LIN)

A low side driver with internal current limitation and thermal shutdown, and an internal pull-up resistor in compliance with LIN specification 2.0 is implemented. This is a self-adapting current limitation; that is, during current limitation, as the chip temperature increases, the current decreases. The allowed voltage range is between  $-40V$  and  $+60V$ . Reverse currents from the LIN bus to VS are suppressed, even in case of ground shifts or battery disconnection. LIN receiver thresholds are compatible to the LIN protocol specification. The fall time from recessive bus state to dominant, and the rise time from dominant bus state to recessive are slope controlled.

### 3.6 Input Pin (TXD)

This pin is the microcontroller interface to control the state of the LIN output. TXD must be pulled to ground in order to have the LIN bus low. If TXD is high, the LIN output transistor is turned off and the bus is in the recessive state, pulled up by the internal resistor.

### 3.7 TXD Dominant Time-out Function

The TXD input has an internal pull-up resistor. An internal timer prevents the bus line from being driven permanently in the dominant state. If TXD is forced to low longer than  $t_{DOM} > 6$  ms, the LIN bus driver is switched to the recessive state. To reset this mode switch ( $> 10$   $\mu$ s) before switching LIN to dominant again.

### 3.8 Output Pin (RXD)

This pin reports the state of the LIN bus to the microcontroller. LIN high (recessive state) is reported by a high level at RXD, LIN low (dominant state) is reported by a low level at RXD. The output has an internal pull-up structure with typically 5 k $\Omega$  to  $V_{CC}$ . The AC characteristics can be defined with an external load capacitor of 20 pF.

The output is short-circuit protected. In Unpowered Mode (that is,  $V_S = 0V$ ), RXD is switched off.

### 3.9 Enable Input Pin (EN)

This pin controls the operation mode of the interface. If EN is high, the interface is in Normal Mode, with transmission paths from TXD to LIN and from LIN to RXD both being active. The  $V_{CC}$  voltage regulator is operating with 5V  $\pm 2\%$ /50 mA output capability.

If EN is switched to low while TXD is still high, the device is forced to Silent Mode. No data transmission is then possible and the current consumption is reduced to  $I_{VS} = 50$   $\mu$ A. The current capability of the  $V_{CC}$  regulator is also 50 mA, but the  $V_{CC}$  tolerance is between 4.65V and 5.35V.

If EN is switched to low while TXD is low, the device is forced to Sleep Mode. No data transmission is possible and the voltage regulator is switched off.

### 3.10 Wake Input Pin (WAKE)

This pin is a high voltage input used to wake the device up from Sleep Mode. It is usually connected to an external switch in the application to generate a local wake-up. A pull-up current source with typically 10  $\mu$ A is implemented.

If you don't need a local wake-up in your application, connect pin WAKE directly to pin VS.

### 3.11 MODE Input Pin

For normal watchdog operation connect pin MODE via an external resistor to GND (see [Figure 5-2 on page 23](#)). For debugging your software you can connect pin MODE to 5V and the watchdog is switched off.

### 3.12 TM Input Pin

Pin TM is used in final production measurement at Atmel. In the application it is always connected to GND.

### 3.13 Modes of Operation

Figure 3-1. Modes of Operation

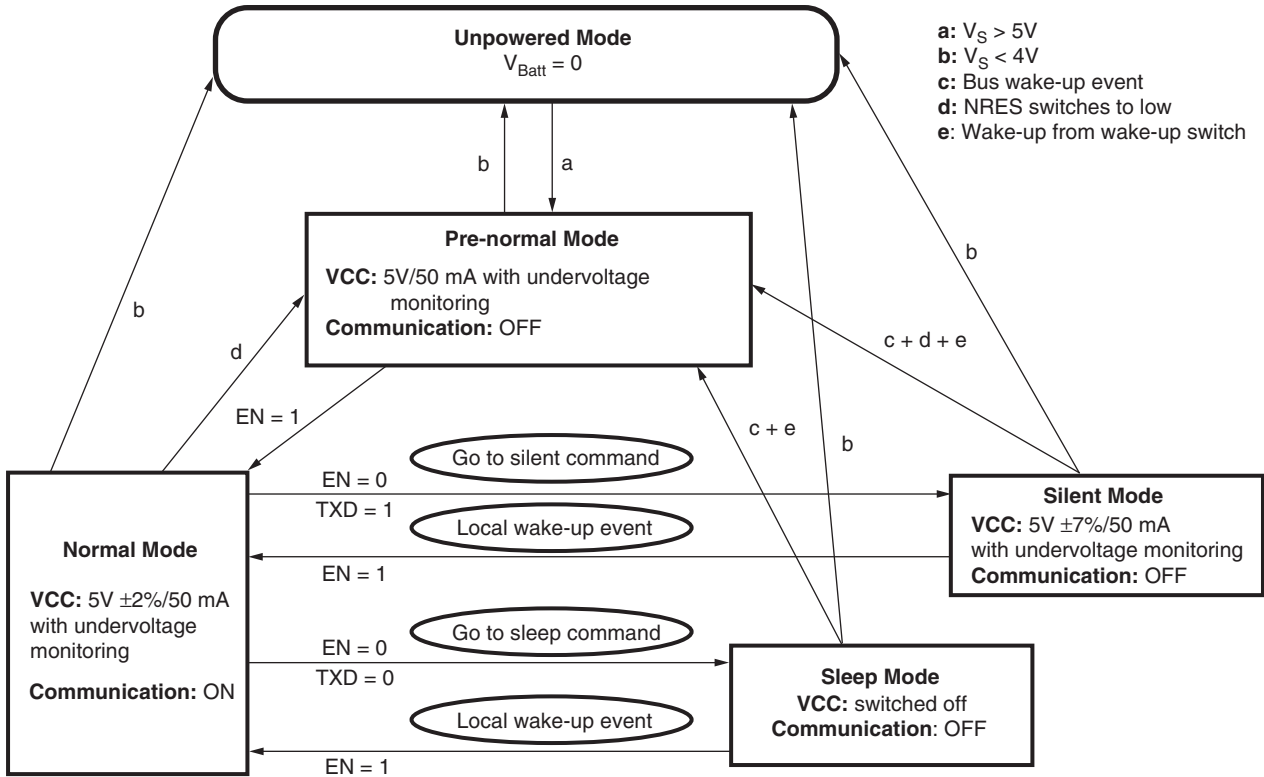

#### 3.13.1 Normal Mode

This is the normal transmitting and receiving mode. The voltage regulator is in normal mode and can source 50 mA. The undervoltage detection is activated. The watchdog needs a trigger signal from PTRIG or NTRIG to avoid resets at NRES.

#### 3.13.2 Silent Mode

A falling edge at EN while TXD is high switches the IC into Silent Mode. The TXD signal has to be logic high during the Mode Select window (Figure 3-2 on page 7). For EN and TXD either two independent outputs can be used, or two outputs from the same microcontroller port; in the second case, the mode change is only one command. In Silent Mode, the transmission path is disabled. Supply current from  $V_{Bat}$  is typically  $I_{VSSi} = 40 \mu A$  with no load at the VCC regulator.

The overall supply current from  $V_{Bat}$  is the addition of  $40 \mu A$  plus the  $V_{CC}$  regulator output current  $I_{VCCs}$ .

In Silent Mode, the 5V regulator is in low tolerance mode (4.65V to 5.35V) and can source up to 50 mA. The internal slave termination between pin LIN and pin VS is disabled to minimize the power dissipation in case pin LIN is shorted to GND. Only a weak pull-up current (typically 10  $\mu$ A) between pin LIN and pin VS is present.

The Silent Mode voltage tolerance is sufficient to run the internal timers of the microcontroller. The undervoltage reset is now  $V_{ccths} < 4.4V$ . If an undervoltage condition occurs, the NRES is switched to low and the ATA6621 changes state to Pre Normal Mode.

A falling edge at pin LIN followed by a dominant bus level maintained for a certain time period ( $T_{bus}$ ) results in a remote wake-up request. The device switches from Silent Mode to Pre Normal Mode. The internal LIN slave termination resistor is switched on. The remote wake-up request is indicated by a low level at pin RXD to interrupt the microcontroller. (Figure 3-5 on page 10)

With EN high, you can switch directly from Silent Mode to Normal Mode.

**Figure 3-2.** Switch to Silent Mode

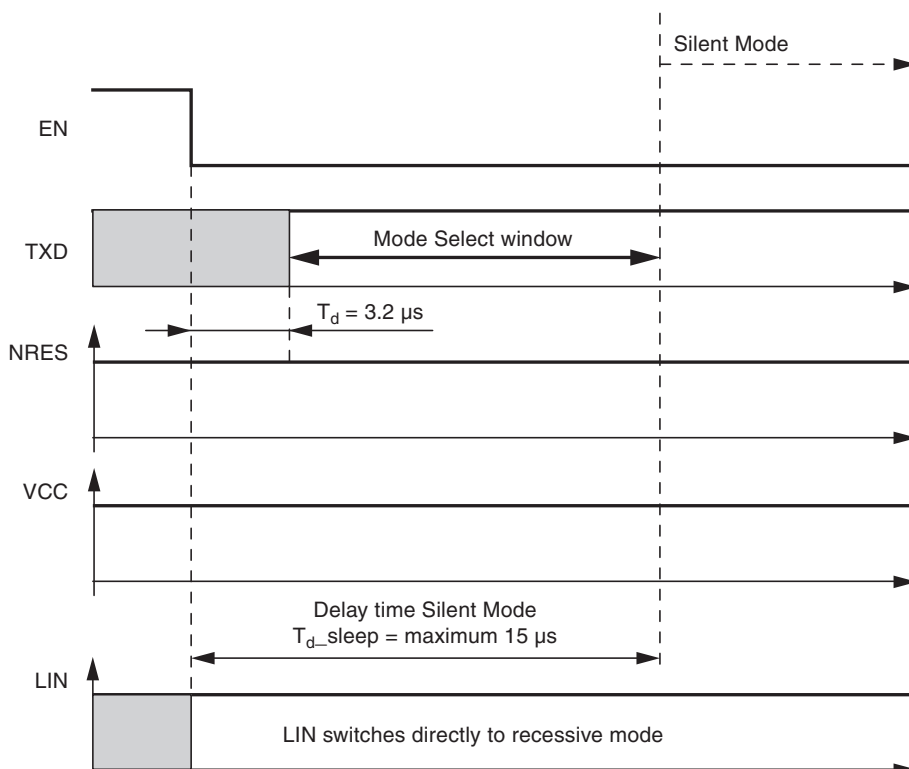

**Figure 3-3.** LIN Wake-up Waveform Diagram (from Silent Mode)

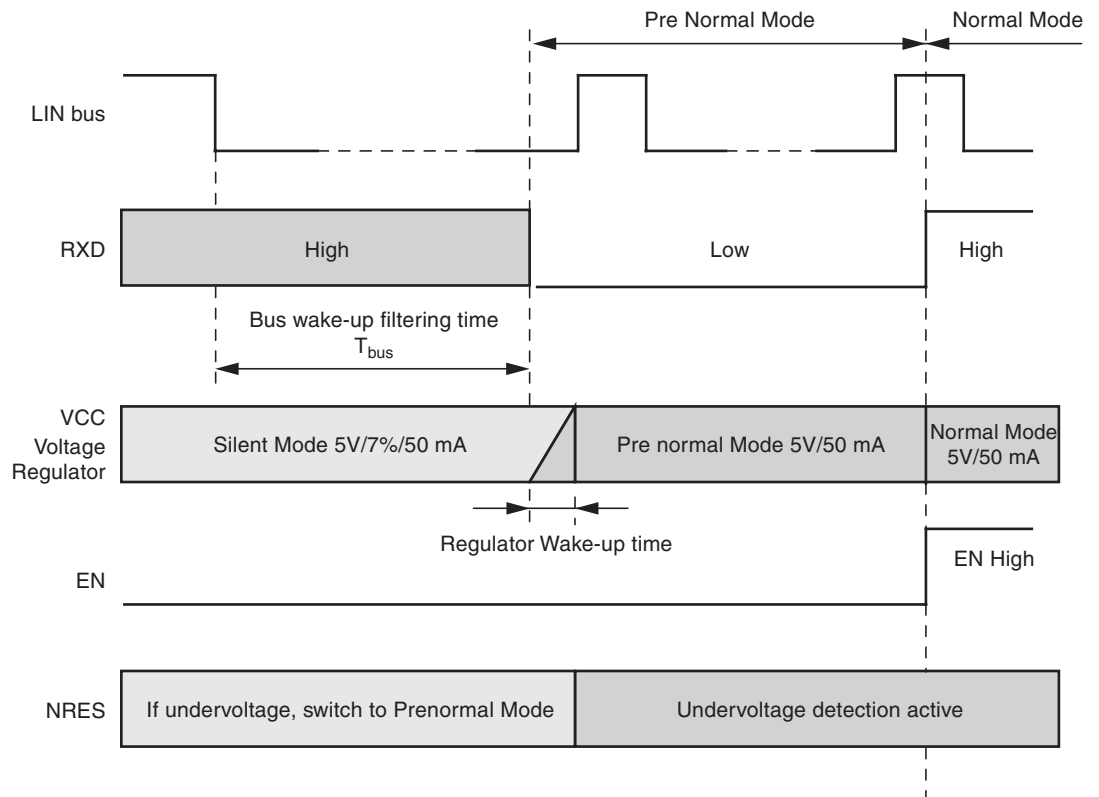

### 3.13.3 Sleep Mode

The falling edge at EN has to occur not more than  $t_{DOMmin} = 6 \text{ ms}$  after or  $3.2 \mu\text{s}$  before the falling edge at TXD in order to switch the IC into Sleep Mode. The TXD Signal has to stay logic low during the Mode Select window (Figure 3-4 on page 9). See also section “Silent Mode” on page 6.

In Sleep Mode the transmission path is disabled. Supply current from  $V_{Bat}$  is typically  $I_{V_{Sleep}} = 10 \mu\text{A}$ . The  $V_{CC}$  regulator is switched off. NRES and RXD are low. The internal slave termination between pin LIN and pin VS is disabled to minimize the power dissipation in case pin LIN is shorted to GND. Only a weak pull-up current (typically  $10 \mu\text{A}$ ) between pin LIN and pin VS is present.

A falling edge at pin LIN followed by a dominant bus level maintained for a certain time period ( $T_{bus}$ ) results in a remote wake-up request. The device switches from Sleep Mode to Pre Normal Mode. The VCC regulator is activated and the internal LIN slave termination resistor is switched on. The remote wake-up request is indicated by a low level at pin RXD to interrupt the microcontroller. (Figure 3-5 on page 10)

With EN high you can switch directly from Silent Mode to Normal Mode. In the application where the ATA6621 supplies the microcontroller, wake-up from Sleep Mode is only possible via LIN or pin WAKE.



Figure 3-4. Switch to Sleep Mode

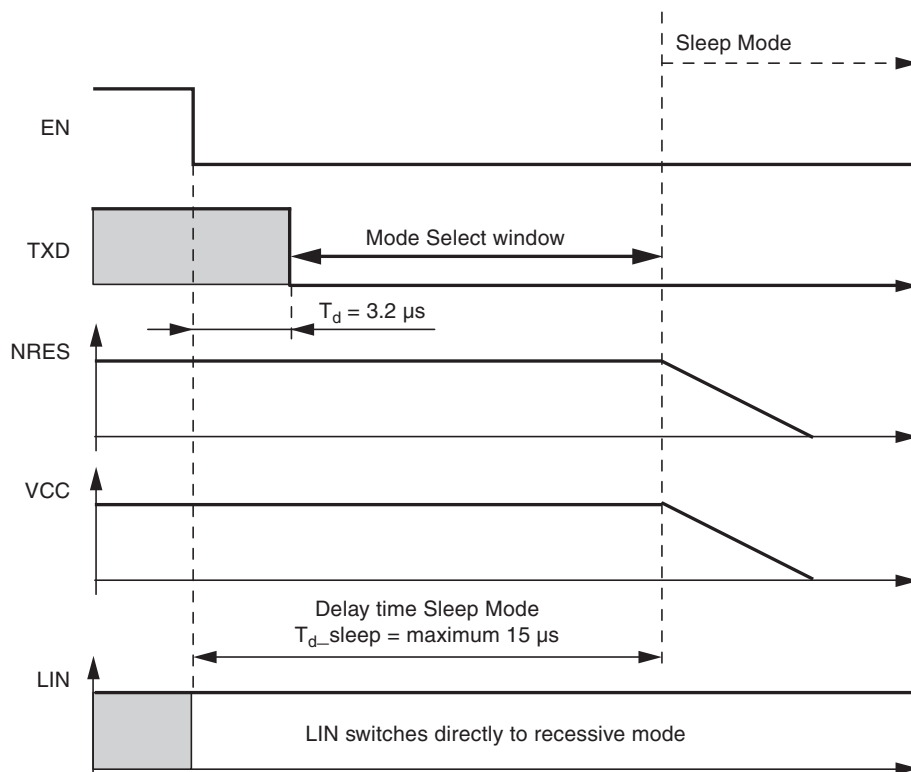

### 3.13.4 Pre Normal Mode

At system power-up the device automatically switches to Pre Normal Mode. The voltage regulator is switched on  $V_{CC} = 5V \pm 2\%/50 \text{ mA}$  (see [Figure 3-6 on page 12](#)). The NRES output switches to low for  $t_{res} = 10 \text{ ms}$  and sends a reset to the microcontroller. LIN communication is switched off and the watchdog is active. The ATA6621 stays in this mode until EN is switched to high.

If  $V_{\text{Battery}}$  ( $V_S < 4V$ ) is powered down during Silent Mode or Sleep Mode, the IC powers up into Pre Normal Mode.

### 3.13.5 Unpowered Mode

If you connect battery voltage to the application circuit, the voltage at the VS pin increases due to the block capacitor ([Figure 3-6 on page 12](#)). When  $V_S$  becomes higher than the  $V_S$  undervoltage threshold  $V_{S\_th}$ , the IC mode changes from Unpowered Mode to Pre Normal Mode. The  $V_{CC}$  output voltage reaches its nominal value after  $t_{VCC}$ . This time depends on the  $V_{CC}$  capacitor and the load.

The NRES is low for the reset time delay  $t_{reset}$ . During this time, no mode change is possible.

### 3.13.6 Debug Mode

The watchdog is switched off with pin MODE high (5V) and in normal operation if it is tied to GND (see [Figure 5-2 on page 23](#)).

**Figure 3-5.** LIN Wake-up Waveform Diagram from Sleep Mode

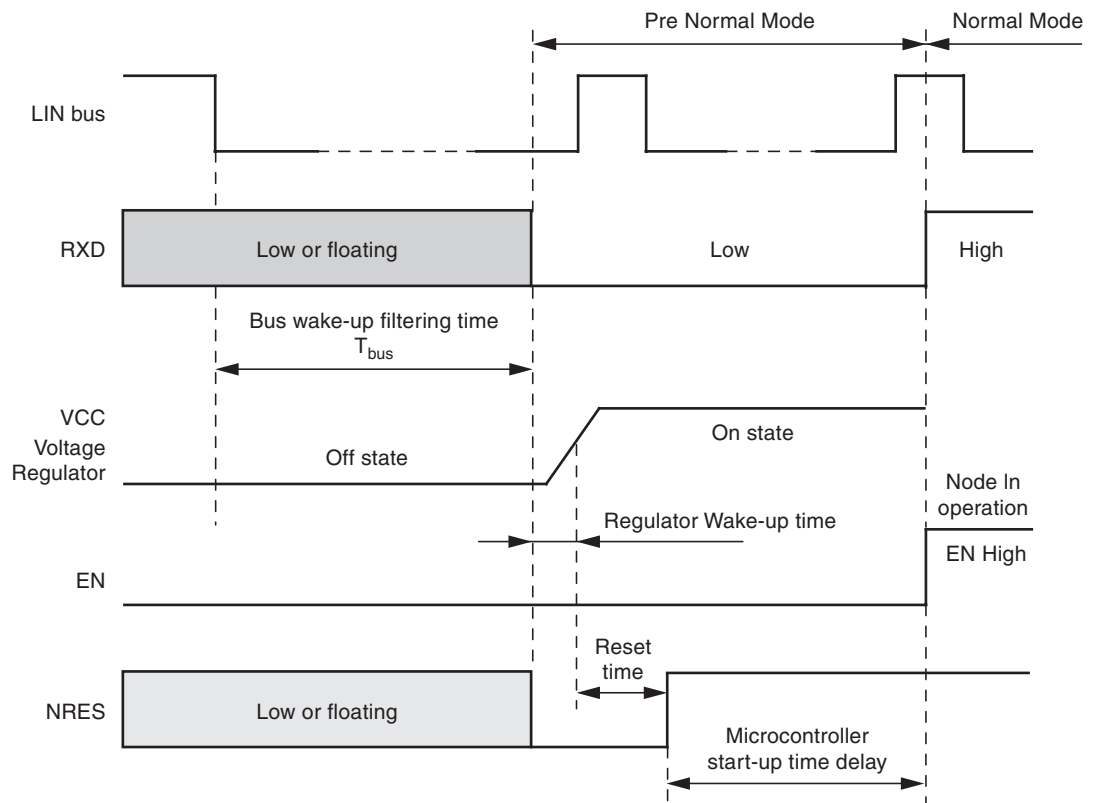

**Table 3-1.** Table of Modes

Mode of Operation	Transceiver	VCC	WD_OSC	TEMP	RXD	LIN
Pre Normal	Off	5V	2.5V	2V	5V	RECESSIVE
Normal	On	5V	2.5V	2V	5V	RECESSIVE
Silent	Off	5V	0V	0V	5V	RECESSIVE
Sleep	Off	0V	0V	0V	0V	RECESSIVE

### 3.14 Wake-up Scenarios from Silent or Sleep Mode

#### 3.14.1 Remote Wake-up via Dominant Bus State

A falling edge at pin LIN followed by a dominant bus level maintained for a certain time period ( $T_{BUS}$ ) results in a remote wake-up request. The device switches to Pre Normal Mode. The  $V_{CC}$  voltage regulator is activated, and the internal slave termination resistor is switched on. The remote wake-up request is indicated by a low level at pin RXD to generate an interrupt in the microcontroller. The watchdog needs a trigger signal from PTRIG or NTRIG within the lead time  $t_D$  to avoid resets at NRES. (Figure 3-2 on page 7)

#### 3.14.2 Local Wake-up via Pin Wake

A falling edge at pin WAKE followed by a low level maintained for a certain time period ( $T_{WAKE}$ ) results in a local wake-up request. The extra long wake-up time ( $T_{WAKE}$ ) ensures that no transients as defined in ISO7637 create a wake-up. The device switches to Pre Normal Mode. The internal slave termination resistor is switched on. The local wake-up request is indicated by a low level at pin RXD to generate an interrupt in the microcontroller. The watchdog needs a trigger signal from PTRIG or NTRIG within the lead time  $t_D$  to avoid resets at NRES.

#### 3.14.3 Wake-up Source Recognition

The device can distinguish between a local wake-up request (pin WAKE) and a remote wake-up request (dominant LIN bus state). The wake-up source can be read on pin TXD in Pre Normal Mode. A high level indicates a remote wake-up request (weak pull down at pin TXD) and a low level indicates a local wake-up request (strong pull down at pin TXD). The wake-up request flag (signalled on pin RXD) as well as the wake-up source flag (signalled on pin TXD) are reset immediately, if the microcontroller sets pin EN to high (Figure 3-2 on page 7 and Figure 3-3 on page 8).

### 3.15 Fail-safe Features

- During a short circuit at LIN, the output limits the output current to  $I_{BUS\_LIM}$ . Due to the power dissipation, the chip temperature exceeds  $T_{LINoff}$  and the LIN output is switched off. The chip cools down and after a hysteresis of  $T_{hys}$ , switches the output on again. During LIN overtemperature switch-off, the  $V_{CC}$  regulator works independently.
- The reverse current at pin LIN is very low ( $< 3 \mu A$ ) during loss of  $V_{BAT}$  or GND. This is optimal behavior for bus systems where some slave modes are supplied from battery or ignition.
- During a short circuit at  $V_{CC}$ , the output limits the output current to  $I_{VCCn}$ . Because of undervoltage, NRES switches to low and sends a reset to the microcontroller. The IC switches into Pre Normal Mode. If the chip temperature exceeds the value  $T_{VCCoff}$ , the  $V_{CC}$  output switches off. The chip cools down and after a hysteresis of  $T_{hys}$ , switches the output on again. Because of Pre Normal Mode, the  $V_{CC}$  voltage will switch on again although EN is switched off from the microcontroller. The microcontroller can start its normal operation.
- Pin EN provides a pull-down resistor to force the transceiver into recessive mode if EN is disconnected.
- Pin RXD is connected with  $5 k\Omega$  to  $V_{CC}$ , if  $V_{Batt}$  is disconnected  $V_{CC}$  is at GND level
- Pin TXD provides a pull-up resistor to force the transceiver into recessive mode if TXD is disconnected.
- If the WD\_OSC pin has a short circuit to GND or the resistor is disconnected, the watchdog oscillator runs with a high frequency and guarantees a reset in any condition.

- The WD\_OSC pin is a constant voltage regulator which supplies 2.5V for the external resistor ROsc to adjust the watchdog timing. This output is short circuit protected. A short circuit to GND causes a reset a pin NRES after typically 4 ms. An open circuit causes a reset at pin NRES after typically 7 ms.

### 3.16 Voltage Regulator

The voltage regulator needs an external capacitor for compensation and to smooth the disturbances from the microcontroller. It is recommend to use an tantalum capacitor with  $C > 10 \mu\text{F}$  and a ceramic capacitor with  $C = 100 \text{ nF}$ . The values of these capacitors can be varied by the customer, depending on the application.

During mode change from Silent to Normal Mode, the voltage regulator ramps up to 6V for only a few microseconds before it drops back to 5V. This behavior depends on the value of the load capacitor. With  $4.7 \mu\text{F}$ , the overshoot voltage has its greatest value. This voltage decreases with higher or lower load capacitors.

The main power dissipation of the IC is created from the  $V_{CC}$  output current  $I_{VCC}$ , which is needed for the application.

In [Figure 3-7 on page 13](#) you see the safe operating range of the ATA6621.

**Figure 3-6.** VCC Voltage Regulator: Ramp Up and Undervoltage

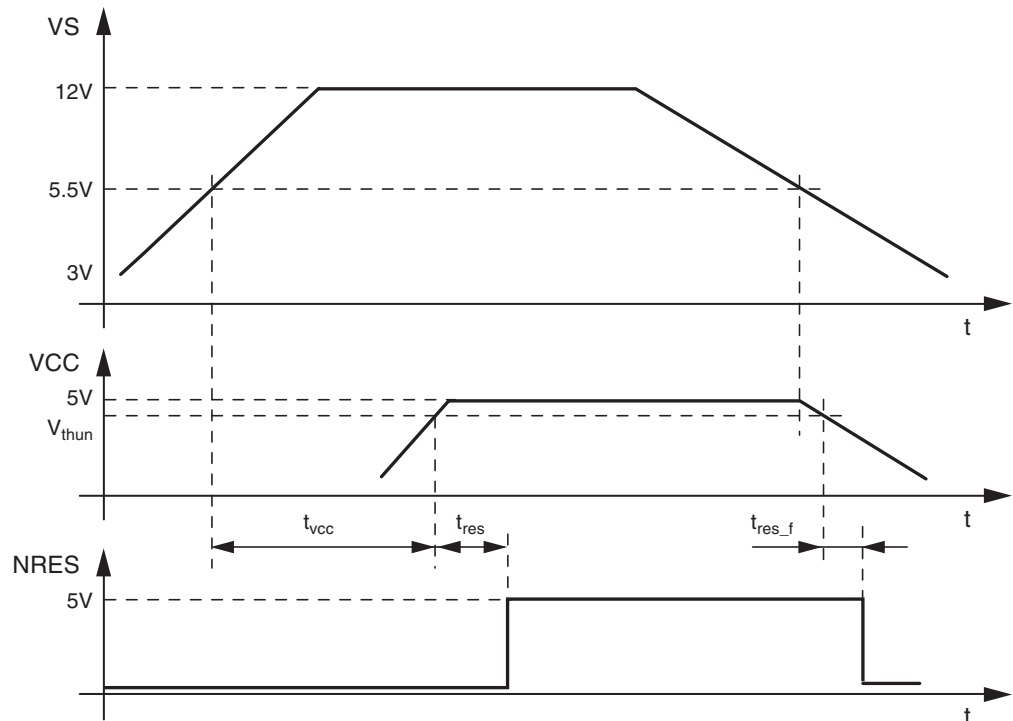

**Figure 3-7.** Power Dissipation: Safe Operating Area versus  $V_{CC}$  Output Current and Supply Voltage  $V_S$  at Different Ambient Temperatures

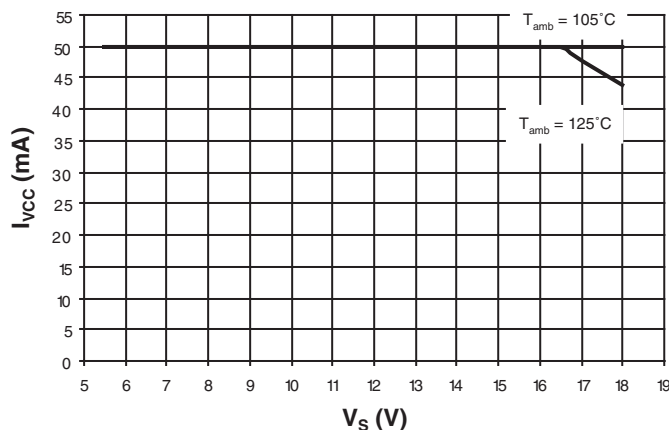

### 3.17 Watchdog

The watchdog anticipates a trigger signal from the microcontroller at the NTRIG (negative edge) or the PTRIG (positive edge) input within a period time window of  $T_{wd}$ . The trigger signal must exceed a minimum time  $t_{trigmin} > 3 \mu\text{s}$ . If a triggering signal is not received, a reset signal will be generated at output NRES. The timing basis of the watchdog is provided by the internal oscillator, of which the time period  $T_{osc}$  is adjustable via the external resistor  $R_{wd\_osc}$  (10 k $\Omega$  to 120 k $\Omega$ ).

In Silent or Sleep Mode, the watchdog is switched off to reduce current consumption.

Minimum time for first watchdog pulse is required after the undervoltage reset at NRES disappears and is defined as lead time  $t_d$ .

#### 3.17.1 Typical Timing Sequence with $R_{wd\_osc} = 51 \text{ k}\Omega$

The trigger signal  $T_{wd}$  is adjustable between 2.9 ms and 33 ms via the external resistor  $R_{wd\_osc}$ .

For example, with an external resistor of  $R_{wd\_oscSC} = 51 \text{ k}\Omega \pm 1\%$ , the typical parameters of the watchdog come out as follows:

$$t_{osc} = 12.5 \mu\text{s due to } 51 \text{ k}\Omega$$

$$t_d = 3922 \times 12.5 \mu\text{s} = 49 \text{ ms}$$

$$t_1 = 800 \times 12.5 \mu\text{s} = 10 \text{ ms}$$

$$t_2 = 840 \times 12.5 \mu\text{s} = 10.5 \text{ ms}$$

$$t_{nres} = 157 \times 12.5 \mu\text{s} = 1.96 \text{ ms}$$

After ramping up the battery voltage  $V_S$  or wake up from Sleep Mode, the 5V regulator is switched on. The reset output NRES stays low for the time  $t_{\text{reset}}$  (typically 10 ms), then it switches to high and the watchdog waits for the watchdog sequence from the microcontroller. This lead time  $t_d$  follows after the reset and is  $t_d = 49$  ms. After wake up from Silent Mode the RXD switches to low. The lead time  $t_d$  follows the negative edge of this RXD signal. In this time, the first watchdog pulse from the microcontroller is required. If the trigger pulse NTRIG (or PTRIG, as the case may be) occurs during this time, the time  $t_1$  starts immediately. If no trigger signal occurs during the time  $t_d$ , a watchdog reset with  $t_{\text{NRES}} = 1.96$  ms will reset the microcontroller after  $t_d = 49$  ms. The times  $t_1$  and  $t_2$  have a fixed relationship with each other. A triggering signal from the microcontroller is anticipated within the time frame of  $t_2 = 10.5$  ms. To avoid false triggering from glitches, the trigger pulse must be longer than  $t_{\text{trigg}} > 3 \mu\text{s}$ . This slope serves to restart the watchdog sequence. Should the triggering signal fail in this open window  $t_2$ , the NRES output will be drawn to ground after  $t_2$ . A triggering signal during the closed window  $t_1$  causes NRES to immediately switch low.

**Figure 3-8.** Timing Sequence with  $R_{\text{WD\_OSC}} = 51 \text{ k}\Omega$

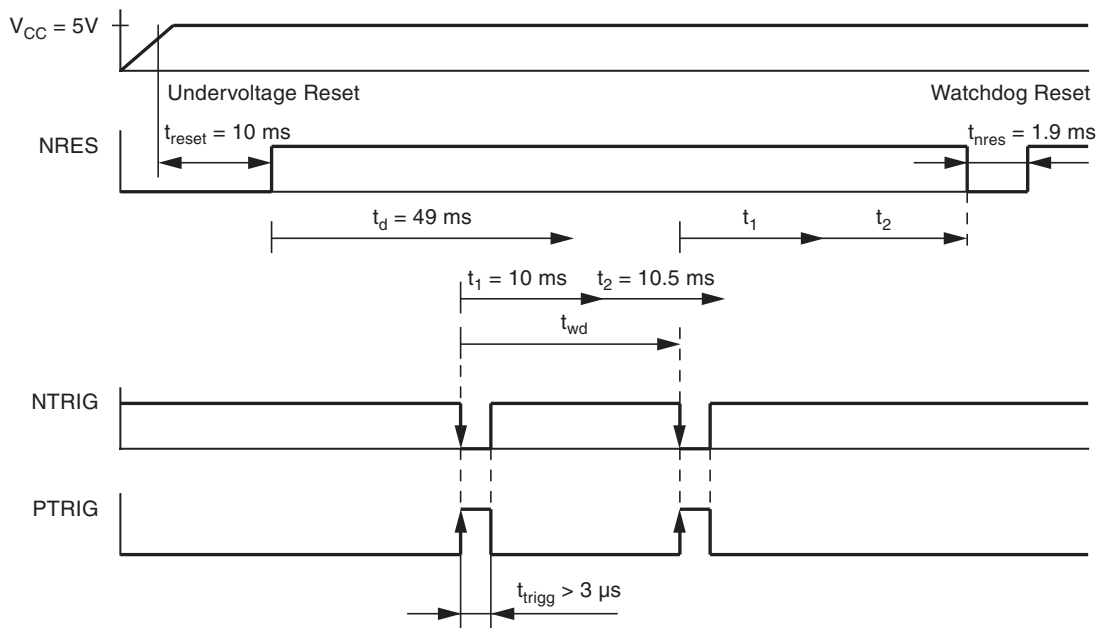

### 3.17.2 Worst Case Calculation with $R_{\text{WO\_OSC}} = 51 \text{ k}\Omega$

The internal oscillator has a tolerance of  $\pm 20\%$ . This means that  $t_1$  and  $t_2$  can also vary by  $\pm 20\%$ . The worst case calculation for the watchdog period  $T_{\text{wd}}$  the microcontroller has to provide is calculated as follows.

The ideal watchdog time  $T_{\text{wd}}$  is between ( $t_1$  maximum) and ( $t_1$  minimum plus  $t_2$  minimum).

$$t_{1,\text{min}} = 0.8 \times t_1 = 8 \text{ ms}, \quad t_{1,\text{max}} = 1.2 \times t_1 = 12 \text{ ms}$$

$$t_{2,\text{min}} = 0.8 \times t_2 = 8.4 \text{ ms}, \quad t_{2,\text{max}} = 1.2 \times t_2 = 12.6 \text{ ms}$$

$$T_{\text{wdmax}} = t_{1\text{min}} + t_{2\text{min}} = 8 \text{ ms} + 8.4 \text{ ms} = 16.4 \text{ ms}$$

$$T_{\text{wdmin}} = t_{1\text{max}} = 12 \text{ ms}$$

$$T_{\text{wd}} = 14.2 \text{ ms} \pm 2.2 \text{ ms} (\pm 15\%)$$

A microcontroller with an oscillator tolerance of  $\pm 15\%$  is sufficient to supply the trigger inputs correctly within the time period of  $T_{wd} = 14.2 \text{ ms}$  ( $\pm 15\%$ ) in an application with  $R_{wd\_osc} = 51 \text{ k}\Omega$

**Table 3-2.** Table of Watchdog Timings

Rwd_osc k $\Omega$	Oscillator Period $t_{osc}/\mu\text{s}$	Lead Time $t_d/\text{ms}$	Closed Window $t_1/\text{ms}$	Open Window $t_2/\text{ms}$	Trigger Period from microcontroller $t_{wd}/\text{ms}$	Reset time $t_{nres}/\text{ms}$
10	2.6	10.2	2.08	2.18	2.90	0.41
51	12.5	49.4	10	10.5	14.2	1.96
91	22.4	87.8	17.92	18.82	25.45	3.52
120	29	113.7	23.2	24.36	32.94	4.55

### 3.18 Temperature Monitor at Pin TEMP

In addition to the internal temperature monitoring of the voltage regulator, an additional sensor measures the junction temperature and provides a linearized voltage at the TEMP pin. Together with the analog functions of the microcontroller (for example, the analog comparator and the Analog-to-digital converter (ADC)), this enables the application to detect overload conditions and to take corresponding measures in order to prevent damage. An external capacitor buffers the voltage due to the input current of the ADC.

The sensor itself is built out of three diodes which are supplied by an internal BIAS current in Pre Normal Mode and Normal Mode. The typical voltage at  $T = 27^\circ\text{C}$  is  $V_{temp} = 2.2\text{V}$  with a typical negative temperature coefficient of  $V_{TC,TEMP} = -5.05 \text{ mV/k}$ . In silent and sleep mode the  $20 \mu\text{A}$  current source is switched off.

**Figure 3-9.** Temperature Monitor

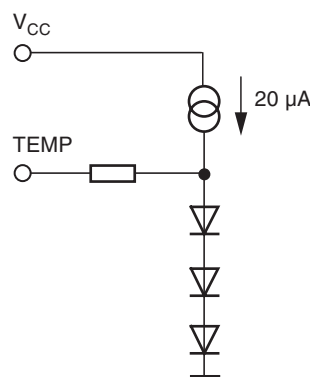

## 4. Absolute Maximum Ratings

Stresses beyond those listed under “Absolute Maximum Ratings” may cause permanent damage to the device. This is a stress rating only and functional operation of the device at these or any other conditions beyond those indicated in the operational sections of this specification is not implied. Exposure to absolute maximum rating conditions for extended periods may affect device reliability.

Parameters	Symbol	Min	Typ	Max	Unit
Supply voltage $V_S$	$V_S$	-0.3		+40	V
Pulse time $\leq 500$ ms T = 25°C Output current $I_{VCC} \leq 50$ mA	$V_S$			+40	V
Pulse time $\leq 2$ min T = 25°C Output current $I_{VCC} \leq 50$ mA	$V_S$			27	V
WAKE DC and transient voltage (with 33 k $\Omega$ serial resistor) Transient voltage due to ISO7637 (coupling 1 nF)		-40 -150		+40 +100	V
Logic pins (RXD, TXD, EN, NRES, PTRIG, NTRIG, VCC, PVCC, WD_OSC, TEMP)		-0.3		+6.5	V
LIN - DC voltage - Transient voltage		-40 -150		+60 +100	V
$V_{CC}$ DC voltage		-0.3		6.5	V
ESD (DIN EN 6100-4-2) According LIN EMC Test Specification 1.3 - Pin VS, LIN to GND - Pin WAKE (33 k $\Omega$ serial resistor)		$\pm 6$ $\pm 5$			KV KV
ESD HBM - All pins according to ESD S 5.1		$\pm 2$			KV
CDM ESD STM 5.3.1-1999 - All pins		$\pm 1$			KV
Junction temperature	$T_j$	-40		+150	°C
Storage temperature	$T_s$	-55		+150	°C
Operating ambient temperature	$T_a$	-40		+125	°C
Thermal resistance junction to heat slug	$R_{thjc}$			10	K/W
Thermal resistance junction to ambient, where heat slug is soldered to PCB	$R_{thja}$		35		K/W
Thermal shutdown of $V_{CC}$ regulator		150	165	170	°C
Thermal shutdown of LIN output		150	165	170	°C
Thermal shutdown hysteresis			10		°C



## 5. Electrical Characteristics

$5V < V_S < 18V$ ,  $T_{amb} = -40^{\circ}C$  to  $+125^{\circ}C$

No.	Parameters	Test Conditions	Pin	Symbol	Min	Typ	Max	Unit	Type*
<b>1</b>	<b>VS Pin</b>								
1.1	Nominal DC voltage range			$V_S$	5		18	V	A
1.2	Supply current in Sleep Mode	Sleep Mode $V_{lin} > V_{Bat} - 0.5V$ $V_{Bat} < 14V$ (25°C to 125°C)		$I_{VSsleep}$		10	20	$\mu A$	A
1.3	Supply current in Silent Mode	Bus recessive; $V_{Bat} < 14V$ (25°C to 125°C) Without load at VCC		$I_{VSSi}$		40	50	$\mu A$	A
1.4	Supply current in Normal Mode	Bus recessive Without load at VCC		$I_{VSrec}$			4	mA	A
1.5	Supply current in Normal Mode	Bus dominant VCC load current 50 mA		$I_{VSdom}$			55	mA	A
1.6	VS undervoltage threshold			$VS_{th}$	4.15	4.5	5	V	A
1.7	VS undervoltage threshold hysteresis			$VS_{th\_hys}$		0.2		V	A
<b>2</b>	<b>RXD Output Pin</b>								
2.1	Low-level input current	Normal Mode; $V_{LIN} = 0V$ $V_{RXD} = 0.4V$		IRXD	2	5	8	mA	A
2.2	Low-level output voltage	$I_{RXD} = 1 mA$		VRXDL			0.3	V	A
2.3	Internal 5 k $\Omega$ resistor to VCC			RRXD	3		7	k $\Omega$	A
<b>3</b>	<b>TXD Input Pin</b>								
3.1	Low-level voltage input			$V_{TXDL}$	-0.3		+1.5	V	A
3.2	High-level voltage input			$V_{TXDH}$	3.5		VCC + 0.3V	V	A
3.3	Pull-up resistor	$V_{TXD} = 0V$		$R_{TXD}$	125	250	600	k $\Omega$	A
3.4	High-level leakage current	$V_{TXD} = 5V$		$I_{TXD}$	-3		+3	$\mu A$	A
3.5	Low-level input current at local wake-up request	Pre Normal Mode; $V_{LIN} = V_{Battery}$ $V_{WAKE} = 0V$ $V_{TXD} = 0.4V$		$I_{TXDwake}$	2	5	8	mA	A

\*) Type means: A = 100% tested, B = 100% correlation tested, C = Characterized on samples, D = Design parameter

## 5. Electrical Characteristics (Continued)

5V < V<sub>S</sub> < 18V, T<sub>amb</sub> = -40°C to +125°C

No.	Parameters	Test Conditions	Pin	Symbol	Min	Typ	Max	Unit	Type*
<b>4</b>	<b>EN Input Pin</b>								
4.1	Low-level voltage input			V <sub>ENL</sub>	-0.3		+1.5	V	A
4.2	High-level voltage input			V <sub>ENH</sub>	3.5		VCC + 0.3V	V	A
4.3	Pull-down resistor	V <sub>EN</sub> = 5V		R <sub>EN</sub>	125	250	600	kΩ	A
4.4	Low-level input current	V <sub>EN</sub> = 0V		I <sub>EN</sub>	-3		+3	μA	A
<b>5</b>	<b>NRES Output Pin</b>								
5.1	High-level output voltage	V <sub>S</sub> ≥ 5.5V; I <sub>nres</sub> = -1 mA		V <sub>NRESH</sub>	4.5			V	A
5.2	Low-level output voltage	V <sub>S</sub> ≥ 5.5V; I <sub>nres</sub> = -1 mA I <sub>nres</sub> = -250 μA		V <sub>NRESL</sub>			0.2 0.14	V V	A A
5.3	Low-level output low	10 kΩ to VCC; V <sub>CC</sub> = 0.8V		V <sub>NRESLL</sub>			0.3	V	A
5.4	Undervoltage reset time	V <sub>VS</sub> ≥ 5.5V C <sub>NRES</sub> = 20 pF		t <sub>reset</sub>	7		13	ms	A
5.5	Reset debounce time for falling edge	V <sub>VS</sub> ≥ 5.5V C <sub>NRES</sub> = 20 pF		t <sub>res_f</sub>			3	μs	A
<b>6</b>	<b>Voltage Regulator VCC Pin in Normal and Pre Normal Mode</b>								
6.1	Output voltage VCC	5.5V < V <sub>S</sub> < 18V (0 mA to 50 mA)		VCC <sub>nor</sub>	4.9		5.1	V	A
6.2	Output voltage VCC at low VS	3.3V < V <sub>S</sub> < 5.5V		VCC <sub>low</sub>	V <sub>VS</sub> - V <sub>D</sub>		5.1	V	A
6.3	Regulator drop voltage	V <sub>S</sub> > 4.0V, I <sub>VCC</sub> = -20 mA		V <sub>D1</sub>			250	mV	A
6.4	Regulator drop voltage	V <sub>S</sub> > 4.0V, I <sub>VCC</sub> = -50 mA		V <sub>D2</sub>			500	mV	A
6.5	Regulator drop voltage	V <sub>S</sub> > 3.3V, I <sub>VCC</sub> = -15 mA		V <sub>D3</sub>			200	mV	A
6.6	Output current	V <sub>S</sub> > 3V		I <sub>VCC</sub>	-50			mA	A
6.7	Output current limitation	V <sub>S</sub> > 0V		I <sub>VCCs</sub>	-200	-130		mA	A
6.8	Load capacity	1Ω < ESR < 5Ω		C <sub>load</sub>	1.8	2.2		μF	D
6.9	VCC undervoltage threshold	Referred to VCC V <sub>S</sub> > 5.5V		V <sub>thunN</sub>	4.4		4.8	V	A
6.10	Hysteresis of undervoltage threshold	Referred to VCC V <sub>S</sub> > 5.5V		V <sub>hys<sub>thun</sub></sub>	30			mV	A
6.11	Ramp up time V <sub>S</sub> > 5.5V to VCC > 4.9V	C <sub>VCC</sub> = 4.7 μF No load		t <sub>VCC</sub>			300	μs	A
<b>7</b>	<b>Voltage Regulator VCC Pin in Silent Mode</b>								
7.1	Output voltage VCC	5.5V < V <sub>S</sub> < 18V (0 mA to 50 mA)		VCC <sub>nor</sub>	4.65		5.35	V	A
7.2	Output voltage VCC at low VS	3.3V < V <sub>S</sub> < 5.5V		VCC <sub>low</sub>	V <sub>VS</sub> - V <sub>D</sub>		5.1	V	A
7.3	Regulator drop voltage	V <sub>S</sub> > 3.3V, I <sub>VCC</sub> = -15 mA		V <sub>D</sub>			200	mV	A

\*) Type means: A = 100% tested, B = 100% correlation tested, C = Characterized on samples, D = Design parameter

## 5. Electrical Characteristics (Continued)

5V < V<sub>S</sub> < 18V, T<sub>amb</sub> = -40°C to +125°C

No.	Parameters	Test Conditions	Pin	Symbol	Min	Typ	Max	Unit	Type*
7.4	At VCC undervoltage threshold the state switches back to Pre Normal Mode	Referred to VCC V <sub>S</sub> > 5.5		V <sub>thunS</sub>	3.9		4.4	V	A
7.5	Hysteresis of undervoltage threshold	Referred to VCC V <sub>S</sub> > 5.5V		V <sub>hys</sub> <sub>thun</sub>	40			mV	D
7.6	Output current limitation	V <sub>S</sub> > 0V		I <sub>VCCs</sub>	-200	-130		mA	A
<b>8</b>	<b>LIN Bus Driver: Bus Load Conditions: Load1 (Small): 1 nF, 1 kΩ; Load2 (Large): 10 nF, 500Ω; R<sub>RXD</sub> = 5 kΩ; C<sub>RXD</sub> = 20 pF 10.5, 10.6 and 10.7 Specify the Timing Parameters for Proper Operation at 20 Kbps</b>								
8.1	Driver recessive output voltage	Load1 / Load2		V <sub>BUSrec</sub>	0.9 V <sub>S</sub>		V <sub>S</sub>	V	A
8.2	Driver dominant voltage	V <sub>VS</sub> = 7V R <sub>load</sub> = 500Ω		V <sub>LoSUP</sub>			1.2	V	A
8.3	Driver dominant voltage	V <sub>VS</sub> = 18V R <sub>load</sub> = 500Ω		V <sub>HiSUP</sub>			2	V	A
8.4	Driver dominant voltage V <sub>BUSdom_DRV_LoSUP</sub>	V <sub>VS</sub> = 7V R <sub>load</sub> = 1000Ω		V <sub>LoSUP_1k</sub>	0.6			V	A
8.5	Driver dominant voltage	V <sub>VS</sub> = 18V R <sub>load</sub> = 1000Ω		V <sub>HiSUP_1k_</sub>	0.8			V	A
8.6	Pull-up resistor to VS	The serial diode is mandatory		R <sub>LIN</sub>	20	30	60	kΩ	A
8.7	Self-adapting current limitation V <sub>Bus</sub> = V <sub>Batt_max</sub>	T <sub>j</sub> = 125°C T <sub>j</sub> = 27°C T <sub>j</sub> = -40°C		I <sub>BUS_LIM</sub>	52 100 120		110 170 230	mA mA mA	A
8.8	Input leakage current at the receiver including pull-up resistor as specified	Input leakage current Driver off V <sub>BUS</sub> = 0V V <sub>Battery</sub> = 12V		I <sub>BUS_PAS_dom</sub>	-1			mA	A
8.9	Leakage current LIN recessive	Driver off 8V < V <sub>Battery</sub> < 18V 8V < V <sub>BUS</sub> < 18V V <sub>BUS</sub> ≥ V <sub>Batt</sub>		I <sub>BUS_PAS_rec</sub>		15	20	μA	A
8.10	Leakage current when control unit disconnected from ground. Loss of local ground must not affect communication in the residual network	GND <sub>Device</sub> = V <sub>S</sub> V <sub>Battery</sub> = 12V 0V < V <sub>BUS</sub> < 18V		I <sub>BUS_NO_gnd</sub>	-10	0.5	10	μA	A
8.11	Node has to sustain the current that can flow under this condition. Bus must remain operational under this condition	V <sub>Battery</sub> disconnected V <sub>SUP_Device</sub> = GND 0V < V <sub>BUS</sub> < 18V		I <sub>BUS</sub>		0.5	3	μA	A

\*) Type means: A = 100% tested, B = 100% correlation tested, C = Characterized on samples, D = Design parameter

## 5. Electrical Characteristics (Continued)

5V < V<sub>S</sub> < 18V, T<sub>amb</sub> = -40°C to +125°C

No.	Parameters	Test Conditions	Pin	Symbol	Min	Typ	Max	Unit	Type*
<b>9</b>	<b>LIN Bus Receiver</b>								
9.1	Center of receiver threshold	$V_{BUS\_CNT} = (V_{th\_dom} + V_{th\_rec}) / 2$		V <sub>BUS_CNT</sub>	0.475 V <sub>S</sub>	0.5 V <sub>S</sub>	0.525 - V <sub>S</sub>	V	A
9.2	Receiver dominant state	V <sub>EN</sub> = 5V		V <sub>BUSdom</sub>	-27		0.4 V <sub>S</sub>	V	A
9.3	Receiver recessive state	V <sub>EN</sub> = 5V		V <sub>BUSrec</sub>	0.6 V <sub>S</sub>		40	V	A
9.4	Receiver input hysteresis	V <sub>HYS</sub> = V <sub>th_rec</sub> - V <sub>th_dom</sub>		V <sub>BUSHys</sub>	0.028 V <sub>S</sub>	0.1 V <sub>S</sub>	0.175 V <sub>S</sub>	V	A
9.5	Wake detection LIN High-level input voltage			V <sub>LINH</sub>	V <sub>S</sub> - 1V		V <sub>S</sub> + 0.3V	V	A
9.6	Wake detection LIN Low-level input voltage	Initializes a wake-up signal		V <sub>LINL</sub>	-27		V <sub>S</sub> - 3.3V	V	A
<b>10</b>	<b>Internal Timers</b>								
10.1	Dominant time for wake-up via LIN bus	V <sub>LIN</sub> = 0V		T <sub>bus</sub>	30	90	150	μs	A
10.2	Time delay for mode change from Pre Normal to Normal Mode via pin EN	V <sub>EN</sub> = 5V		T <sub>norm</sub>	5	15	20	μs	A
10.3	Time delay for mode change from Normal into Sleep Mode via pin EN	V <sub>EN</sub> = 0V		T <sub>sleep</sub>	2	7	15	μs	A
10.4	TXD dominant time-out timer	V <sub>TXD</sub> = 0V		T <sub>dom</sub>	6	10	20	ms	A
10.5	Duty cycle 1	TH <sub>Rec(max)</sub> = 0.744 × V <sub>S</sub> ; TH <sub>Dom(max)</sub> = 0.581 × V <sub>S</sub> ; V <sub>S</sub> = 7.0V to 18V; t <sub>Bit</sub> = 50 μs D1 = t <sub>bus_rec(min)</sub> / (2 × t <sub>Bit</sub> )		D1	0.396				A
10.6	Duty cycle 2	TH <sub>Rec(min)</sub> = 0.422 × V <sub>S</sub> ; TH <sub>Dom(min)</sub> = 0.284 × V <sub>S</sub> ; V <sub>S</sub> = 7.0V to 18V; t <sub>Bit</sub> = 50 μs D2 = t <sub>bus_rec(max)</sub> / (2 × t <sub>Bit</sub> )		D2			0.581		A
10.7	Slope time falling and rising edge at LIN	Slope time dominant and recessive edges		T <sub>SLOPE_fall</sub> T <sub>SLOPE_rise</sub>	3.5		22.5	μs	A
10.8	Time of low pulse for wake-up via pin WAKE	V <sub>WAKE</sub> = 0V		T <sub>WAKE</sub>	60	130	200	μs	A
<b>11</b>	<b>Internal Receiver Electrical AC Parameters of the LIN Physical Layer LIN Receiver, RXD Load Conditions (C<sub>RXD</sub>): 20 pF</b>								
11.1	Propagation delay of receiver (Figure 5-1 on page 22)	t <sub>rec_pd</sub> = max(t <sub>rx_pdr</sub> , t <sub>rx_pdf</sub> )		t <sub>rx_pd</sub>			6	μs	A
11.2	Symmetry of receiver propagation delay rising edge minus falling edge	t <sub>rx_sym</sub> = t <sub>rx_pdr</sub> - t <sub>rx_pdf</sub>		t <sub>rx_sym</sub>	-2		2	μs	A

\*) Type means: A = 100% tested, B = 100% correlation tested, C = Characterized on samples, D = Design parameter

## 5. Electrical Characteristics (Continued)

$5V < V_S < 18V$ ,  $T_{amb} = -40^{\circ}C$  to  $+125^{\circ}C$

No.	Parameters	Test Conditions	Pin	Symbol	Min	Typ	Max	Unit	Type*
<b>12</b>	<b>Watchdog Input PTRIG and NTRIG</b>								
12.1	Watchdog input high-level threshold			$V_{H\_PTRIG}$	3.5			V	A
12.2	Watchdog input low threshold			$V_{L\_PTRIG}$			1.5	V	A
12.3	Internal pull down PTRIG Internal pull down NTRIG			$R_{pd\_PTRIG}$ $R_{pu\_NTRIG}$	250		600	k $\Omega$	A
<b>13</b>	<b>Watchdog Oscillator</b>								
13.1	Voltage at WD_OSC in Normal Mode	$I_{WD\_OSC} = -250 \mu A$		$V_{WD\_OSC}$	2.3	2.5	2.7	V	A
13.2	Possible values of resistor			$R_{OSC}$	10		120	k $\Omega$	D
13.3	Oscillator period	$R_{OSC} = 10 \text{ k}\Omega$		$t_{OSC}$	2.1	2.6	3.1	$\mu s$	A
13.4	Oscillator period	$R_{OSC} = 51 \text{ k}\Omega$		$t_{OSC}$	10	12.5	15	$\mu s$	A
13.5	Oscillator period	$R_{OSC} = 91 \text{ k}\Omega$		$t_{OSC}$	17.9	22.4	26.8	$\mu s$	A
13.6	Oscillator period	$R_{OSC} = 120 \text{ k}\Omega$		$t_{OSC}$	23.2	29	34.8	$\mu s$	A
<b>14</b>	<b>Watchdog Timing Relative to <math>t_{osc}</math></b>								
14.1	Watchdog lead time after reset			$t_d$		3922		cycles	A
14.2	Watchdog closed window			$t_1$		800		cycles	A
14.3	Watchdog open window			$t_2$		840		cycles	A
14.4	Watchdog reset time NRES			$t_{nres}$		157		cycles	A
<b>15</b>	<b>Temperature Monitor at Pin TEMP</b>								
15.1	Voltage at TEMP in Normal Mode (T = $-40^{\circ}C$ )	$I_{TEMP} = \pm 3 \mu A$		$V_{TEMP}$	2.35		2.7	V	A
15.1	Voltage at TEMP in Normal Mode (T = $27^{\circ}C$ )	$I_{TEMP} = \pm 3 \mu A$		$V_{TEMP}$	2.0		2.35	V	A
15.1	Voltage at TEMP in Normal Mode (T = $125^{\circ}C$ )	$I_{TEMP} = \pm 3 \mu A$		$V_{TEMP}$	1.4		1.9	V	A
15.2	Short current at TEMP	$V_{TEMP} = 0V$		$I_{TEMP}$	-30		-15	$\mu A$	A
15.3	Temperature gradient			$V_{TC,TEMP}$	4.8	5.05	5.3	mV/k	C
<b>16</b>	<b>Wake Pin</b>								
16.1	High-level input voltage			$V_{WAKEH}$	$V_S - 1V$		$V_S + 0.3V$	V	A
16.2	Low-level input voltage	Initializes a wake-up signal		$V_{WAKEL}$	-27		$V_S - 3.3V$	V	A
16.3	Wake pull-up current	$V_S < 27V$ , $V_{Wake} = 0V$		$I_{WAKE}$	-30	-10		$\mu A$	A
16.4	High-level leakage current	$V_S = 27V$ ; $V_{Wake} = 27V$		$I_{WAKEL}$	-5		+5	$\mu A$	A

\*) Type means: A = 100% tested, B = 100% correlation tested, C = Characterized on samples, D = Design parameter

## 5. Electrical Characteristics (Continued)

5V < V<sub>S</sub> < 18V, T<sub>amb</sub> = -40°C to +125°C

No.	Parameters	Test Conditions	Pin	Symbol	Min	Typ	Max	Unit	Type*
17	<b>Mode Input Pin</b>								
17.1	Low-level voltage input			V <sub>MODEL</sub>	-0.3		+0.8V	V	A
17.2	High-level voltage input			V <sub>MODEH</sub>	2		V <sub>S</sub> + 0.3V	V	A
17.3	High-level leakage current	V <sub>MODE</sub> = VCC or V <sub>MODE</sub> = 0V		I <sub>MODE</sub>	-3		+3	μA	A

\*) Type means: A = 100% tested, B = 100% correlation tested, C = Characterized on samples, D = Design parameter

**Figure 5-1.** Definition of Bus Timing Parameters

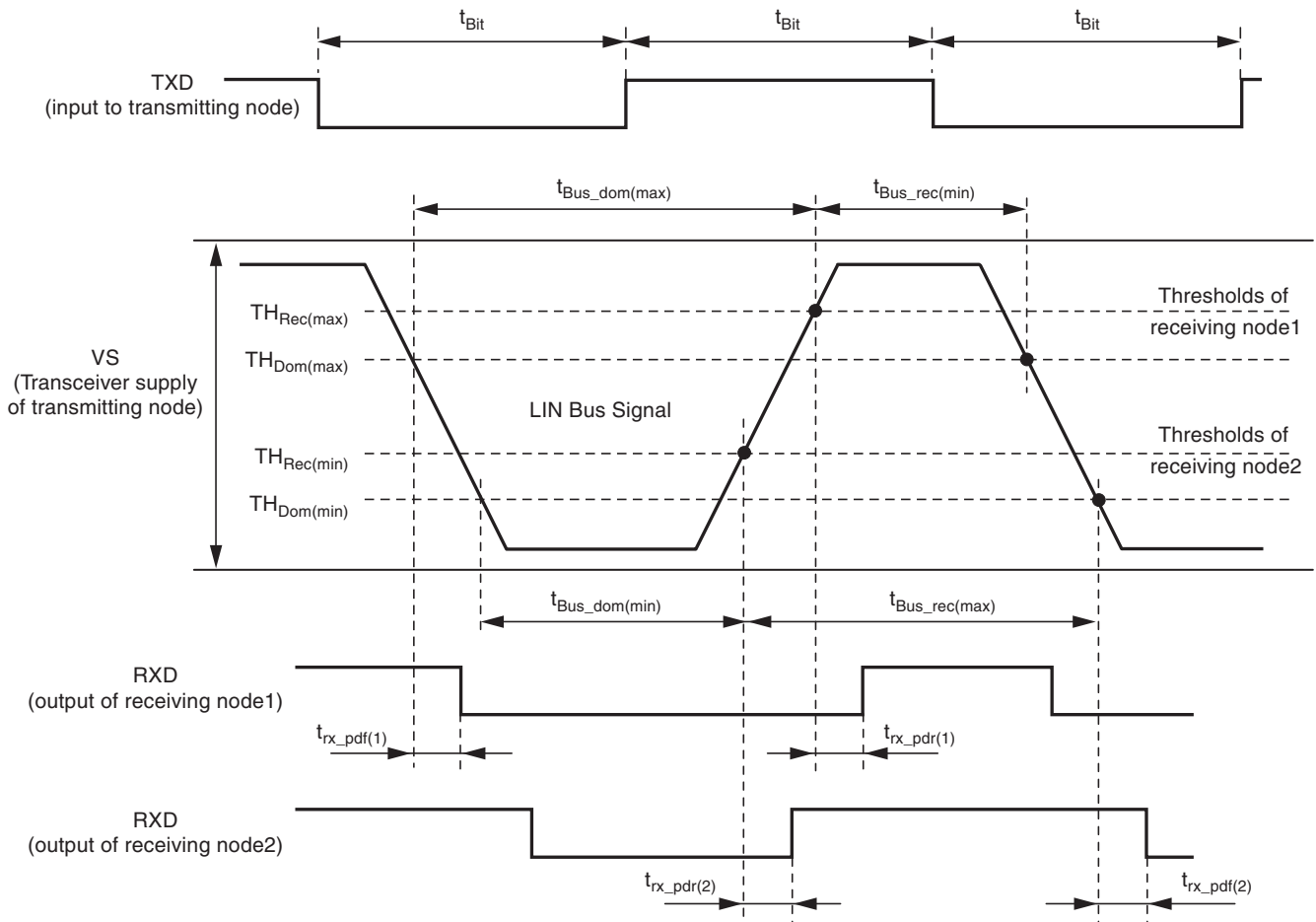
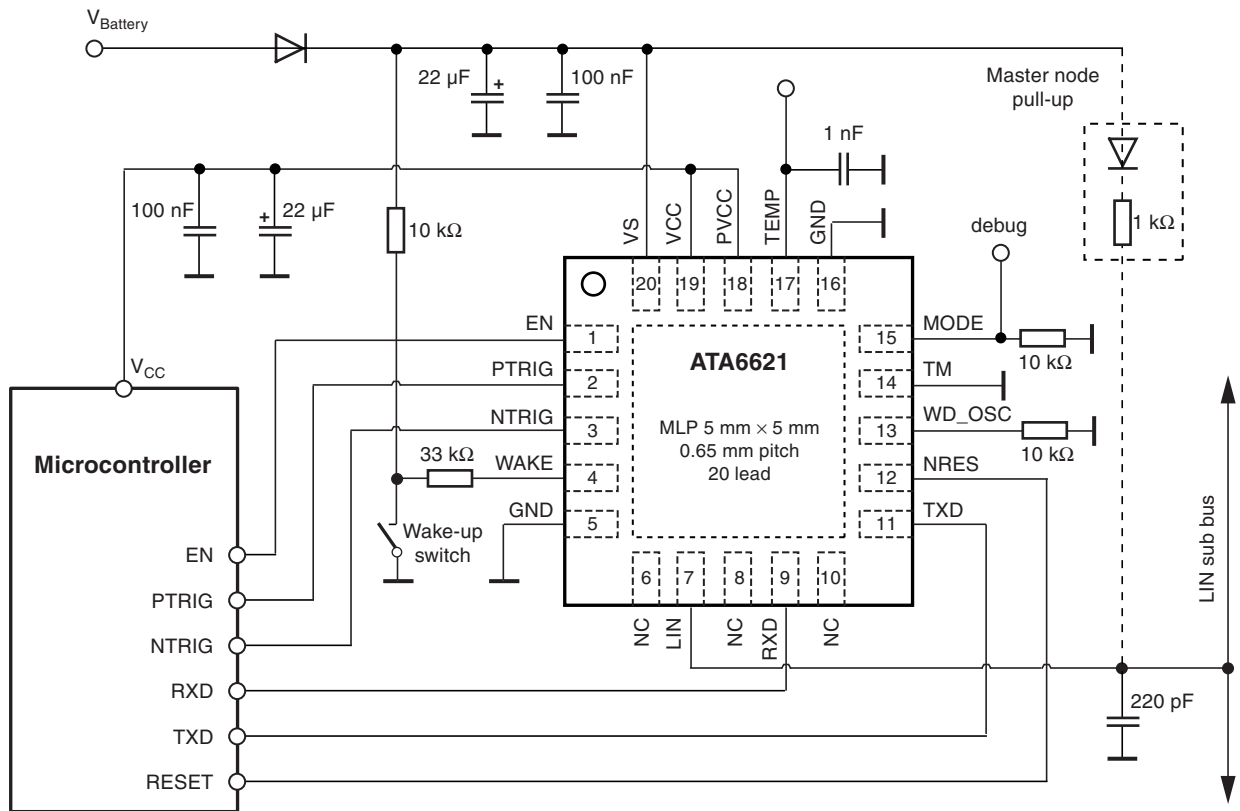

Figure 5-2. Application Circuit







## 6. Ordering Information

Extended Type Number	Package	Remarks
ATA6621-PGQW	QFN20	Pb-free, taped and reeled
ATA6621-PGPW	QFN20	Pb-free, taped and reeled

## 7. Package Information

Package: QFN 20LD 5x5

Exposed pad 3.1 x 3.1

Dimensions in mm

Not indicated tolerances  $\pm 0.05$

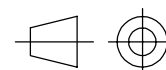
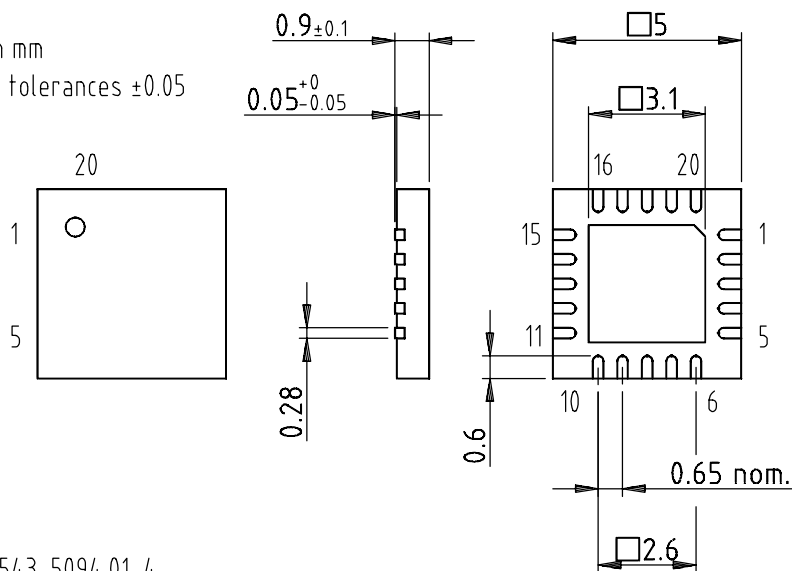

technical drawings  
according to DIN  
specifications

Drawing-No.: 6.543-5094.01-4

Issue: 1; 19.12.02

## 8. Revision History

Please note that the following page numbers referred to in this section refer to the specific revision mentioned, not to this document.

Revision No.	History
4887D-AUTO-12/06	<ul style="list-style-type: none"> <li>• Put datasheet in a new template</li> <li>• Table 2-1 “Pin Description” on page 3 changed</li> <li>• Section 3.1 “Supply Pin (VS)” on page 4 changed</li> <li>• Section 3.7 “TXD Dominant Time-out Function” on page 5 changed</li> <li>• Section 3.13.3 “Sleep Mode” on page 8 changed</li> <li>• Section 3.14 in “Wake-up Scenarios from Silent or Sleep Mode” renamed</li> <li>• Section 3.15 “Fail-safe Features” on page 11 changed</li> <li>• Section 3.18 “Temperature Monitor at Pin TEMP” changed</li> <li>• Table “Electrical Characteristics” numbers 10.4, 13.2 and 15.3 on pages 20 to 21 changed</li> <li>• Table “Electrical Characteristics” numbers 17.1, 17.2 and 17.3 on page 22 added</li> <li>• Section 6 “Ordering Information” on page 25 changed</li> </ul>
4887C-AUTO-03/06	<ul style="list-style-type: none"> <li>• Features on page 1 changed</li> <li>• Table 2-1 “Pin Description” on page 3 changed</li> <li>• Section 3.11 “Mode and TM Input Pins” on page 5 changed</li> <li>• Figure 3-1 “Modes of Operation” on page 6 changed</li> <li>• Section 3.12.6 “Debug Mode” on page 9 added</li> <li>• Section 3.13.3 “Wake-up Source Recognition” on page 11 changed</li> <li>• Section 3.15 “Voltage Regulator” on page 12 changed</li> <li>• Table “Absolute Maximum Ratings” on page 16 changed</li> <li>• Table “Electrical Characteristics” from pages 17 to 21 changed</li> <li>• Figure 5-2 “Application Circuit” on page 23 changed</li> <li>• Figure 5-3 “Application Circuit with External NPN” on page 24 changed</li> </ul>



## Atmel Corporation

2325 Orchard Parkway  
San Jose, CA 95131, USA  
Tel: 1(408) 441-0311  
Fax: 1(408) 487-2600

## Regional Headquarters

### Europe

Atmel Sarl  
Route des Arsenaux 41  
Case Postale 80  
CH-1705 Fribourg  
Switzerland  
Tel: (41) 26-426-5555  
Fax: (41) 26-426-5500

### Asia

Room 1219  
Chinachem Golden Plaza  
77 Mody Road Tsimshatsui  
East Kowloon  
Hong Kong  
Tel: (852) 2721-9778  
Fax: (852) 2722-1369

### Japan

9F, Tonetsu Shinkawa Bldg.  
1-24-8 Shinkawa  
Chuo-ku, Tokyo 104-0033  
Japan  
Tel: (81) 3-3523-3551  
Fax: (81) 3-3523-7581

## Atmel Operations

### Memory

2325 Orchard Parkway  
San Jose, CA 95131, USA  
Tel: 1(408) 441-0311  
Fax: 1(408) 436-4314

### Microcontrollers

2325 Orchard Parkway  
San Jose, CA 95131, USA  
Tel: 1(408) 441-0311  
Fax: 1(408) 436-4314

La Chantrerie  
BP 70602  
44306 Nantes Cedex 3, France  
Tel: (33) 2-40-18-18-18  
Fax: (33) 2-40-18-19-60

### ASIC/ASSP/Smart Cards

Zone Industrielle  
13106 Rousset Cedex, France  
Tel: (33) 4-42-53-60-00  
Fax: (33) 4-42-53-60-01

1150 East Cheyenne Mtn. Blvd.  
Colorado Springs, CO 80906, USA  
Tel: 1(719) 576-3300  
Fax: 1(719) 540-1759

Scottish Enterprise Technology Park  
Maxwell Building  
East Kilbride G75 0QR, Scotland  
Tel: (44) 1355-803-000  
Fax: (44) 1355-242-743

### RF/Automotive

Theresienstrasse 2  
Postfach 3535  
74025 Heilbronn, Germany  
Tel: (49) 71-31-67-0  
Fax: (49) 71-31-67-2340

1150 East Cheyenne Mtn. Blvd.  
Colorado Springs, CO 80906, USA  
Tel: 1(719) 576-3300  
Fax: 1(719) 540-1759

### Biometrics

Avenue de Rochepleine  
BP 123  
38521 Saint-Egreve Cedex, France  
Tel: (33) 4-76-58-47-50  
Fax: (33) 4-76-58-47-60

---

## Literature Requests

[www.atmel.com/literature](http://www.atmel.com/literature)

**Disclaimer:** The information in this document is provided in connection with Atmel products. No license, express or implied, by estoppel or otherwise, to any intellectual property right is granted by this document or in connection with the sale of Atmel products. **EXCEPT AS SET FORTH IN ATMEL'S TERMS AND CONDITIONS OF SALE LOCATED ON ATMEL'S WEB SITE, ATMEL ASSUMES NO LIABILITY WHATSOEVER AND DISCLAIMS ANY EXPRESS, IMPLIED OR STATUTORY WARRANTY RELATING TO ITS PRODUCTS INCLUDING, BUT NOT LIMITED TO, THE IMPLIED WARRANTY OF MERCHANTABILITY, FITNESS FOR A PARTICULAR PURPOSE, OR NON-INFRINGEMENT. IN NO EVENT SHALL ATMEL BE LIABLE FOR ANY DIRECT, INDIRECT, CONSEQUENTIAL, PUNITIVE, SPECIAL OR INCIDENTAL DAMAGES (INCLUDING, WITHOUT LIMITATION, DAMAGES FOR LOSS OF PROFITS, BUSINESS INTERRUPTION, OR LOSS OF INFORMATION) ARISING OUT OF THE USE OR INABILITY TO USE THIS DOCUMENT, EVEN IF ATMEL HAS BEEN ADVISED OF THE POSSIBILITY OF SUCH DAMAGES.** Atmel makes no representations or warranties with respect to the accuracy or completeness of the contents of this document and reserves the right to make changes to specifications and product descriptions at any time without notice. Atmel does not make any commitment to update the information contained herein. Unless specifically provided otherwise, Atmel products are not suitable for, and shall not be used in, automotive applications. Atmel's products are not intended, authorized, or warranted for use as components in applications intended to support or sustain life.

© 2006 Atmel Corporation. All rights reserved. Atmel®, logo and combinations thereof, Everywhere You Are® and others are registered trademarks or trademarks of Atmel Corporation or its subsidiaries. Other terms and product names may be trademarks of others.