

# ATF-33143

## Low Noise Pseudomorphic HEMT in a Surface Mount Plastic Package



### Data Sheet

#### Description

Avago's ATF-33143 is a high dynamic range, low noise PHEMT housed in a 4-lead SC-70 (SOT-343) surface mount plastic package.

Based on its featured performance, ATF-33143 is ideal for the first or second stage of base station LNA due to the excellent combination of low noise figure and enhanced linearity<sup>[1]</sup>. The device is also suitable for applications in Wireless LAN, WLL/RLL, MMDS, and other systems requiring super low noise figure with good intercept in the 450 MHz to 10 GHz frequency range.

Note:

1. From the same PHEMT FET family, the smaller geometry ATF-34143 may also be considered for the higher gain performance, particularly in the higher frequency band (1.8 GHz and up).

#### Surface Mount Package SOT-343

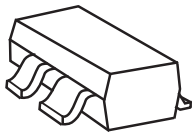

#### Pin Connections and Package Marking

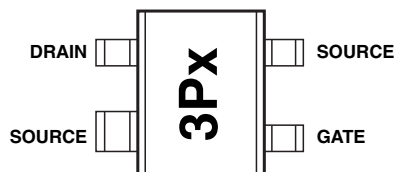

Note:

Top View. Package marking provides orientation and identification.

"3P" = Device code

"x" = Date code character. A new character is assigned for each month, year.

#### Features

- Lead-free Option Available
- Low Noise Figure
- Excellent Uniformity in Product Specifications
- 1600 micron Gate Width
- Low Cost Surface Mount Small Plastic Package SOT-343 (4 lead SC-70)
- Tape-and-Reel Packaging Option Available

#### Specifications

##### 1.9 GHz; 4V, 80 mA (Typ.)

- 0.5 dB Noise Figure
- 15 dB Associated Gain
- 22 dBm Output Power at 1 dB Gain Compression
- 33.5 dBm Output 3<sup>rd</sup> Order Intercept

#### Applications

- Tower Mounted Amplifier, Low Noise Amplifier and Driver Amplifier for GSM/TDMA/CDMA Base Stations
- LNA for Wireless LAN, WLL/RLL and MMDS Applications
- General Purpose Discrete PHEMT for other Ultra Low Noise Applications



**Attention: Observe precautions for handling electrostatic sensitive devices.**

ESD Machine Model (Class A)

ESD Human Body Model (Class 0)

Refer to Avago Application Note A004R:

Electrostatic Discharge Damage and Control.

## ATF-33143 Absolute Maximum Ratings<sup>[1]</sup>

Symbol	Parameter	Units	Absolute Maximum
$V_{DS}$	Drain - Source Voltage <sup>[2]</sup>	V	5.5
$V_{GS}$	Gate - Source Voltage <sup>[2]</sup>	V	-5
$V_{GD}$	Gate Drain Voltage <sup>[2]</sup>	V	-5
$I_{DS}$	Drain Current <sup>[2]</sup>	mA	$I_{dss}$ <sup>[3]</sup>
$P_{diss}$	Total Power Dissipation <sup>[4]</sup>	mW	600
$P_{in\ max}$	RF Input Power	dBm	20
$T_{CH}$	Channel Temperature <sup>[5]</sup>	°C	160
$T_{STG}$	Storage Temperature	°C	-65 to 160
$\theta_{JC}$	Thermal Resistance <sup>[6]</sup>	°C/W	145

### Notes:

1. Operation of this device above any one of these parameters may cause permanent damage.
2. Assumes DC quiescent conditions.
3.  $V_{GS} = 0V$
4. Source lead temperature is 25°C. Derate 6 mW/°C for  $T_L > 60^\circ C$ .
5. Please refer to failure rates in reliability section to assess the reliability impact of running devices above a channel temperature of 140°C.
6. Thermal resistance measured using 150°C Liquid Crystal Measurement method.

## Product Consistency Distribution Charts<sup>[8, 9]</sup>

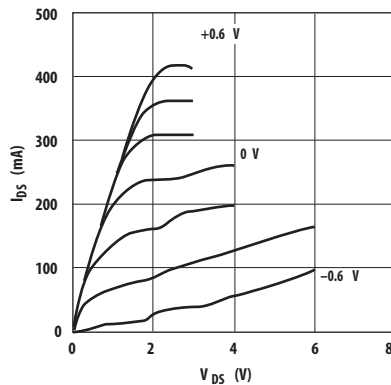

Figure 1. Typical Pulsed I-V Curves<sup>[7]</sup>. ( $V_{GS} = -0.2V$  per step)

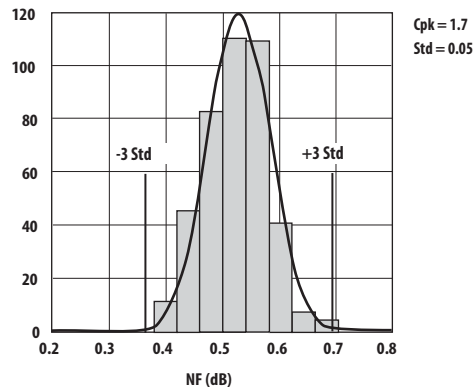

Figure 2. NF @ 2 GHz, 4 V, 80 mA.  
LSL=0.2, Nominal=0.53, USL=0.8

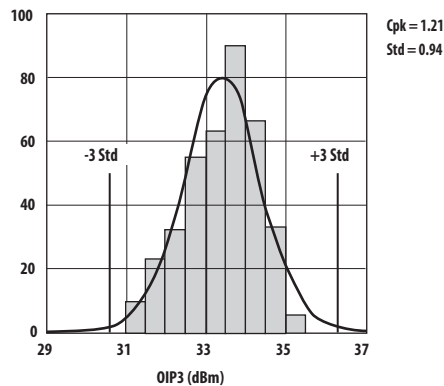

Figure 3. OIP3 @ 2 GHz, 4 V, 80 mA.  
LSL=30.0, Nominal=33.3, USL=37.0

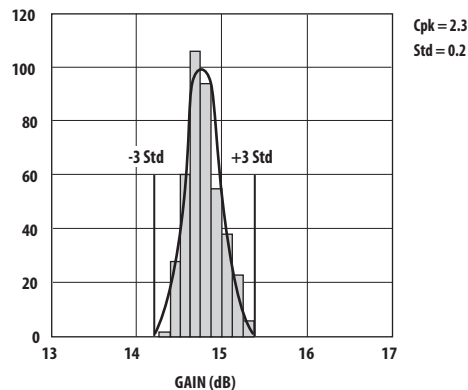

Figure 4. Gain @ 2 GHz, 4 V, 80 mA.  
LSL=13.5, Nominal=14.8, USL=16.5

### Notes:

7. Under large signal conditions,  $V_{GS}$  may swing positive and the drain current may exceed  $I_{dss}$ . These conditions are acceptable as long as the maximum  $P_{diss}$  and  $P_{in\ max}$  ratings are not exceeded.
8. Distribution data sample size is 450 samples taken from 9 different wafers. Future wafers allocated to this product may have nominal values anywhere within the upper and lower spec limits.
9. Measurements made on production test board. This circuit represents a trade-off between an optimal noise match and a realizable match based on production test requirements. Circuit losses have been de-embedded from actual measurements.
10. The probability of a parameter being between  $\pm 1\sigma$  is 68.3%, between  $\pm 2\sigma$  is 95.4% and between  $\pm 3\sigma$  is 99.7%.

**ATF-33143 DC Electrical Specifications**  $T_A = 25^\circ\text{C}$ , RF parameters measured in a test circuit for a typical device

Symbol	Parameters and Test Conditions	Units	Min.	Typ. <sup>[2]</sup>	Max.
$I_{dss}^{[1]}$	Saturated Drain Current $V_{DS} = 1.5\text{ V}, V_{GS} = 0\text{ V}$	mA	175	237	305
$V_p^{[1]}$	Pinchoff Voltage $V_{DS} = 1.5\text{ V}, I_{DS} = 10\% \text{ of } I_{dss}$	V	-0.65	-0.5	-0.35
$I_d$	Quiescent Bias Current $V_{GS} = -0.5\text{ V}, V_{DS} = 4\text{ V}$	mA	—	80	—
$g_m^{[1]}$	Transconductance $V_{DS} = 1.5\text{ V}, g_m = I_{dss}/V_p$	mmho	360	440	—
$I_{GDO}$	Gate to Drain Leakage Current $V_{GD} = 5\text{ V}$	$\mu\text{A}$	—	—	1000
$I_{gss}$	Gate Leakage Current $V_{GD} = V_{GS} = -4\text{ V}$	$\mu\text{A}$	—	42	600
NF	Noise Figure	$f = 2\text{ GHz}$ $V_{DS} = 4\text{ V}, I_{DS} = 80\text{ mA}$	dB	0.5	0.8
		$V_{DS} = 4\text{ V}, I_{DS} = 60\text{ mA}$		0.5	
		$f = 900\text{ MHz}$ $V_{DS} = 4\text{ V}, I_{DS} = 80\text{ mA}$	dB	0.4	
		$V_{DS} = 4\text{ V}, I_{DS} = 60\text{ mA}$		0.4	
$G_a$	Associated Gain <sup>[3]</sup>	$f = 2\text{ GHz}$ $V_{DS} = 4\text{ V}, I_{DS} = 80\text{ mA}$	dB	13.5	15
		$V_{DS} = 4\text{ V}, I_{DS} = 60\text{ mA}$		15	16.5
		$f = 900\text{ MHz}$ $V_{DS} = 4\text{ V}, I_{DS} = 80\text{ mA}$	dB	21	
		$V_{DS} = 4\text{ V}, I_{DS} = 60\text{ mA}$		21	
OIP3	Output 3 <sup>rd</sup> Order Intercept Point <sup>[3]</sup>	$f = 2\text{ GHz}$ 5 dBm Pout/Tone $V_{DS} = 4\text{ V}, I_{DS} = 80\text{ mA}$	dBm	30	33.5
		$V_{DS} = 4\text{ V}, I_{DS} = 60\text{ mA}$		32	
		$f = 900\text{ MHz}$ 5 dBm Pout/Tone $V_{DS} = 4\text{ V}, I_{DS} = 80\text{ mA}$	dBm	32.5	
		$V_{DS} = 4\text{ V}, I_{DS} = 60\text{ mA}$		31	
$P_{1dB}$	1 dB Compressed Compressed Power <sup>[3]</sup>	$f = 2\text{ GHz}$ $V_{DS} = 4\text{ V}, I_{DS} = 80\text{ mA}$	dBm	22	
		$V_{DS} = 4\text{ V}, I_{DS} = 60\text{ mA}$		21	
		$f = 900\text{ MHz}$ $V_{DS} = 4\text{ V}, I_{DS} = 80\text{ mA}$	dBm	21	
		$V_{DS} = 4\text{ V}, I_{DS} = 60\text{ mA}$		20	

Notes:

1. Guaranteed at wafer probe level.
2. Typical value determined from a sample size of 450 parts from 9 wafers.
3. Measurements obtained using production test board described in Figure 5.

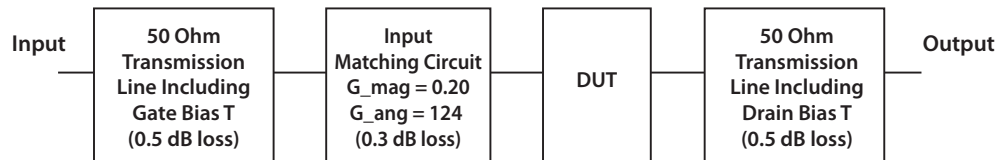

**Figure 5. Block diagram of 2 GHz production test board used for Noise Figure, Associated Gain, P1dB, and OIP3 measurements. This circuit represents a trade-off between an optimal noise match and a realizable match based on production test requirements. Circuit losses have been de-embedded from actual measurements.**

# ATF-33143 Typical Performance Curves

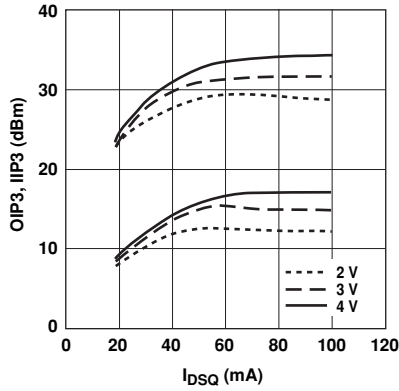

Figure 6. OIP3, IIP3 vs. Bias<sup>[1]</sup> at 2 GHz.

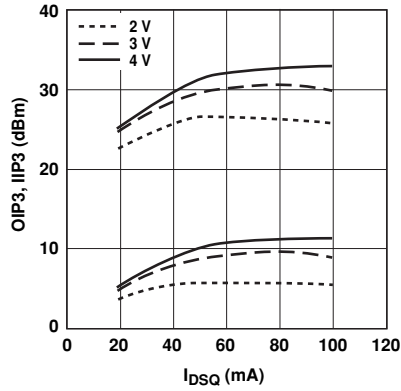

Figure 7. OIP3, IIP3 vs. Bias<sup>[1]</sup> at 900 MHz.

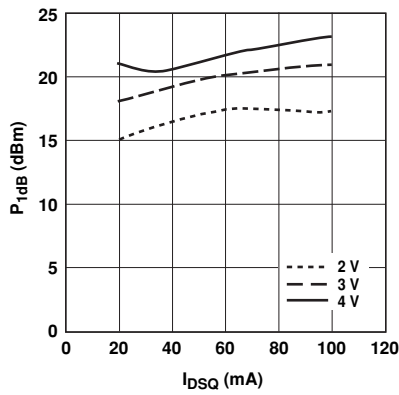

Figure 8. P<sub>1dB</sub> vs. Bias<sup>[1,2]</sup> at 2 GHz.

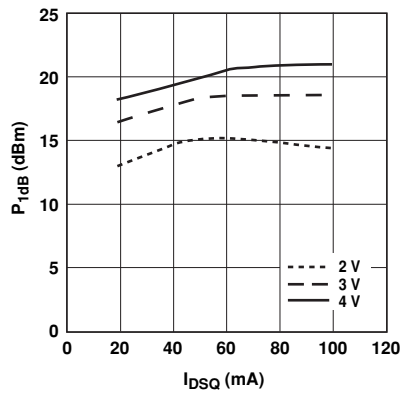

Figure 9. P<sub>1dB</sub> vs. Bias<sup>[1,2]</sup> Tuned for NF @ 4V, 80 mA at 900 MHz.

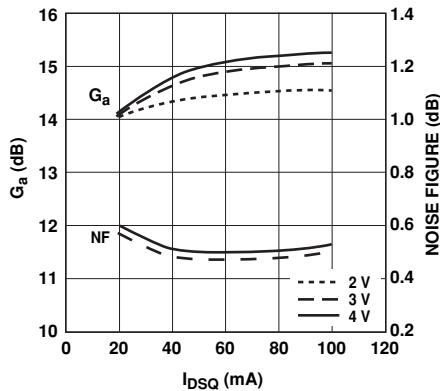

Figure 10. NF and G<sub>a</sub> vs. Bias<sup>[1]</sup> at 2 GHz.

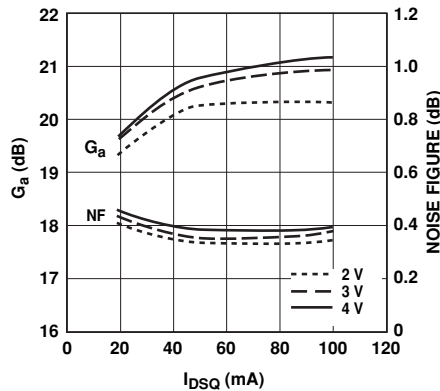

Figure 11. NF and G<sub>a</sub> vs. Bias<sup>[1]</sup> at 900 MHz.

Notes:

1. Measurements made on a fixed tuned production test board that was tuned for optimal gain match with reasonable noise figure at 4V 80 mA bias. This circuit represents a trade-off between optimal noise match, maximum gain match and a realizable match based on production test board requirements. Circuit losses have been de-embedded from actual measurements.
2. Quiescent drain current,  $I_{DSQ}$ , is set with zero RF drive applied. As  $P_{1dB}$  is approached, the drain current may increase or decrease depending on frequency and dc bias point. At lower values of  $I_{DSQ}$  the device is running closer to class B as power output approaches  $P_{1dB}$ . This results in higher  $P_{1dB}$  and higher PAE (power added efficiency) when compared to a device that is driven by a constant current source as is typically done with active biasing.

## ATF-33143 Typical Performance Curves, continued

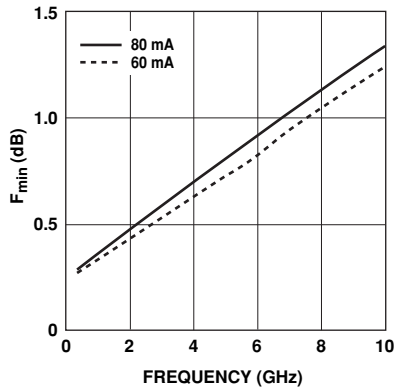

Figure 12.  $F_{min}$  vs. Frequency and Current at 4V.

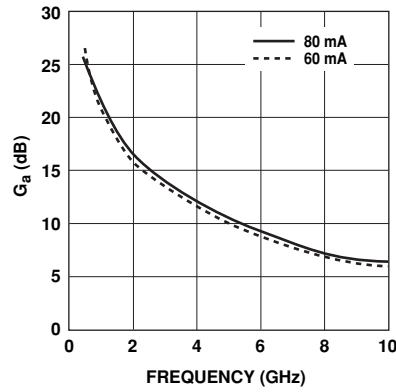

Figure 13. Associated Gain vs. Frequency and Current at 4V.

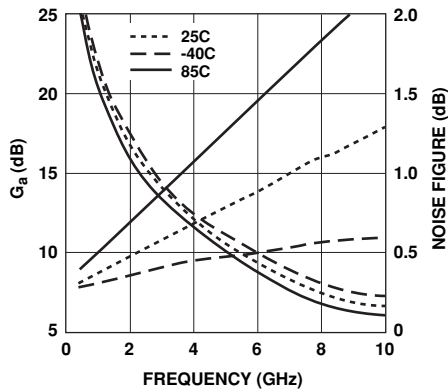

Figure 14.  $F_{min}$  and  $G_a$  vs. Frequency and Temp at  $V_{DS} = 4V$ ,  $I_{DS} = 80 mA$ .

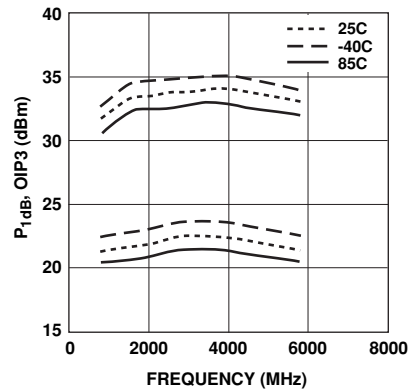

Figure 15.  $P_{1dB}$ , OIP3 vs. Frequency and Temp at  $V_{DS} = 4V$ ,  $I_{DS} = 80 mA$ .

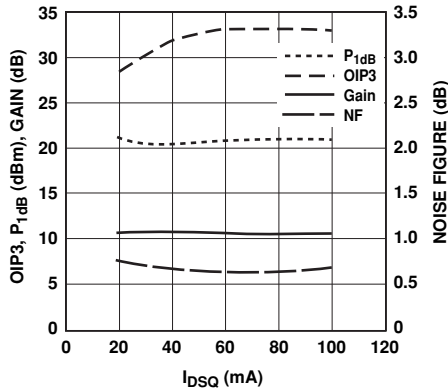

Figure 16. OIP3,  $P_{1dB}$ , NF and Gain vs. Bias<sup>[1,2]</sup> at 3.9 GHz.

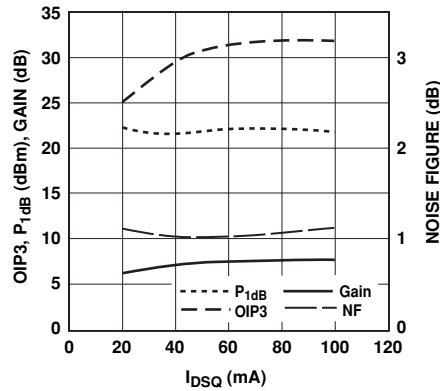

Figure 17. OIP3,  $P_{1dB}$ , NF and Gain vs. Bias<sup>[1,2]</sup> at 5.8 GHz.

### Notes:

1. Measurements made on a fixed tuned test fixture that was tuned for noise figure at 4V 80 mA bias. This circuit represents a trade-off between optimal noise match, maximum gain match and a realizable match based on production test requirements. Circuit losses have been de-embedded from actual measurements.
2. Quiescent drain current,  $I_{DSQ}$ , is set with zero RF drive applied. As  $P_{1dB}$  is approached, the drain current may increase or decrease depending on frequency and dc bias point. At lower values of  $I_{DSQ}$  the device is running closer to class B as power output approaches  $P_{1dB}$ . This results in higher  $P_{1dB}$  and higher PAE (power added efficiency) when compared to a device that is driven by a constant current source as is typically done with active biasing.

## ATF-33143 Typical Performance Curves, continued

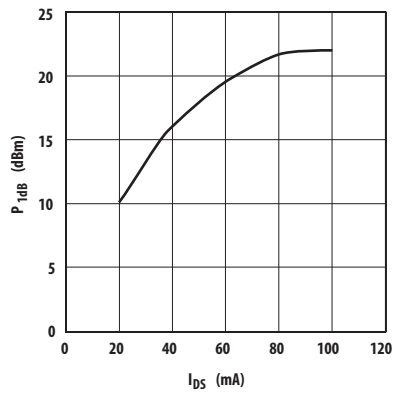

Figure 18.  $P_{1dB}$  vs.  $I_{D5}$  Active Bias<sup>[1]</sup> Tuned for NF @ 4V, 80 mA at 2 GHz.

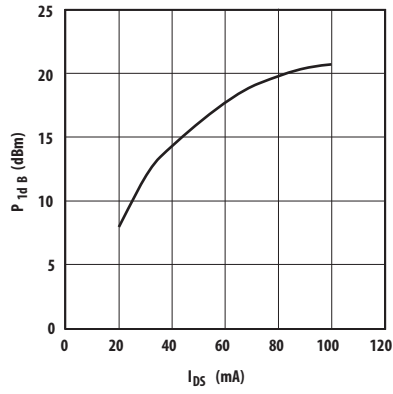

Figure 19.  $P_{1dB}$  vs.  $I_{D5}$  Active Bias<sup>[1]</sup> Tuned for NF @ 4V, 80 mA at 900 MHz.

### Note:

1. Measurements made on a fixed tuned test board that was tuned for optimal gain match with reasonable noise figure at 4V 80 mA bias. This circuit represents a trade-off between an optimal noise match, maximum gain match and a realizable match based on production test board requirements. Circuit losses have been de-embedded from actual measurements.

### ATF-33143 Power Parameters Tuned for Max $P_{1dB}$ , $V_{DS} = 4\text{ V}$ , $I_{DSQ} = 80\text{ mA}$

Freq (GHz)	$P_{1dB}$ (dBm)	$I_d$ (mA)	$G_{1dB}$ (dB)	$PAE_{1dB}$ (%)	$P_{3dB}$ (dBm)	$I_d$ (mA)	$PAE_{3dB}$ (%)	$\Gamma_{\text{Out\_mag}}$ (Mag.)	$\Gamma_{\text{Out\_ang}}$ (°)
0.9	20.7	89	23.2	33	23.2	102	51	0.39	160
1.5	21.2	91	20.7	36	23.8	116	51	0.43	165
1.8	21.1	80	19.2	40	23.0	94	52	0.43	170
2.0	21.6	81	18.1	44	23.2	89	57	0.42	174
4.0	23.0	97	11.9	48	24.6	135	48	0.40	-150
6.0	24.0	130	5.9	36	25.2	136	36	0.37	-124

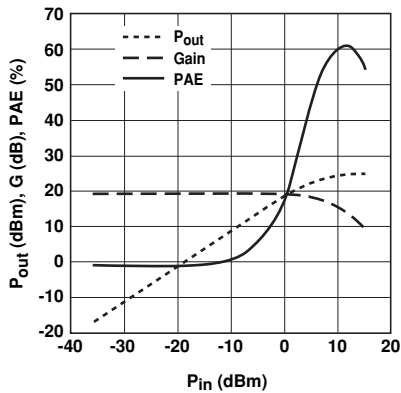

**Figure 20. Swept Power Tuned for Max  $P_{1dB}$**   
 $V_{DS} = 4\text{ V}$ ,  $I_{DSQ} = 80\text{ mA}$ , 2 GHz.

#### Notes:

1. Measurements made on ATN LP1 power load pull system.
2. Quiescent drain current,  $I_{DSQ}$ , is set with zero RF drive applied. As  $P_{1dB}$  is approached, the drain current may increase or decrease depending on frequency and dc bias point. At lower values of  $I_{DSQ}$  the device is running closer to class B as power output approaches  $P_{1dB}$ . This results in higher  $P_{1dB}$  and higher PAE (power added efficiency) when compared to a device that is driven by a constant current source as is typically done with active biasing.
3.  $PAE (\%) = ((P_{out} - P_{in}) / P_{dc}) \times 100$
4. Gamma out is the reflection coefficient of the matching circuit presented to the output of the device.

**ATF-33143 Typical Scattering Parameters,  $V_{DS} = 2V, I_{DS} = 40\text{ mA}$**

Freq. (GHz)	$S_{11}$		$S_{21}$			$S_{12}$		$S_{22}$		MSG/MAG (dB)	
	Mag.	Ang.	dB	Mag.	Ang.	dB	Mag.	Ang.	Mag.		Ang.
0.5	0.88	-72.70	22.08	12.81	134.40	-27.02	0.045	54.50	0.28	-118.70	24.54
0.8	0.79	-112.10	19.46	9.41	111.20	-24.13	0.062	40.70	0.37	-149.90	21.81
1.0	0.78	-119.80	18.86	8.86	106.50	-23.93	0.064	38.00	0.38	-155.40	21.41
1.5	0.75	-149.60	16.11	6.44	88.30	-22.57	0.075	29.80	0.42	-176.20	19.34
1.8	0.74	-162.80	14.70	5.47	79.80	-22.14	0.079	26.80	0.45	-174.70	18.40
2.0	0.74	-170.10	13.84	4.94	74.80	-21.84	0.082	24.90	0.46	-169.40	17.80
2.5	0.74	172.30	11.98	3.98	63.00	-21.24	0.088	20.80	0.49	160.10	16.56
3.0	0.75	159.10	10.37	3.31	53.10	-20.68	0.094	17.10	0.51	152.10	15.46
4.0	0.75	137.00	7.95	2.50	35.00	-19.59	0.106	9.30	0.53	139.20	13.73
5.0	0.76	117.20	6.20	2.05	17.20	-18.56	0.119	-0.70	0.54	124.70	11.44
6.0	0.78	98.10	4.69	1.73	-1.30	-17.83	0.129	-12.80	0.54	108.00	9.80
7.0	0.80	80.10	3.12	1.44	-19.30	-17.42	0.135	-26.00	0.57	90.40	8.35
8.0	0.83	64.50	1.68	1.22	-35.20	-17.29	0.137	-37.30	0.60	74.80	7.43
9.0	0.83	50.30	0.48	1.07	-49.30	-17.08	0.140	-46.80	0.63	62.70	6.45
10.0	0.86	36.30	-0.46	0.96	-64.30	-16.59	0.148	-58.30	0.65	50.90	6.41
11.0	0.88	21.50	-1.50	0.85	-80.20	-16.53	0.149	-71.30	0.68	37.40	6.14
12.0	0.90	7.20	-2.70	0.74	-95.80	-16.81	0.144	-83.90	0.72	21.40	5.64
13.0	0.91	-5.00	-4.24	0.62	-110.20	-17.38	0.135	-95.60	0.75	5.80	4.60
14.0	0.91	-15.50	-5.49	0.54	-121.90	-17.78	0.129	-103.90	0.77	-5.70	3.64
15.0	0.92	-27.50	-6.42	0.49	-134.20	-18.00	0.126	-113.70	0.80	-15.80	3.44
16.0	0.93	-40.50	-7.26	0.44	-146.80	-17.87	0.128	-124.20	0.82	-25.70	3.22
17.0	0.94	-52.30	-8.20	0.40	-160.40	-18.07	0.125	-136.40	0.83	-37.90	3.11
18.0	0.93	-61.20	-9.51	0.34	-171.00	-18.79	0.115	-145.10	0.85	-49.70	1.79

**ATF-33143 Typical Noise Parameters**

$V_{DS} = 2V, I_{DS} = 40\text{ mA}$

Freq. GHz	$F_{min}$ dB	$\Gamma_{opt}$		$R_{n/50}$ -	$G_a$ dB
		Mag.	Ang.		
0.5	0.26	0.45	26.00	0.07	24.74
0.9	0.30	0.38	42.20	0.07	21.02
1.0	0.31	0.36	44.80	0.07	20.36
1.5	0.34	0.31	69.50	0.06	17.40
1.8	0.34	0.26	93.60	0.04	16.50
2.0	0.39	0.27	108.60	0.05	15.82
2.5	0.51	0.28	150.70	0.03	14.59
3.0	0.53	0.32	165.60	0.03	13.13
4.0	0.61	0.41	-162.10	0.04	11.27
5.0	0.70	0.49	-136.80	0.06	9.92
6.0	0.82	0.53	-113.60	0.11	8.70
7.0	0.93	0.59	-91.50	0.23	7.71
8.0	1.04	0.62	-72.60	0.38	6.69
9.0	1.12	0.67	-55.90	0.59	6.04
10.0	1.21	0.69	-42.20	0.77	5.73

Notes:

1. The  $F_{min}$  values are based on a set of 16 noise figure measurements made at 16 different impedances using an ATF NP5 test system. From these measurements a true  $F_{min}$  is calculated. Refer to the noise parameter application section for more information.
2. S and noise parameters are measured on a microstrip line made on 0.025 inch thick alumina carrier. The input reference plane is at the end of the gate lead. The output reference plane is at the end of the drain lead. The parameters include the effect of four plated through via holes connecting source landing pads on top of the test carrier to the microstrip ground plane on the bottom side of the carrier. Two 0.020 inch diameter via holes are placed within 0.010 inch from each source lead contact point, one via on each side of that point.

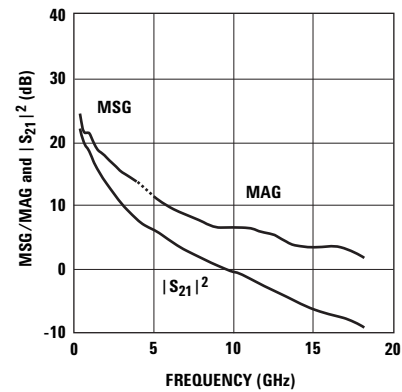

Figure 21. MSG/MAG and  $|S_{21}|^2$  vs. Frequency at 2V, 40 mA.



### ATF-33143 Typical Scattering Parameters, $V_{DS} = 3\text{ V}$ , $I_{DS} = 40\text{ mA}$

Freq. (GHz)	$S_{11}$			$S_{21}$			$S_{12}$		$S_{22}$		MSG/MAG (dB)
	Mag.	Ang.	dB	Mag.	Ang.	dB	Mag.	Ang.	Mag.	Ang.	
0.5	0.87	-72.20	22.51	13.42	134.40	-27.20	0.044	54.40	0.27	-109.80	24.84
0.8	0.78	-111.60	19.88	9.87	111.20	-24.27	0.061	40.60	0.35	-143.70	22.09
1.0	0.77	-119.30	19.28	9.26	106.50	-24.06	0.063	37.90	0.36	-150.10	21.67
1.5	0.74	-149.00	16.52	6.73	88.30	-22.79	0.073	29.80	0.40	-172.10	19.64
1.8	0.73	-162.20	15.11	5.72	79.90	-22.34	0.077	26.90	0.42	-178.40	18.71
2.0	0.73	-169.50	14.24	5.17	74.80	-22.13	0.079	25.00	0.43	-172.90	18.16
2.5	0.73	172.90	12.38	4.17	63.10	-21.41	0.086	21.10	0.46	163.10	16.85
3.0	0.74	159.70	10.78	3.46	53.30	-20.91	0.091	17.50	0.48	154.80	15.80
4.0	0.74	137.60	8.37	2.62	35.20	-19.79	0.103	10.00	0.50	141.20	14.06
5.0	0.75	117.70	6.63	2.15	17.30	-18.80	0.115	0.00	0.51	126.50	11.53
6.0	0.77	98.60	5.10	1.80	-1.30	-17.99	0.126	-11.90	0.52	109.80	9.99
7.0	0.79	80.60	3.54	1.51	-19.50	-17.58	0.132	-24.90	0.55	92.10	8.57
8.0	0.82	64.90	2.10	1.28	-35.50	-17.44	0.134	-36.00	0.57	76.20	7.64
9.0	0.83	50.70	0.92	1.12	-49.60	-17.13	0.139	-45.50	0.60	64.00	6.69
10.0	0.86	36.60	-0.04	1.00	-64.90	-16.64	0.147	-57.00	0.63	52.10	6.65
11.0	0.88	21.90	-1.11	0.89	-81.00	-16.58	0.148	-70.10	0.66	38.60	6.38
12.0	0.90	7.50	-2.32	0.77	-96.80	-16.81	0.144	-82.70	0.70	22.60	6.00
13.0	0.91	-4.80	-3.86	0.64	-111.40	-17.38	0.135	-94.40	0.73	6.80	4.90
14.0	0.91	-15.40	-5.11	0.56	-123.30	-17.78	0.129	-103.00	0.76	-5.00	3.90
15.0	0.92	-27.40	-6.05	0.50	-135.90	-17.93	0.127	-112.80	0.79	-15.10	3.71
16.0	0.93	-40.40	-6.95	0.45	-148.70	-17.87	0.128	-123.40	0.81	-25.10	3.48
17.0	0.94	-52.30	-7.91	0.41	-162.30	-18.00	0.126	-135.70	0.82	-37.30	3.41
18.0	0.93	-61.30	-9.25	0.35	-172.90	-18.72	0.116	-144.30	0.84	-49.10	1.94

### ATF-33143 Typical Noise Parameters

$V_{DS} = 3\text{ V}$ ,  $I_{DS} = 40\text{ mA}$

Freq. GHz	$F_{min}$ dB	$\Gamma_{opt}$		$R_{n/50}$ -	$G_a$ dB
		Mag.	Ang.		
0.5	0.24	0.45	28.40	0.07	25.26
0.9	0.29	0.38	40.90	0.07	21.26
1.0	0.31	0.34	42.60	0.07	20.50
1.5	0.37	0.28	66.30	0.07	17.67
1.8	0.34	0.25	90.10	0.05	16.57
2.0	0.38	0.25	105.80	0.05	15.93
2.5	0.51	0.28	147.40	0.03	14.72
3.0	0.52	0.31	162.80	0.03	13.29
4.0	0.58	0.40	-165.20	0.03	11.45
5.0	0.68	0.46	-138.50	0.05	10.05
6.0	0.80	0.54	-115.00	0.09	8.97
7.0	0.89	0.57	-92.50	0.20	7.90
8.0	1.01	0.61	-72.80	0.35	6.90
9.0	1.09	0.65	-56.40	0.53	6.26
10.0	1.18	0.68	-42.60	0.69	5.99

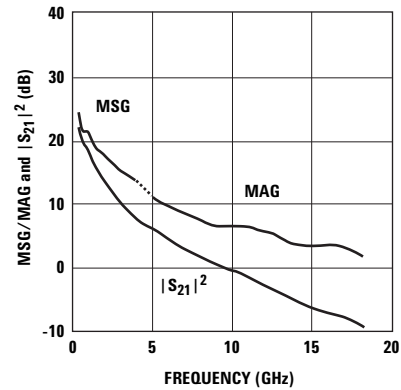

Figure 22. MSG/MAG and  $|S_{21}|^2$  vs. Frequency at 3V, 40 mA.

Notes:

1. The  $F_{min}$  values are based on a set of 16 noise figure measurements made at 16 different impedances using an ATF NP5 test system. From these measurements a true  $F_{min}$  is calculated. Refer to the noise parameter application section for more information.
2. S and noise parameters are measured on a microstrip line made on 0.025 inch thick alumina carrier. The input reference plane is at the end of the gate lead. The output reference plane is at the end of the drain lead. The parameters include the effect of four plated through via holes connecting source landing pads on top of the test carrier to the microstrip ground plane on the bottom side of the carrier. Two 0.020 inch diameter via holes are placed within 0.010 inch from each source lead contact point, one via on each side of that point.

### ATF-33143 Typical Scattering Parameters, $V_{DS} = 3V, I_{DS} = 60\text{ mA}$

Freq. (GHz)	$S_{11}$		$S_{21}$			$S_{12}$		$S_{22}$		MSG/MAG (dB)	
	Mag.	Ang.	dB	Mag.	Ang.	dB	Mag.	Ang.	Mag.		Ang.
0.5	0.87	-75.30	22.95	14.06	133.00	-28.18	0.039	55.10	0.27	-124.20	25.57
0.8	0.78	-114.70	20.22	10.26	110.00	-25.19	0.055	42.60	0.36	-153.90	22.71
1.0	0.77	-122.30	19.59	9.56	105.50	-24.89	0.057	40.50	0.37	-158.80	22.24
1.5	0.74	-151.60	16.78	6.91	87.60	-23.37	0.068	33.50	0.41	-178.70	20.07
1.8	0.73	-164.60	15.35	5.87	79.30	-22.87	0.072	30.80	0.43	-172.60	19.11
2.0	0.73	-171.80	14.47	5.30	74.40	-22.53	0.075	29.00	0.44	-167.50	18.49
2.5	0.73	171.00	12.60	4.27	62.80	-21.76	0.082	25.10	0.47	158.50	17.17
3.0	0.74	158.10	10.99	3.54	53.10	-21.07	0.089	21.40	0.50	151.00	16.00
4.0	0.75	136.40	8.56	2.68	35.40	-19.79	0.103	13.20	0.52	138.60	14.15
5.0	0.75	116.90	6.80	2.19	17.70	-18.68	0.117	2.80	0.52	124.40	11.53
6.0	0.77	97.80	5.28	1.84	-0.60	-17.88	0.128	-9.70	0.53	107.80	10.03
7.0	0.79	79.90	3.71	1.53	-18.60	-17.42	0.135	-23.20	0.56	90.20	8.66
8.0	0.82	64.50	2.26	1.30	-34.40	-17.29	0.137	-34.60	0.59	74.70	7.75
9.0	0.83	50.40	1.07	1.13	-48.50	-17.03	0.141	-44.50	0.62	62.70	6.81
10.0	0.86	36.40	0.12	1.02	-63.50	-16.49	0.150	-56.20	0.65	50.90	6.72
11.0	0.88	21.60	-0.94	0.90	-79.50	-16.43	0.151	-69.40	0.68	37.40	6.46
12.0	0.90	7.30	-2.13	0.78	-95.10	-16.71	0.146	-82.10	0.71	21.40	6.04
13.0	0.91	-5.00	-3.67	0.66	-109.70	-17.27	0.137	-94.00	0.74	5.80	4.99
14.0	0.91	-15.50	-4.93	0.57	-121.40	-17.72	0.130	-102.70	0.77	-6.10	3.98
15.0	0.92	-27.50	-5.85	0.51	-133.90	-17.86	0.128	-112.40	0.80	-15.80	3.78
16.0	0.93	-40.60	-6.70	0.46	-146.60	-17.72	0.130	-123.00	0.82	-25.80	3.54
17.0	0.94	-52.30	-7.61	0.42	-160.30	-17.92	0.127	-135.30	0.82	-37.90	3.45
18.0	0.93	-61.40	-8.97	0.36	-170.90	-18.64	0.117	-144.00	0.84	-49.70	2.08

### ATF-33143 Typical Noise Parameters

$V_{DS} = 3V, I_{DS} = 60\text{ mA}$

Freq. GHz	$F_{min}$ dB	$\Gamma_{opt}$		$R_{n/50}$ -	$G_a$ dB
		Mag.	Ang.		
0.5	0.23	0.43	29.20	0.06	25.64
0.9	0.28	0.35	42.40	0.06	21.62
1.0	0.29	0.35	45.00	0.07	20.87
1.5	0.34	0.26	68.80	0.06	17.84
1.8	0.34	0.23	93.30	0.04	16.89
2.0	0.38	0.22	109.70	0.05	16.24
2.5	0.52	0.25	150.60	0.03	14.93
3.0	0.53	0.30	167.50	0.03	13.52
4.0	0.61	0.39	-160.30	0.04	11.65
5.0	0.68	0.47	-134.70	0.06	10.28
6.0	0.83	0.52	-112.10	0.11	9.09
7.0	0.91	0.58	-89.70	0.22	8.09
8.0	1.04	0.61	-71.50	0.36	7.07
9.0	1.09	0.66	-54.80	0.56	6.43
10.0	1.13	0.70	-41.40	0.73	6.15

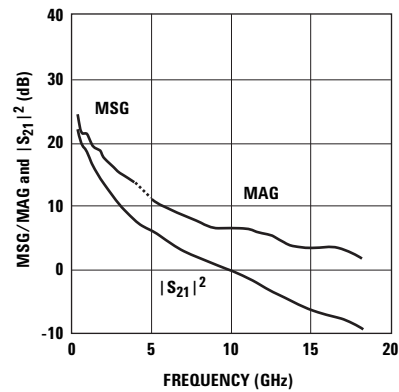

Figure 23. MSG/MAG and  $|S_{21}|^2$  vs. Frequency at 3V, 60 mA.

Notes:

1. The  $F_{min}$  values are based on a set of 16 noise figure measurements made at 16 different impedances using an ATF NP5 test system. From these measurements a true  $F_{min}$  is calculated. Refer to the noise parameter application section for more information.
2. S and noise parameters are measured on a microstrip line made on a 0.025 inch thick alumina carrier. The input reference plane is at the end of the gate lead. The output reference plane is at the end of the drain lead. The parameters include the effect of four plated through via holes connecting source landing pads on top of the test carrier to the microstrip ground plane on the bottom side of the carrier. Two 0.020 inch diameter via holes are placed within 0.010 inch from each source lead contact point, one via on each side of that point.

### ATF-33143 Typical Scattering Parameters, $V_{DS} = 4V, I_{DS} = 40\text{ mA}$

Freq. (GHz)	$S_{11}$			$S_{21}$			$S_{12}$		$S_{22}$		MSG/MAG (dB)
	Mag.	Ang.	dB	Mag.	Ang.	dB	Mag.	Ang.	Mag.	Ang.	
0.5	0.87	-72.50	22.73	13.74	134.30	-27.39	0.043	54.10	0.26	-104.90	25.04
0.8	0.78	-111.80	20.07	10.09	111.00	-24.42	0.060	40.40	0.33	-140.20	22.26
1.0	0.77	-119.40	19.46	9.43	106.40	-24.20	0.062	37.70	0.34	-147.10	21.82
1.5	0.73	-149.10	16.69	6.85	88.20	-22.90	0.072	29.80	0.38	-169.70	19.78
1.8	0.72	-162.20	15.28	5.82	79.80	-22.44	0.076	26.90	0.40	-179.30	18.84
2.0	0.72	-169.50	14.41	5.26	74.70	-22.23	0.078	25.00	0.41	-175.10	18.29
2.5	0.72	173.00	12.55	4.24	63.00	-21.58	0.084	21.20	0.44	165.10	17.03
3.0	0.73	159.80	10.95	3.53	53.20	-21.07	0.089	17.80	0.46	156.50	15.98
4.0	0.74	137.70	8.54	2.68	35.10	-19.93	0.101	10.40	0.48	142.50	14.23
5.0	0.75	117.90	6.80	2.19	17.10	-18.92	0.113	0.70	0.49	127.70	11.54
6.0	0.77	98.80	5.28	1.84	-1.60	-18.11	0.124	-11.20	0.50	111.00	10.07
7.0	0.79	80.80	3.72	1.54	-19.80	-17.68	0.130	-24.10	0.53	93.40	8.68
8.0	0.82	65.10	2.29	1.30	-35.90	-17.50	0.133	-35.10	0.56	77.30	7.77
9.0	0.83	50.90	1.10	1.14	-50.20	-17.23	0.137	-44.60	0.59	64.90	6.80
10.0	0.86	36.80	0.15	1.02	-65.60	-16.69	0.146	-56.10	0.62	53.00	6.78
11.0	0.88	22.00	-0.93	0.90	-81.80	-16.58	0.148	-69.10	0.65	39.50	6.55
12.0	0.90	7.60	-2.14	0.78	-97.60	-16.81	0.144	-81.70	0.69	23.50	6.13
13.0	0.91	-4.70	-3.69	0.66	-112.40	-17.32	0.136	-93.50	0.72	7.50	5.03
14.0	0.91	-15.30	-4.97	0.57	-124.50	-17.78	0.129	-102.10	0.76	-4.30	4.06
15.0	0.92	-27.20	-5.92	0.51	-137.30	-17.93	0.127	-112.20	0.79	-14.60	3.87
16.0	0.93	-40.30	-6.85	0.46	-150.10	-17.79	0.129	-122.80	0.81	-24.50	3.62
17.0	0.94	-52.20	-7.83	0.41	-163.80	-18.00	0.126	-135.10	0.82	-36.80	3.54
18.0	0.93	-61.20	-9.19	0.35	-174.60	-18.72	0.116	-143.80	0.84	-48.70	2.05

### ATF-33143 Typical Noise Parameters

$V_{DS} = 4V, I_{DS} = 40\text{ mA}$

Freq. GHz	$F_{min}$ dB	$\Gamma_{opt}$		$R_{n/50}$ -	$G_a$ dB
		Mag.	Ang.		
0.5	0.30	0.44	31.50	0.08	25.59
0.9	0.33	0.36	42.70	0.07	21.43
1.0	0.34	0.33	44.50	0.08	20.63
1.5	0.38	0.26	68.70	0.06	17.72
1.8	0.37	0.25	90.70	0.05	16.65
2.0	0.40	0.23	106.40	0.05	15.99
2.5	0.53	0.27	145.80	0.04	14.70
3.0	0.54	0.31	162.00	0.03	13.32
4.0	0.60	0.38	-165.30	0.04	11.47
5.0	0.68	0.46	-138.80	0.05	10.17
6.0	0.82	0.49	-115.40	0.09	8.93
7.0	0.89	0.56	-93.20	0.19	7.99
8.0	1.00	0.60	-73.10	0.33	7.00
9.0	1.07	0.66	-56.60	0.50	6.40
10.0	1.16	0.68	-42.80	0.65	6.11

Notes:

1. The  $F_{min}$  values are based on a set of 16 noise figure measurements made at 16 different impedances using an ATF NP5 test system. From these measurements a true  $F_{min}$  is calculated. Refer to the noise parameter application section for more information.
2. S and noise parameters are measured on a microstrip line made on 0.025 inch thick alumina carrier. The input reference plane is at the end of the gate lead. The output reference plane is at the end of the drain lead. The parameters include the effect of four plated through via holes connecting source landing pads on top of the test carrier to the microstrip ground plane on the bottom side of the carrier. Two 0.020 inch diameter via holes are placed within 0.010 inch from each source lead contact point, one via on each side of that point.

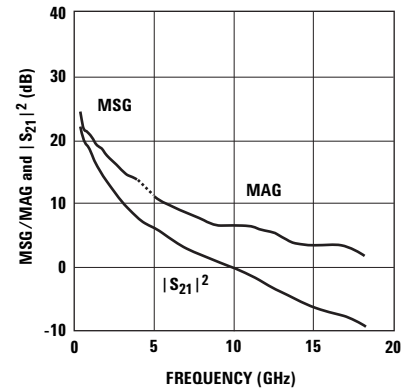

Figure 24. MSG/MAG and  $|S_{21}|^2$  vs. Frequency at 4V, 40 mA.

### ATF-33143 Typical Scattering Parameters, $V_{DS} = 4V, I_{DS} = 60\text{ mA}$

Freq. (GHz)	$S_{11}$			$S_{21}$			$S_{12}$		$S_{22}$		MSG/MAG (dB)
	Mag.	Ang.	dB	Mag.	Ang.	dB	Mag.	Ang.	Mag.	Ang.	
0.5	0.86	-75.60	23.20	14.45	132.90	-28.18	0.039	54.80	0.26	-118.50	25.69
0.8	0.77	-115.00	20.45	10.53	109.80	-25.35	0.054	42.20	0.34	-150.00	22.90
1.0	0.76	-122.50	19.80	9.77	105.30	-25.04	0.056	40.20	0.35	-155.50	22.42
1.5	0.73	-151.80	16.98	7.06	87.50	-23.61	0.066	33.20	0.39	-176.10	20.29
1.8	0.72	-164.60	15.55	5.99	79.20	-22.97	0.071	30.60	0.41	175.00	19.26
2.0	0.72	-171.80	14.66	5.41	74.20	-22.73	0.073	28.90	0.42	169.80	18.70
2.5	0.72	171.00	12.79	4.36	62.70	-21.94	0.080	25.10	0.45	160.60	17.36
3.0	0.73	158.20	11.17	3.62	53.00	-21.31	0.086	21.60	0.47	152.70	16.24
4.0	0.74	136.50	8.76	2.74	35.20	-20.00	0.100	13.70	0.49	139.90	13.79
5.0	0.75	117.00	7.00	2.24	17.50	-18.86	0.114	3.40	0.50	125.70	11.57
6.0	0.77	98.00	5.48	1.88	-1.00	-17.99	0.126	-8.90	0.51	109.10	10.15
7.0	0.79	80.20	3.92	1.57	-19.00	-17.52	0.133	-22.30	0.54	91.60	8.80
8.0	0.82	64.70	2.48	1.33	-34.90	-17.39	0.135	-33.60	0.57	75.90	7.88
9.0	0.83	50.60	1.29	1.16	-49.10	-17.08	0.140	-43.40	0.60	63.70	6.92
10.0	0.86	36.60	0.34	1.04	-64.30	-16.54	0.149	-55.20	0.63	52.00	6.92
11.0	0.88	21.80	-0.72	0.92	-80.40	-16.48	0.150	-68.40	0.66	38.50	6.69
12.0	0.90	7.50	-1.94	0.80	-96.20	-16.71	0.146	-81.10	0.70	22.50	6.27
13.0	0.91	-4.80	-3.48	0.67	-110.80	-17.27	0.137	-92.90	0.73	6.70	5.14
14.0	0.91	-15.40	-4.73	0.58	-122.80	-17.65	0.131	-101.60	0.76	-5.20	4.12
15.0	0.92	-27.30	-5.68	0.52	-135.40	-17.79	0.129	-111.60	0.79	-15.20	3.90
16.0	0.93	-40.40	-6.56	0.47	-148.30	-17.72	0.130	-122.20	0.81	-25.10	3.72
17.0	0.94	-52.20	-7.54	0.42	-162.10	-17.92	0.127	-134.70	0.82	-37.30	3.59
18.0	0.93	-61.20	-8.87	0.36	-172.80	-18.56	0.118	-143.30	0.84	-49.20	2.19

### ATF-33143 Typical Noise Parameters

$V_{DS} = 4V, I_{DS} = 60\text{ mA}$

Freq. GHz	$F_{min}$ dB	$\Gamma_{opt}$ Mag.	Ang.	$R_{n/50}$ -	$G_a$ dB
0.5	0.29	0.42	31.40	0.08	25.91
0.9	0.33	0.33	44.70	0.07	21.80
1.0	0.34	0.32	48.00	0.07	21.00
1.5	0.38	0.26	71.90	0.06	18.14
1.8	0.39	0.22	94.00	0.05	16.96
2.0	0.42	0.22	109.70	0.05	16.29
2.5	0.47	0.25	149.40	0.03	14.95
3.0	0.51	0.29	166.80	0.03	13.58
4.0	0.63	0.39	-160.60	0.04	11.74
5.0	0.72	0.46	-135.30	0.06	10.36
6.0	0.82	0.51	-112.40	0.11	9.17
7.0	0.93	0.57	-90.90	0.21	8.18
8.0	1.03	0.61	-71.80	0.37	7.19
9.0	1.13	0.66	-55.50	0.55	6.56
10.0	1.22	0.69	-41.80	0.72	6.29

Notes:

- The  $F_{min}$  values are based on a set of 16 noise figure measurements made at 16 different impedances using an ATF NP5 test system. From these measurements a true  $F_{min}$  is calculated. Refer to the noise parameter application section for more information.
- S and noise parameters are measured on a microstrip line made on 0.025 inch thick alumina carrier. The input reference plane is at the end of the gate lead. The output reference plane is at the end of the drain lead. The parameters include the effect of four plated through via holes connecting source landing pads on top of the test carrier to the microstrip ground plane on the bottom side of the carrier. Two 0.020 inch diameter via holes are placed within 0.010 inch from each source lead contact point, one via on each side of that point.

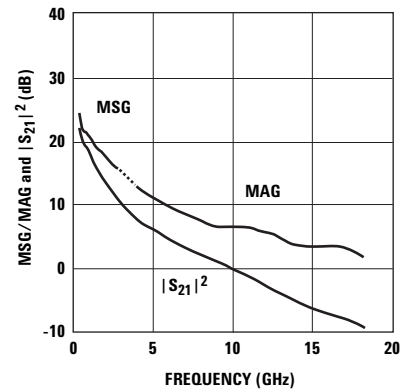

Figure 25. MSG/MAG and  $|S_{21}|^2$  vs. Frequency at 4V, 60 mA.

### ATF-33143 Typical Scattering Parameters, $V_{DS} = 4V, I_{DS} = 80\text{ mA}$

Freq. (GHz)	$S_{11}$			$S_{21}$			$S_{12}$		$S_{22}$		MSG/MAG (dB)
	Mag.	Ang.	dB	Mag.	Ang.	dB	Mag.	Ang.	Mag.	Ang.	
0.5	0.86	-77.20	23.39	14.76	132.20	-28.82	0.036	55.30	0.26	-125.40	26.13
0.8	0.77	-116.60	20.60	10.71	109.20	-25.86	0.051	43.40	0.34	-154.80	23.22
1.0	0.76	-124.00	19.93	9.91	104.80	-25.49	0.053	41.70	0.36	-159.50	22.72
1.5	0.73	-153.00	17.09	7.15	87.10	-23.86	0.064	35.20	0.39	-179.10	20.48
1.8	0.72	-165.80	15.66	6.06	78.90	-23.31	0.068	32.70	0.41	172.40	19.50
2.0	0.72	-172.90	14.77	5.47	74.00	-22.95	0.071	31.00	0.42	167.30	18.87
2.5	0.72	170.10	12.89	4.41	62.50	-22.03	0.079	27.20	0.45	158.50	17.47
3.0	0.73	157.40	11.27	3.66	53.00	-21.39	0.085	23.50	0.48	151.00	16.34
4.0	0.74	136.00	8.84	2.77	35.30	-20.00	0.100	15.30	0.50	138.80	13.59
5.0	0.75	116.70	7.09	2.26	17.70	-18.86	0.114	4.80	0.51	124.80	11.56
6.0	0.77	97.70	5.57	1.90	-0.70	-17.99	0.126	-7.80	0.52	108.40	10.17
7.0	0.79	80.00	4.00	1.58	-18.70	-17.47	0.134	-21.30	0.55	90.90	8.84
8.0	0.82	64.50	2.55	1.34	-34.50	-17.34	0.136	-32.80	0.58	75.40	7.93
9.0	0.83	50.50	1.36	1.17	-48.70	-17.03	0.141	-42.80	0.61	63.30	6.98
10.0	0.86	36.50	0.43	1.05	-63.80	-16.49	0.150	-54.60	0.63	51.60	6.96
11.0	0.88	21.70	-0.65	0.93	-79.90	-16.38	0.152	-67.80	0.66	38.10	6.73
12.0	0.90	7.40	-1.85	0.81	-95.60	-16.66	0.147	-80.60	0.70	22.10	6.26
13.0	0.91	-4.80	-3.39	0.68	-110.20	-17.21	0.138	-92.60	0.73	6.40	5.21
14.0	0.91	-15.40	-4.64	0.59	-122.00	-17.59	0.132	-101.10	0.76	-5.00	4.20
15.0	0.92	-27.30	-5.57	0.53	-134.80	-17.79	0.129	-111.20	0.79	-15.40	3.98
16.0	0.93	-40.40	-6.46	0.47	-147.60	-17.65	0.131	-121.90	0.81	-25.30	3.73
17.0	0.94	-52.20	-7.40	0.43	-161.40	-17.85	0.128	-134.30	0.82	-37.50	3.65
18.0	0.93	-61.20	-8.75	0.36	-172.10	-18.56	0.118	-143.10	0.84	-49.30	2.24

### ATF-33143 Typical Noise Parameters

$V_{DS} = 4V, I_{DS} = 80\text{ mA}$

Freq. GHz	$F_{min}$ dB	$\Gamma_{opt}$		$R_{n/50}$ -	$G_a$ dB
		Mag.	Ang.		
0.5	0.30	0.42	34.50	0.08	26.23
0.9	0.35	0.32	46.40	0.07	21.96
1.0	0.35	0.32	50.40	0.07	21.16
1.5	0.40	0.23	74.80	0.06	18.47
1.8	0.42	0.20	98.80	0.05	17.18
2.0	0.45	0.19	114.10	0.05	16.48
2.5	0.49	0.23	153.70	0.04	15.09
3.0	0.55	0.28	171.50	0.03	13.70
4.0	0.68	0.38	-156.70	0.04	11.85
5.0	0.75	0.48	-133.30	0.07	10.49
6.0	0.90	0.52	-110.70	0.13	9.27
7.0	1.00	0.57	-89.60	0.25	8.27
8.0	1.12	0.62	-70.80	0.43	7.28
9.0	1.19	0.67	-54.60	0.65	6.66
10.0	1.33	0.69	-40.80	0.85	6.31

Notes:

- The  $F_{min}$  values are based on a set of 16 noise figure measurements made at 16 different impedances using an ATF NP5 test system. From these measurements a true  $F_{min}$  is calculated. Refer to the noise parameter application section for more information.
- S and noise parameters are measured on a microstrip line made on a 0.025 inch thick alumina carrier. The input reference plane is at the end of the gate lead. The output reference plane is at the end of the drain lead. The parameters include the effect of four plated through via holes connecting source landing pads on top of the test carrier to the microstrip ground plane on the bottom side of the carrier. Two 0.020 inch diameter via holes are placed within 0.010 inch from each source lead contact point, one via on each side of that point.

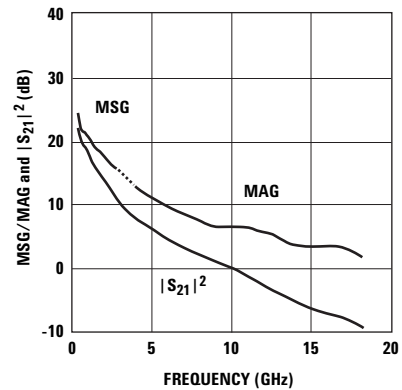

Figure 26. MSG/MAG and  $|S_{21}|^2$  vs. Frequency at 4V, 80 mA.

## Noise Parameter Applications Information

$F_{min}$  values at 2 GHz and higher are based on measurements while the  $F_{mins}$  below 2 GHz have been extrapolated. The  $F_{min}$  values are based on a set of 16 noise figure measurements made at 16 different impedances using an ATN NP5 test system. From these measurements, a true  $F_{min}$  is calculated.  $F_{min}$  represents the true minimum noise figure of the device when the device is presented with an impedance matching network that transforms the source impedance, typically  $50\Omega$ , to an impedance represented by the reflection coefficient  $\Gamma_o$ . The designer must design a matching network that will present  $\Gamma_o$  to the device with minimal associated circuit losses. The noise figure of the completed amplifier is equal to the noise figure of the device plus the losses of the matching network preceding the device. The noise figure of the device is equal to  $F_{min}$  only when the device is presented with  $\Gamma_o$ . If the reflection coefficient of the matching network is other than  $\Gamma_o$ , then the noise figure of the device will be greater than  $F_{min}$  based on the following equation.

$$NF = F_{min} + \frac{4R_n}{Z_o} \frac{|\Gamma_s - \Gamma_o|^2}{(1 + |\Gamma_o|^2)(1 - |\Gamma_s|^2)}$$

Where  $R_n/Z_o$  is the normalized noise resistance,  $\Gamma_o$  is the optimum reflection coefficient required to produce  $F_{min}$  and  $\Gamma_s$  is the reflection coefficient of the source impedance actually presented to the device. The losses

of the matching networks are non-zero and they will also add to the noise figure of the device creating a higher amplifier noise figure. The losses of the matching networks are related to the Q of the components and associated printed circuit board loss.  $\Gamma_o$  is typically fairly low at higher frequencies and increases as frequency is lowered. Larger gate width devices will typically have a lower  $\Gamma_o$  as compared to narrower gate width devices.

Typically for FETs, the higher  $\Gamma_o$  usually infers that an impedance much higher than  $50\Omega$  is required for the device to produce  $F_{min}$ . At VHF frequencies and even lower L Band frequencies, the required impedance can be in the vicinity of several thousand ohms. Matching to such a high impedance requires very hi-Q components in order to minimize circuit losses. As an example at 900 MHz, when airwound coils ( $Q > 100$ ) are used for matching networks, the loss can still be up to 0.25 dB which will add directly to the noise figure of the device. Using multilayer molded inductors with Qs in the 30 to 50 range results in additional loss over the airwound coil. Losses as high as 0.5 dB or greater add to the typical 0.15 dB  $F_{min}$  of the device creating an amplifier noise figure of nearly 0.65 dB. A discussion concerning calculated and measured circuit losses and their effect on amplifier noise figure is covered in Avago Application 1085.

## Reliability Data

Channel Temperature (°C)	Nominal Failures per million (FPM) for different durations					90% confidence Failures per million (FPM) for different durations				
	(FITs) 1000 hours	1 year	5 year	10 year	30 year	(FITs) 1000 hours	1 year	5 year	10 year	30 year
100	<0.1	<0.1	<0.1	<0.1	<0.1	<0.1	<0.1	<0.1	<0.1	<0.1
125	<0.1	<0.1	<0.1	<0.1	<0.1	<0.1	<0.1	<0.1	<0.1	11
140	<0.1	<0.1	<0.1	<0.1	160	<0.1	<0.1	6	160	9.3K
150	<0.1	<0.1	2	140	26K	<0.1	0.3	780	8800	131K
160	<0.1	<0.1	920	21K	370K	<0.1	67	24K	120K	520K
180	<0.1	4400	450K	830K	1000K	21	53K	590K	850K	1000K
NOT recommended										

Predicted failures with temperature extrapolated from failure distribution and activation energy data of higher temperature operational life STRIFE of PHEMT process

# ATF-33143 Die Model

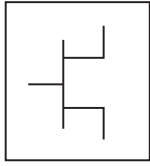

Statz Model

MESFETM1

NFET=yes

PFET=no

Vto=-0.95

Beta=0.48

Lambda=0.09

Alpha=4

B=0.8

Tnom=27

ldstc=

Vbi=0.7

Tau=

Betatce=

Delta1=0.2

Delta2=

Gscap=3

Cgs=1.6 pF

Gdcap=3

Cgd=0.32 pF

Rgd=

Tqm=

Vmax=

Fc=

Rd=.125

Rg=1

Rs=0.0625

Ld=0.00375 nH

Lg=0.00375 nH

Ls=0.00125 nH

Cds=0.08 pF

Crf=0.1

Rc=62.5

Gsfwd=1

Gsrev=0

Gdfwd=1

Gdrev=0

Vjr=1

Is=1 nA

Ir=1 nA

Imax=0.1

Xti=

N=

Eg=

Vbr=

Vtotc=

Rin=

Taumd1=no

Fnc=1E6

R=0.17

C=0.2

P=0.65

wVgfwd=

wBvgs=

wBvgd=

wBvds=

wldsmx=

wPmax=

AllParams=

This model can be used as a design tool. It has been tested on MDS for various specifications. However, for more precise and accurate design, please refer to the measured data in this data sheet. For future improvements Avago reserves the right to change these models without prior notice.

## ATF-33143 Model

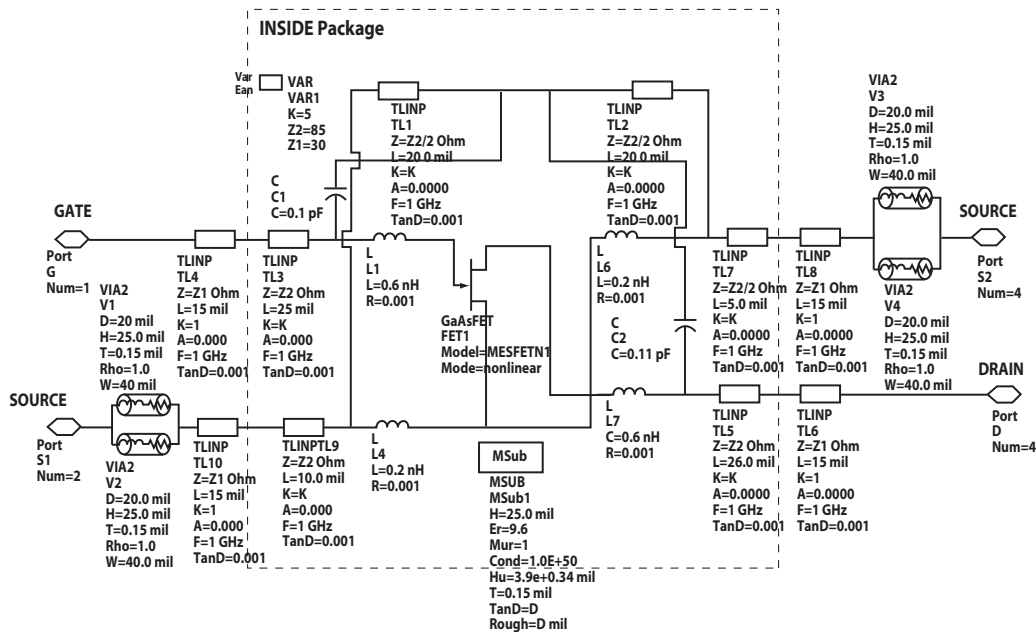

## Part Number Ordering Information

Part Number	No. of Devices	Container
ATF-33143-TR1G	3000	7" Reel
ATF-33143-TR2G	10000	13" Reel
ATF-33143-BLKG	100	antistatic bag

## Package Dimensions SC-70 4L/SOT-343

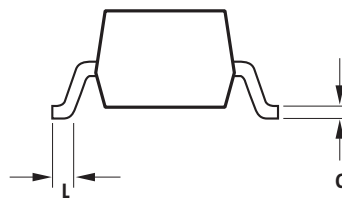
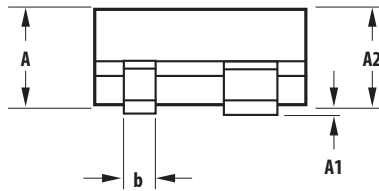
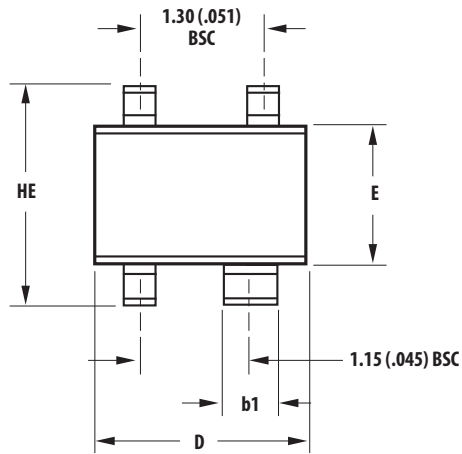

SYMBOL	DIMENSIONS (mm)	
	MIN.	MAX.
E	1.15	1.35
D	1.85	2.25
HE	1.80	2.40
A	0.80	1.10
A2	0.80	1.00
A1	0.00	0.10
b	0.15	0.40
b1	0.55	0.70
c	0.10	0.20
L	0.10	0.46

## Recommended PCB Pad Layout for Avago's SC70 4L/SOT-343 Products

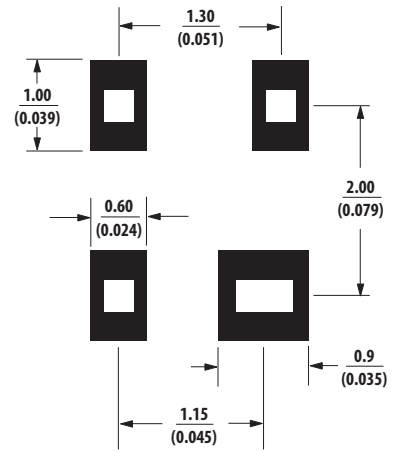

Dimensions in  $\frac{\text{mm}}{\text{(inches)}}$

### NOTES:

1. All dimensions are in mm.
2. Dimensions are inclusive of plating.
3. Dimensions are exclusive of mold flash & metal burr.
4. All specifications comply to EIAJ SC70.
5. Die is facing up for mold and facing down for trim/form, ie: reverse trim/form.
6. Package surface to be mirror finish.



## Device Orientation

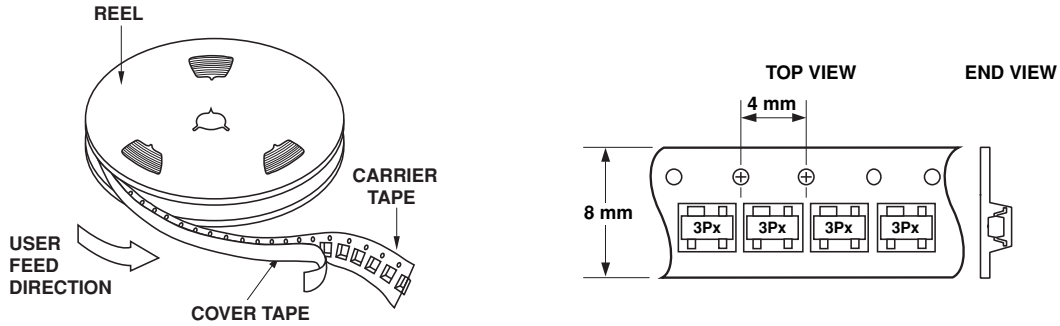

## Tape Dimensions and Product Orientation For Outline 4T

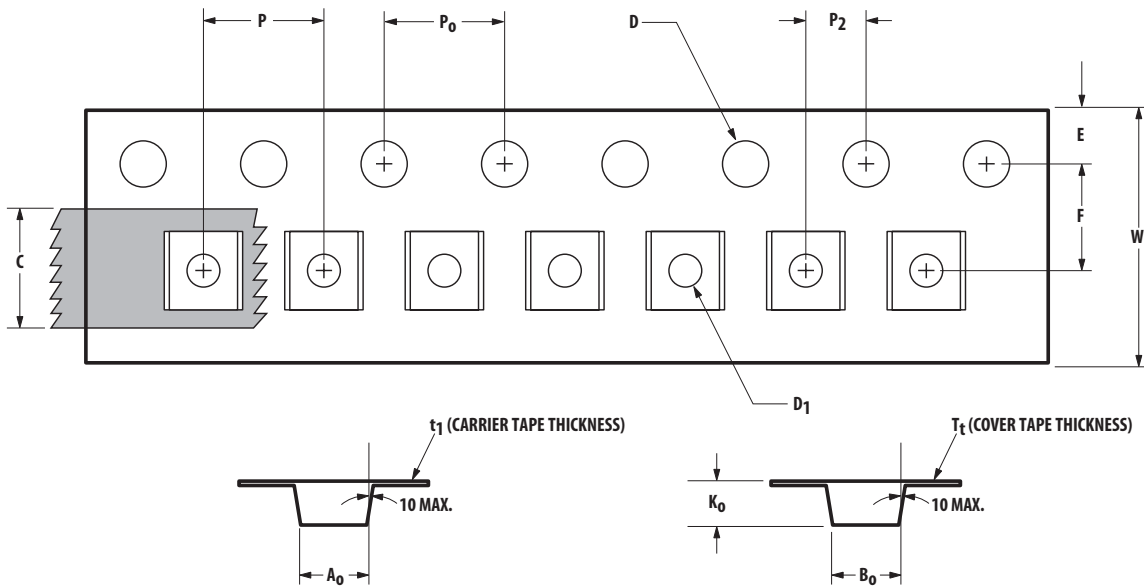

DESCRIPTION		SYMBOL	SIZE (mm)	SIZE (INCHES)
CAVITY	LENGTH	$A_0$	$2.40 \pm 0.10$	$0.094 \pm 0.004$
	WIDTH	$B_0$	$2.40 \pm 0.10$	$0.094 \pm 0.004$
	DEPTH	$K_0$	$1.20 \pm 0.10$	$0.047 \pm 0.004$
	PITCH	$P$	$4.00 \pm 0.10$	$0.157 \pm 0.004$
	BOTTOM HOLE DIAMETER	$D_1$	$1.00 + 0.25$	$0.039 + 0.010$
PERFORATION	DIAMETER	$D$	$1.55 \pm 0.10$	$0.061 + 0.002$
	PITCH	$P_0$	$4.00 \pm 0.10$	$0.157 \pm 0.004$
	POSITION	$E$	$1.75 \pm 0.10$	$0.069 \pm 0.004$
CARRIER TAPE	WIDTH	$W$	$8.00 + 0.30 - 0.10$	$0.315 + 0.012$
	THICKNESS	$t_1$	$0.254 \pm 0.02$	$0.0100 \pm 0.0008$
COVER TAPE	WIDTH	$C$	$5.40 \pm 0.10$	$0.205 + 0.004$
	TAPE THICKNESS	$T_t$	$0.062 \pm 0.001$	$0.0025 \pm 0.0004$
DISTANCE	CAVITY TO PERFORATION (WIDTH DIRECTION)	$F$	$3.50 \pm 0.05$	$0.138 \pm 0.002$
	CAVITY TO PERFORATION (LENGTH DIRECTION)	$P_2$	$2.00 \pm 0.05$	$0.079 \pm 0.002$

For product information and a complete list of distributors, please go to our web site: [www.avagotech.com](http://www.avagotech.com)

Avago, Avago Technologies, and the A Logo are trademarks of Avago Technologies in the United States and other countries. Data subject to change. Copyright © 2005-2012 Avago Technologies. All rights reserved. Obsoletes 5989-3747EN AV02-1442EN - June 8, 2012

