

ATF-38143

Low Noise Pseudomorphic HEMT in a Surface Mount Plastic Package



Data Sheet

Description

Avago Technologies's ATF-38143 is a high dynamic range, low noise, PHEMT housed in a 4-lead SC-70 (SOT-343) surface mount plastic package.

Based on its featured performance, ATF-38143 is suitable for applications in cellular and PCS handsets, LEO systems, MMDS, and other systems requiring super low noise figure with good intercept in the 450 MHz to 10 GHz frequency range.

Surface Mount Package SOT-343

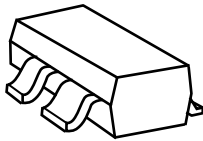

Pin Connections and Package Marking

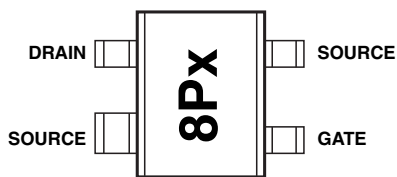

Note:
Top View. Package marking provides orientation and identification.
"8P" = Device code
"x" = Date code character.
A new character is assigned for each month, year.

Features

- Lead-free Option Available
- Low Noise Figure
- Excellent Uniformity in Product Specifications
- Low Cost Surface Mount Small Plastic Package SOT-343 (4 lead SC-70)
- Tape-and-Reel Packaging Option Available

Specifications

1.9 GHz; 2 V, 10 mA (Typ.)

- 0.4 dB Noise Figure
- 16 dB Associated Gain
- 12.0 dBm Output Power at 1 dB Gain Compression
- 22.0 dBm Output 3rd Order Intercept

Applications

- Low Noise Amplifier for Cellular/PCS Handsets
- LNA for WLAN, WLL/RLL, LEO, and MMDS Applications
- General Purpose Discrete PHEMT for Other Ultra Low Noise Applications



Attention: Observe precautions for handling electrostatic sensitive devices.
ESD Machine Model (Class A)
ESD Human Body Model (Class 1)
Refer to Avago Application Note A004R:
Electrostatic Discharge Damage and Control.

ATF-38143 Absolute Maximum Ratings^[1]

Symbol	Parameter	Units	Absolute Maximum
V_{DS}	Drain - Source Voltage ^[2]	V	4.5
V_{GS}	Gate - Source Voltage	V	-4
V_{GD}	Gate Drain Voltage	V	-4
I_{DS}	Drain Current	mA	I_{dss}
P_{diss}	Total Power Dissipation ^[2]	mW	580
$P_{in\ max}$	RF Input Power	dBm	17
T_{CH}	Channel Temperature	°C	160
T_{STG}	Storage Temperature	°C	-65 to 160
θ_{jc}	Thermal Resistance ^[3]	°C/W	165

Notes:

1. Operation of this device above any one of these parameters may cause permanent damage.
2. Source lead temperature is 25°C. Derate 6 mW/°C for $T_L > 64^\circ\text{C}$.
3. Thermal resistance measured using 150°C Liquid Crystal Measurement method.

Product Consistency Distribution Charts

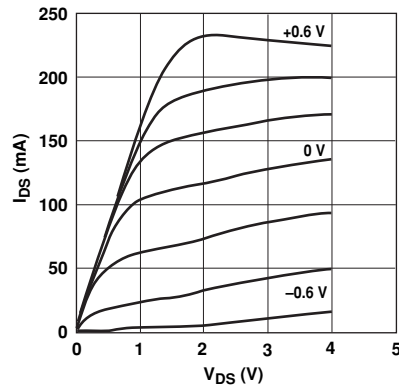

Figure 1. Typical I-V Curves. ($V_{GS} = -0.2\text{V}$ per step)

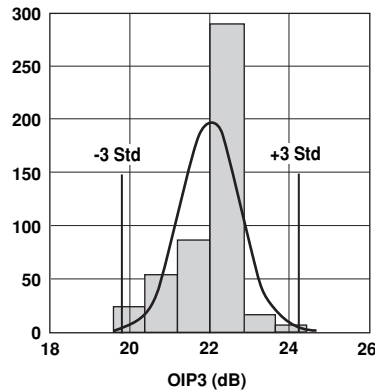

Figure 2. OIP3 @ 2 GHz, 2 V, 10 mA.
LSL=18.5, Nominal=21.99, USL=26.0

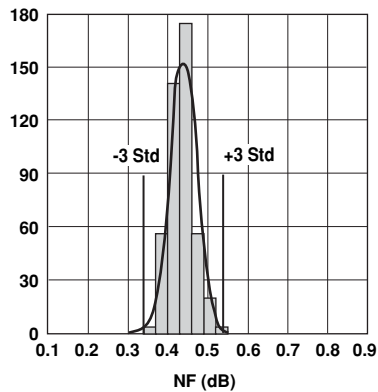

Figure 3. NF @ 2 GHz, 2 V, 10 mA.
LSL=0, Nominal=0.44, USL=0.85

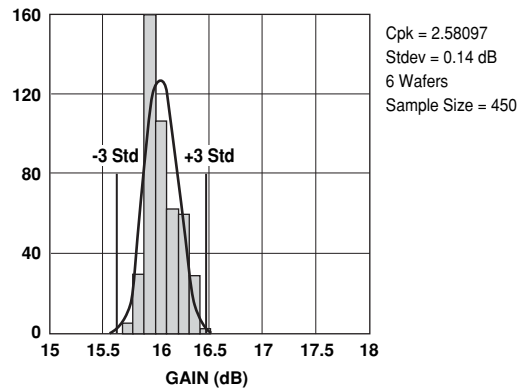

Figure 4. Gain @ 2 GHz, 2 V, 10 mA.
LSL=15.0, Nominal=16.06, USL= 18.0

Note:

Distribution data sample size is 450 samples taken from 6 different wafers. Future wafers allocated to this product may have nominal values anywhere within the upper and lower spec limits. Measurements made on production test board. This circuit represents a trade-off between

an optimal noise match and a realizeable match based on production test requirements. Circuit losses have been de-embedded from actual measurements.

ATF-38143 Electrical Specifications $T_A = 25^\circ\text{C}$, RF parameters measured in a test circuit for a typical device

Symbol	Parameters and Test Conditions	Units	Min.	Typ. ^[2]	Max.	
$I_{dss}^{[1]}$	Saturated Drain Current $V_{DS} = 1.5\text{ V}, V_{GS} = 0\text{ V}$	mA	90	118	145	
$V_p^{[1]}$	Pinchoff Voltage $V_{DS} = 1.5\text{ V}, I_{DS} = 10\% \text{ of } I_{dss}$	V	-0.65	-0.5	-0.35	
I_d	Quiescent Bias Current $V_{GS} = -0.54\text{ V}, V_{DS} = 2\text{ V}$	mA	—	10	—	
$g_m^{[1]}$	Transconductance $V_{DS} = 1.5\text{ V}, g_m = I_{dss}/V_p$	mmho	180	230	—	
I_{GDO}	Gate to Drain Leakage Current $V_{GD} = -5\text{ V}$	μA	—	—	500	
I_{gss}	Gate Leakage Current $V_{GD} = V_{GS} = -4\text{ V}$	μA	—	30	300	
NF	Noise Figure	f = 2 GHz	$V_{DS} = 2\text{ V}, I_{DS} = 5\text{ mA}$	dB	0.6	0.85
			$V_{DS} = 2\text{ V}, I_{DS} = 10\text{ mA}$		0.4	
			$V_{DS} = 2\text{ V}, I_{DS} = 20\text{ mA}$		0.3	
		f = 900 MHz	$V_{DS} = 2\text{ V}, I_{DS} = 5\text{ mA}$	dB	0.6	
			$V_{DS} = 2\text{ V}, I_{DS} = 10\text{ mA}$		0.4	
			$V_{DS} = 2\text{ V}, I_{DS} = 20\text{ mA}$		0.3	
G_a	Associated Gain ^[3]	f = 2 GHz	$V_{DS} = 2\text{ V}, I_{DS} = 5\text{ mA}$	dB	15.3	18
			$V_{DS} = 2\text{ V}, I_{DS} = 10\text{ mA}$		15	
			$V_{DS} = 2\text{ V}, I_{DS} = 20\text{ mA}$		17.0	
		f = 900 MHz	$V_{DS} = 2\text{ V}, I_{DS} = 5\text{ mA}$	dB	17.0	
			$V_{DS} = 2\text{ V}, I_{DS} = 10\text{ mA}$		19.0	
			$V_{DS} = 2\text{ V}, I_{DS} = 20\text{ mA}$		20.5	
OIP3	Output 3 rd Order Intercept Point ^[3]	f = 2 GHz	$V_{DS} = 2\text{ V}, I_{DS} = 10\text{ mA}$	dBm	18.5	22.0
		f = 900 MHz	$V_{DS} = 2\text{ V}, I_{DS} = 10\text{ mA}$	dBm	—	22.0
IIP3	Input 3 rd Order Intercept Point ^[3]	f = 2 GHz	$V_{DS} = 2\text{ V}, I_{DS} = 10\text{ mA}$	dBm	—	6.0
		f = 900 MHz	$V_{DS} = 2\text{ V}, I_{DS} = 10\text{ mA}$	dBm	—	3.0
P_{1dB}	1 dB Compressed Compressed Power ^[3]	f = 2 GHz	$V_{DS} = 2\text{ V}, I_{DS} = 10\text{ mA}$	dBm	—	12.0
		f = 900 MHz	$V_{DS} = 2\text{ V}, I_{DS} = 10\text{ mA}$	dBm	—	12.0

Notes:

1. Guaranteed at wafer probe level.
2. Typical value determined from a sample size of 450 parts from 6 wafers.
3. Measurements obtained using production test board described in Figure 5.

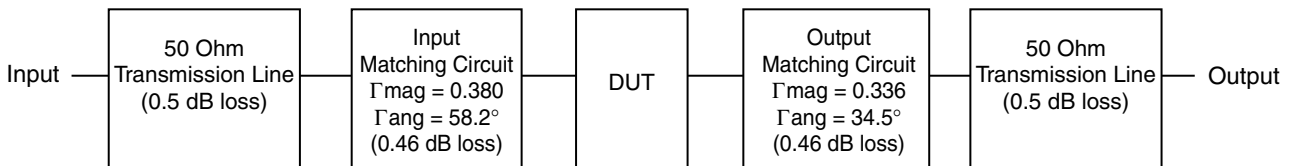

Figure 5. Block diagram of 2 GHz production test board used for Noise Figure, Associated Gain, P_{1dB} , and OIP3 measurements. This circuit represents a trade-off between an optimal noise match and a realizable match based on production test board requirements. Circuit losses have been de-embedded from actual measurements.

ATF-38143 Typical Performance Curves

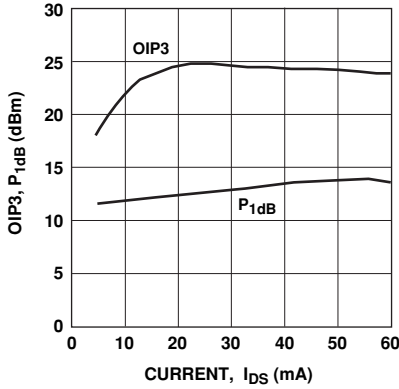

Figure 6. OIP3 and P_{1dB} vs. I_d at 2V, 2 GHz.

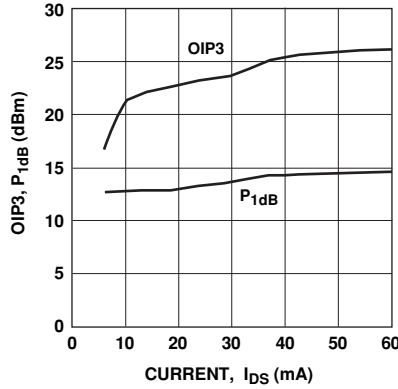

Figure 7. OIP3 and P_{1dB} vs. I_d at 2V, 900 MHz.

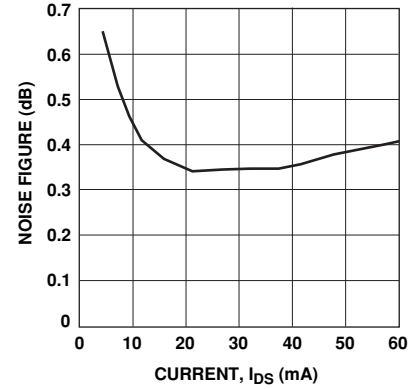

Figure 8. Noise Figure vs. I_d at 2V, 2 GHz.

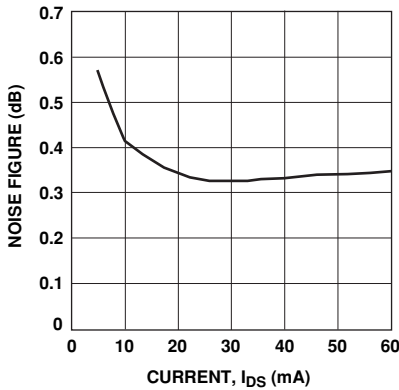

Figure 9. Noise Figure vs. I_d at 2V, 900 MHz.

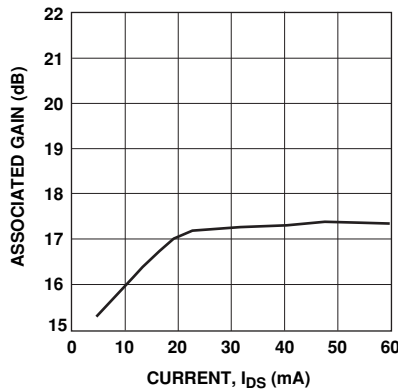

Figure 10. Associated Gain vs. I_d at 2V, 2 GHz.

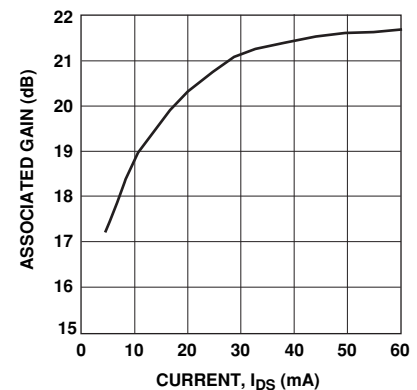

Figure 11. Associated Gain vs. I_d at 2V, 900 MHz.

Notes:

1. Measurements made on a fixed tuned production test board that was tuned for optimal gain match with reasonable noise figure at 2V 10 mA bias. This circuit represents a trade-off between an optimal noise match, maximum gain match and a realizable match based on production test board requirements. Circuit losses have been de-embedded from actual measurements.
2. P_{1dB} measurements are performed with passive biasing. Quiescent drain current, I_{DSQ} , is set with zero RF drive applied. As P_{1dB} is approached, the drain current may increase or decrease depending on frequency and dc bias point. At lower values of I_{DSQ} the device is running closer to class B as power output approaches P_{1dB} . This results in higher P_{1dB} and higher PAE (power added efficiency) when compared to a device that is driven by a constant current source as is typically done with active biasing.

ATF-38143 Typical Performance Curves, continued

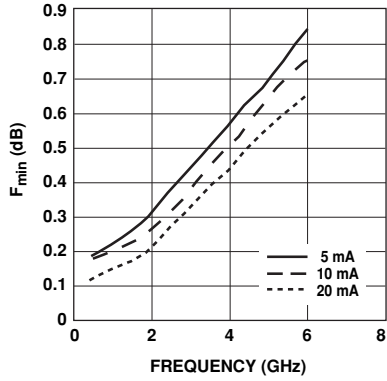

Figure 12. F_{min} vs. Frequency and Current at 2V.

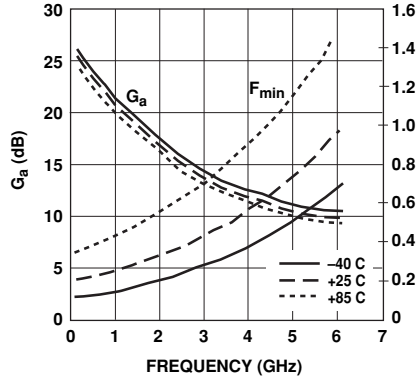

Figure 13. F_{min} and G_a vs. Frequency and Temperature at 2V, 10 mA.

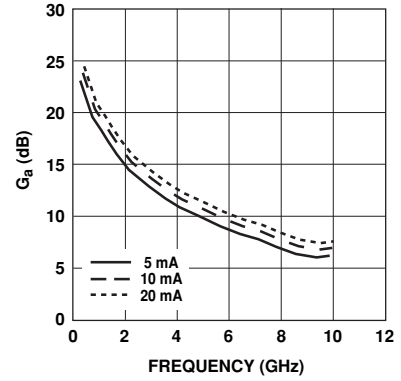

Figure 14. Associated Gain vs. Frequency and Current at 2V.

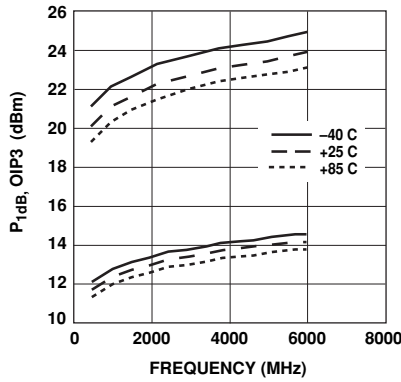

Figure 15. P_{1dB} and OIP3 vs. Frequency and Temperature at 2V, 10 mA.

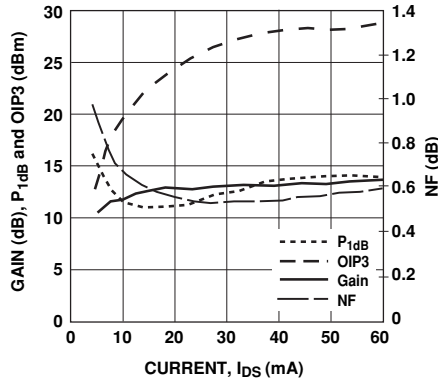

Figure 16. NF, Gain, P_{1dB} and OIP3 vs. I_{DS} at 2V, 3.9 GHz.

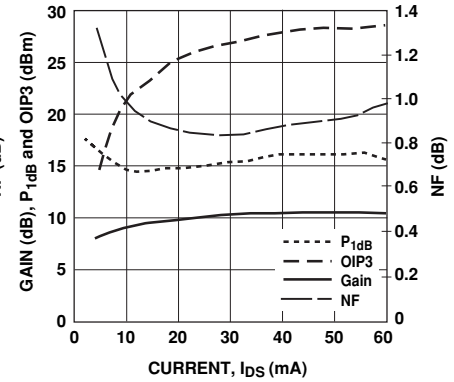

Figure 17. NF, Gain, P_{1dB} and OIP3 vs. I_{DS} at 2V, 5.8 GHz.

Notes:

1. P_{1dB} measurements are performed with passive biasing. Quiescent drain current, I_{DSQ} is set with zero RF drive applied. As P_{1dB} is approached, the drain current may increase or decrease depending on frequency and dc bias point. At lower values of I_{DSQ} the device is running closer to class B as power output approaches P_{1dB} . This results in higher P_{1dB} and higher PAE (power added efficiency) when compared to a device that is driven by a constant current source as is typically done with active biasing.

ATF-38143 Typical Scattering Parameters, $V_{DS} = 2\text{ V}$, $I_{DS} = 5\text{ mA}$

Freq. (GHz)	S_{11}			S_{21}			S_{12}		S_{22}		MSG/MAG (dB)
	Mag.	Ang.	dB	Mag.	Ang.	dB	Mag.	Ang.	Mag.	Ang.	
0.5	0.98	-25	14.47	5.289	160	-26.56	0.047	73	0.67	-21	20.51
0.8	0.95	-40	14.19	5.122	148	-22.85	0.072	63	0.65	-32	18.52
1.0	0.93	-51	14.00	5.010	140	-21.21	0.087	56	0.62	-40	17.60
1.5	0.87	-75	13.28	4.613	122	-18.49	0.119	41	0.56	-58	15.88
1.8	0.82	-89	12.79	4.362	111	-17.52	0.133	33	0.52	-69	15.16
2.0	0.80	-98	12.45	4.192	105	-16.95	0.142	28	0.50	-77	14.70
2.5	0.75	-120	11.48	3.751	89	-16.19	0.155	16	0.44	-94	13.84
3.0	0.71	-139	10.48	3.342	76	-15.70	0.164	5	0.40	-110	13.09
4.0	0.67	-170	8.68	2.716	52	-15.44	0.169	-12	0.34	-138	12.06
5.0	0.66	162	7.24	2.302	30	-15.44	0.169	-27	0.31	-162	11.34
6.0	0.66	137	6.02	2.000	10	-15.60	0.166	-41	0.29	173	10.81
7.0	0.68	113	4.78	1.734	-10	-15.92	0.160	-55	0.28	146	10.35
8.0	0.70	92	3.51	1.498	-29	-16.59	0.148	-67	0.29	121	8.89
9.0	0.72	73	2.39	1.316	-47	-17.20	0.138	-77	0.32	103	7.33
10.0	0.74	56	1.51	1.190	-64	-17.46	0.134	-86	0.37	87	6.93
11.0	0.78	39	0.44	1.052	-83	-17.86	0.128	-97	0.42	66	6.66
12.0	0.82	23	-0.73	0.919	-100	-18.42	0.120	-106	0.47	47	6.22
13.0	0.83	10	-2.17	0.779	-117	-19.33	0.108	-115	0.52	28	4.93
14.0	0.85	-2	-3.54	0.665	-132	-20.00	0.100	-121	0.57	11	3.95
15.0	0.87	-16	-4.84	0.573	-147	-20.45	0.095	-129	0.63	0	3.58
16.0	0.88	-30	-6.16	0.492	-161	-20.82	0.091	-136	0.68	-12	2.90
17.0	0.88	-39	-7.51	0.421	-176	-21.11	0.088	-145	0.71	-26	1.98
18.0	0.89	-50	-9.07	0.352	173	-21.83	0.081	-151	0.75	-37	1.24

ATF-38143 Typical Noise Parameters

$V_{DS} = 2\text{ V}$, $I_{DS} = 5\text{ mA}$

Freq. GHz	F_{min} dB	Γ_{opt}		$R_n/50$ -	G_a dB
		Mag.	Ang.		
0.5	0.18	0.69	14	0.25	23.0
0.9	0.21	0.69	26	0.23	20.5
1.0	0.22	0.68	27	0.22	19.8
1.5	0.26	0.68	44	0.20	17.1
1.8	0.29	0.66	59	0.17	16.0
2.0	0.32	0.65	61	0.17	15.4
2.5	0.40	0.62	80	0.14	14.3
3.0	0.48	0.59	98	0.11	13.1
4.0	0.60	0.50	127	0.08	10.8
5.0	0.70	0.49	163	0.04	9.8
6.0	0.84	0.51	-169	0.04	8.7
7.0	0.96	0.53	-140	0.09	7.7
8.0	1.12	0.54	-111	0.20	6.8
9.0	1.27	0.59	-88	0.36	6.1
10.0	1.38	0.62	-68	0.60	6.0

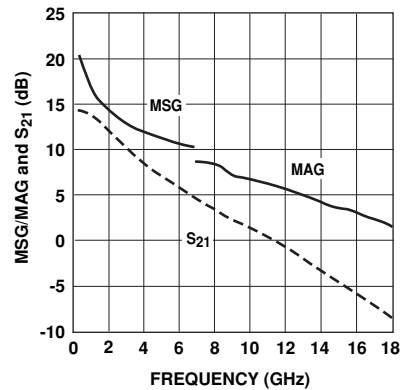

Figure 18. MSG/MAG and $|S_{21}|^2$ vs. Frequency at 2 V, 5 mA.

Notes:

- F_{min} values are based on a set of 16 noise figure measurements made at 16 different impedances using an ATN NP5 test system. From these measurements a true F_{min} is calculated. Refer to the noise parameter application section for more information.
- S and noise parameters are measured on a microstrip line made on 0.025 inch thick alumina carrier. The input reference plane is at the end of the gate lead. The output reference plane is at the end of the drain lead. The parameters include the effect of four plated through via holes connecting source landing pads on top of the test carrier to the microstrip ground plane on the bottom side of the carrier. Two 0.020 inch diameter via holes are placed within 0.010 inch from each source lead contact point, one via on each side of that point.

ATF-38143 Typical Scattering Parameters, $V_{DS} = 2\text{ V}$, $I_{DS} = 10\text{ mA}$

Freq. (GHz)	S_{11}			S_{21}			S_{12}		S_{22}		MSG/MAG (dB)
	Mag.	Ang.	dB	Mag.	Ang.	dB	Mag.	Ang.	Mag.	Ang.	
0.5	0.97	-29	17.41	7.423	158	-27.74	0.041	72	0.53	-26	22.58
0.8	0.93	-47	17.00	7.081	145	-24.01	0.063	61	0.51	-40	20.51
1.0	0.91	-58	16.69	6.834	136	-22.50	0.075	55	0.48	-50	19.60
1.5	0.83	-85	15.69	6.086	117	-20.00	0.100	40	0.42	-72	17.84
1.8	0.78	-100	15.02	5.634	107	-19.17	0.110	33	0.39	-85	17.09
2.0	0.76	-109	14.57	5.350	100	-18.71	0.116	28	0.37	-94	16.64
2.5	0.71	-131	13.38	4.665	86	-17.99	0.126	18	0.33	-114	15.68
3.0	0.68	-150	12.22	4.083	73	-17.65	0.131	9	0.31	-132	14.94
4.0	0.65	180	10.24	3.251	50	-17.27	0.137	-5	0.28	-163	13.75
5.0	0.65	153	8.68	2.716	30	-17.08	0.140	-18	0.28	172	12.88
6.0	0.66	129	7.35	2.330	11	-16.95	0.142	-30	0.28	147	12.15
7.0	0.68	107	6.03	2.003	-9	-16.95	0.142	-42	0.29	122	11.49
8.0	0.71	87	4.72	1.722	-27	-17.27	0.137	-53	0.32	99	9.09
9.0	0.73	68	3.57	1.509	-43	-17.46	0.134	-62	0.35	83	7.94
10.0	0.75	53	2.71	1.366	-60	-17.27	0.137	-72	0.40	70	7.55
11.0	0.79	36	1.61	1.204	-78	-17.39	0.135	-83	0.45	52	7.27
12.0	0.82	20	0.47	1.055	-94	-17.65	0.131	-94	0.50	35	6.84
13.0	0.84	8	-0.93	0.898	-110	-18.34	0.121	-104	0.54	17	5.72
14.0	0.85	-4	-2.24	0.773	-125	-18.86	0.114	-112	0.59	2	4.77
15.0	0.87	-18	-3.45	0.672	-140	-19.17	0.110	-122	0.63	-8	4.42
16.0	0.88	-31	-4.63	0.587	-153	-19.49	0.106	-131	0.67	-19	3.85
17.0	0.88	-41	-5.81	0.512	-167	-19.74	0.103	-141	0.70	-32	3.03
18.0	0.89	-51	-7.27	0.433	-179	-20.54	0.094	-148	0.74	-41	2.34

ATF-38143 Typical Noise Parameters

$V_{DS} = 2\text{ V}$, $I_{DS} = 10\text{ mA}$

Freq. GHz	F_{min} dB	Γ_{opt}		$R_{n/50}$ -	G_a dB
		Mag.	Ang.		
0.5	0.18	0.66	13	0.17	24.1
0.9	0.19	0.64	22	0.16	21.0
1.0	0.20	0.63	26	0.15	20.4
1.5	0.23	0.60	43	0.14	17.9
1.8	0.25	0.57	60	0.12	17.0
2.0	0.28	0.56	67	0.12	16.1
2.5	0.32	0.54	81	0.10	15.2
3.0	0.39	0.52	98	0.08	13.9
4.0	0.52	0.44	129	0.06	11.9
5.0	0.65	0.44	166	0.04	10.8
6.0	0.75	0.45	-165	0.04	9.6
7.0	0.84	0.48	-135	0.08	8.7
8.0	0.95	0.51	-106	0.16	7.7
9.0	1.10	0.55	-84	0.29	7.0
10.0	1.20	0.56	-65	0.46	6.8

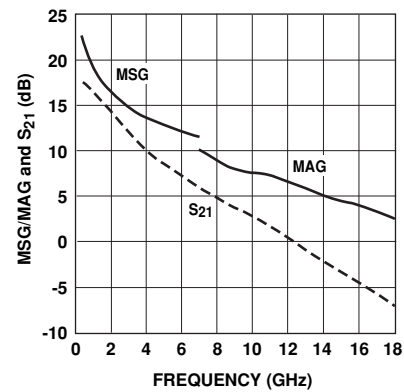

Figure 19. MSG/MAG and $|S_{21}|^2$ vs. Frequency at 2 V, 10 mA.

Notes:

- F_{min} values are based on a set of 16 noise figure measurements made at 16 different impedances using an ATN NP5 test system. From these measurements a true F_{min} is calculated. Refer to the noise parameter application section for more information.
- S and noise parameters are measured on a microstrip line made on 0.025 inch thick alumina carrier. The input reference plane is at the end of the gate lead. The output reference plane is at the end of the drain lead. The parameters include the effect of four plated through via holes connecting source landing pads on top of the test carrier to the microstrip ground plane on the bottom side of the carrier. Two 0.020 inch diameter via holes are placed within 0.010 inch from each source lead contact point, one via on each side of that point.

ATF-38143 Typical Scattering Parameters, $V_{DS} = 2\text{ V}$, $I_{DS} = 20\text{ mA}$

Freq. (GHz)	S_{11}			S_{21}			S_{12}		S_{22}		MSG/MAG (dB)
	Mag.	Ang.	dB	Mag.	Ang.	dB	Mag.	Ang.	Mag.	Ang.	
0.5	0.96	-33	19.50	9.436	155	-28.87	0.036	71	0.39	-33	24.18
0.8	0.91	-53	18.94	8.850	141	-25.19	0.055	60	0.37	-50	22.07
1.0	0.88	-65	18.51	8.425	132	-23.74	0.065	54	0.35	-63	21.13
1.5	0.79	-93	17.23	7.269	113	-21.41	0.085	41	0.31	-90	19.32
1.8	0.75	-109	16.41	6.616	103	-20.63	0.093	34	0.29	-106	18.52
2.0	0.73	-119	15.88	6.220	97	-20.26	0.097	30	0.29	-116	18.07
2.5	0.68	-140	14.52	5.321	83	-19.58	0.105	21	0.27	-139	17.05
3.0	0.66	-159	13.26	4.604	70	-19.09	0.111	14	0.27	-157	16.18
4.0	0.64	172	11.16	3.616	49	-18.49	0.119	2	0.28	174	14.83
5.0	0.64	147	9.52	2.992	30	-17.99	0.126	-9	0.29	151	13.76
6.0	0.66	124	8.12	2.548	11	-17.52	0.133	-20	0.31	129	12.82
7.0	0.68	103	6.77	2.179	-8	-17.33	0.136	-32	0.34	107	11.08
8.0	0.71	83	5.41	1.864	-25	-17.39	0.135	-43	0.37	87	9.34
9.0	0.73	65	4.25	1.632	-41	-17.27	0.137	-53	0.40	73	8.33
10.0	0.76	50	3.39	1.478	-57	-16.95	0.142	-63	0.44	61	7.91
11.0	0.80	34	2.27	1.299	-74	-16.89	0.143	-76	0.50	44	7.63
12.0	0.83	18	1.11	1.136	-90	-17.14	0.139	-87	0.55	28	7.20
13.0	0.85	6	-0.26	0.971	-106	-17.72	0.130	-98	0.58	11	6.20
14.0	0.86	-5	-1.51	0.840	-120	-18.13	0.124	-107	0.62	-4	5.32
15.0	0.88	-19	-2.69	0.734	-134	-18.42	0.120	-118	0.67	-13	5.01
16.0	0.89	-32	-3.80	0.646	-147	-18.79	0.115	-127	0.69	-24	4.34
17.0	0.89	-42	-4.91	0.568	-161	-19.02	0.112	-138	0.71	-36	3.57
18.0	0.90	-52	-6.29	0.485	-173	-19.83	0.102	-146	0.74	-46	2.94

ATF-38143 Typical Noise Parameters

$V_{DS} = 2\text{ V}$, $I_{DS} = 20\text{ mA}$

Freq. GHz	F_{min} dB	Γ_{opt}		$R_{n/50}$ -	G_a dB
		Mag.	Ang.		
0.5	0.15	0.71	13	0.13	24.8
0.9	0.16	0.68	22	0.12	21.4
1.0	0.16	0.66	26	0.12	21.0
1.5	0.18	0.60	43	0.09	19.0
1.8	0.20	0.55	55	0.09	18.0
2.0	0.22	0.51	68	0.09	16.9
2.5	0.28	0.48	82	0.08	15.5
3.0	0.33	0.46	100	0.06	14.7
4.0	0.45	0.37	133	0.05	12.6
5.0	0.56	0.39	172	0.04	11.4
6.0	0.65	0.40	-159	0.04	10.2
7.0	0.72	0.44	-129	0.08	9.3
8.0	0.82	0.48	-100	0.15	8.3
9.0	0.90	0.52	-79	0.26	7.5
10.0	1.00	0.60	-61	0.40	7.3

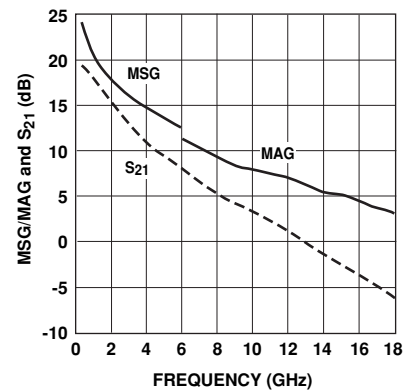

Figure 20. MSG/MAG and $|S_{21}|^2$ vs. Frequency at 2 V, 20 mA.

Notes:

- F_{min} values are based on a set of 16 noise figure measurements made at 16 different impedances using an ATN NP5 test system. From these measurements a true F_{min} is calculated. Refer to the noise parameter application section for more information.
- S and noise parameters are measured on a microstrip line made on 0.025 inch thick alumina carrier. The input reference plane is at the end of the gate lead. The output reference plane is at the end of the drain lead. The parameters include the effect of four plated through via holes connecting source landing pads on top of the test carrier to the microstrip ground plane on the bottom side of the carrier. Two 0.020 inch diameter via holes are placed within 0.010 inch from each source lead contact point, one via on each side of that point.

Noise Parameter Applications Information

F_{min} values at 2 GHz and higher are based on measurements while the F_{min} s below 2 GHz have been extrapolated. The F_{min} values are based on a set of 16 noise figure measurements made at 16 different impedances using an ATN NP5 test system. From these measurements, a true F_{min} is calculated. F_{min} represents the true minimum noise figure of the device when the device is presented with an impedance matching network that transforms the source impedance, typically 50Ω , to an impedance represented by the reflection coefficient Γ_o . The designer must design a matching network that will present Γ_o to the device with minimal associated circuit losses. The noise figure of the completed amplifier is equal to the noise figure of the device plus the losses of the matching network preceding the device. The noise figure of the device is equal to F_{min} only when the device is presented with Γ_o . If the reflection coefficient of the matching network is other than Γ_o , then the noise figure of the device will be greater than F_{min} based on the following equation.

$$NF = F_{min} + \frac{4 R_n}{Z_o} \frac{|\Gamma_s - \Gamma_o|^2}{(|1 + \Gamma_o|^2)(1 - |\Gamma_s|^2)}$$

Where R_n/Z_o is the normalized noise resistance, Γ_o is the optimum reflection coefficient required to produce F_{min} and Γ_s is the reflection coefficient of the source impedance actually presented to the device. The losses of the matching networks are non-zero and they will also add to the noise figure of the device creating a higher amplifier noise figure. The losses of the matching networks are related to the Q of the components and associated printed circuit board loss. Γ_o is typically fairly low at higher frequencies and increases as frequency is lowered. Larger gate width devices will typically have a lower Γ_o as compared to narrower gate width devices.

Typically for FETs, the higher Γ_o usually infers that an impedance much higher than 50Ω is required for the device to produce F_{min} . At VHF frequencies and even lower L Band frequencies, the required impedance can be in the vicinity of several thousand ohms. Matching to such a high impedance requires very hi-Q components in order to minimize circuit losses. As an example at 900 MHz, when air-wound coils ($Q > 100$) are used for matching networks, the loss can still be up to 0.25 dB which will add directly to the noise figure of the device. Using multi-layer molded inductors with Qs in the 30 to 50 range results in additional loss over the air-wound coil. Losses as high as 0.5 dB or greater add to the typical 0.15 dB F_{min} of the device creating an amplifier noise figure of nearly 0.65 dB. A discussion concerning calculated and measured circuit losses and their effect on amplifier noise figure is covered in Avago Application 1085.

ATF-38143 SC70 4 Lead, High Frequency Nonlinear Model

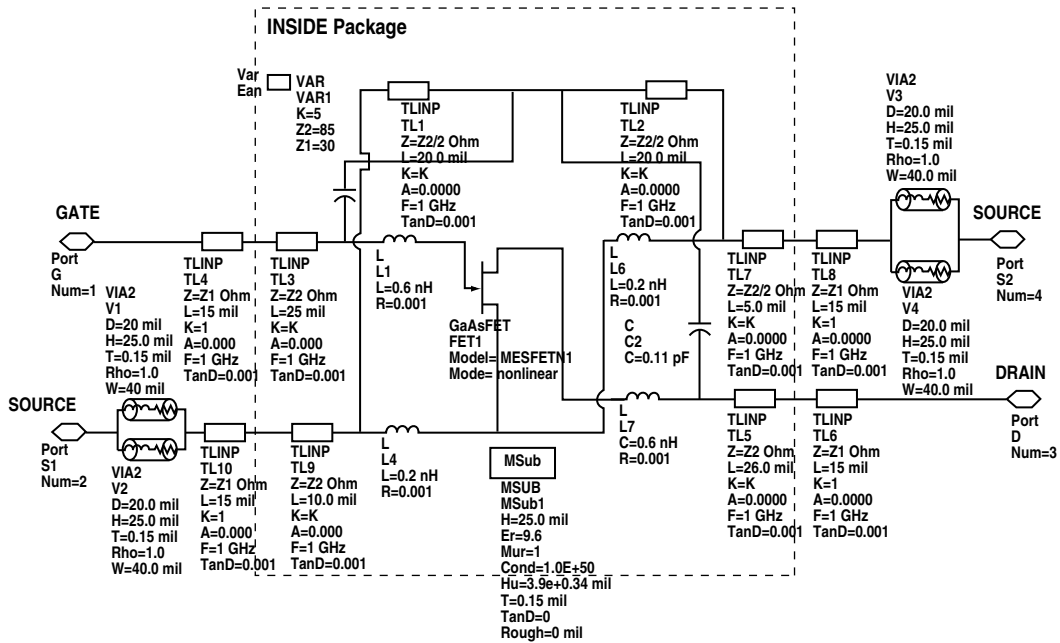

The vias are not part of the model as such. They are only included to account for the source vias in the test fixture.

ATF-38143 Die Model

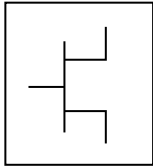

Statz Model
MESFETM1

NFET=yes
PFET=no
Vto=-0.75
Beta=0.3
Lambda=0.07
Alpha=4
B=0.8
Tnom=27
Idstc=
Vbi=0.7
Tau=
Betatce=
Delta1=
Delta2=
Gscap=3

Cgs=0.997 pF
Gdcap=3
Cgd=0.176 pF
Rgd=0.195
Tqm=
Vmax=
Fc=
Rd=0.084
Rg=0.264
Rs=0.054
Ld=0.0014 nH
Lg=0.0883 nH
Ls=0.001 nH
Cds=0.0911 pF
Crf=0.0936

Rc=137
Gsfwd=1
Gsrev=0
Gdfwd=1
Gdrev=0
Vjr=1
Is=1 nA
Ir=1 nA
Imax=0.1
Xti=
N=
Eg=
Vbr=
Vtotc=
Rin=

Taumd1=no
Fnc=1E6
R=0.17
C=0.2
P=1
wVgfwd=
wBvgs=
wBvgd=
wBvds=
wldsmax=
wPmax=
All Params=

Part Number Ordering Information

Part Number	No. of Devices	Container
ATF-38143-TR1G	3000	7" Reel
ATF-38143-TR2G	10000	13" Reel
ATF-38143-BLKG	100	antisatic bag

Package Dimensions

SC70 4L / SOT-343

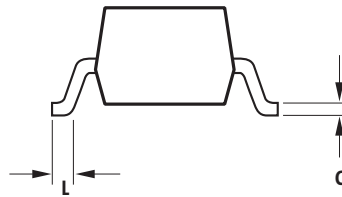
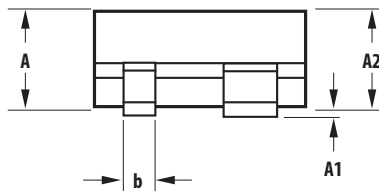
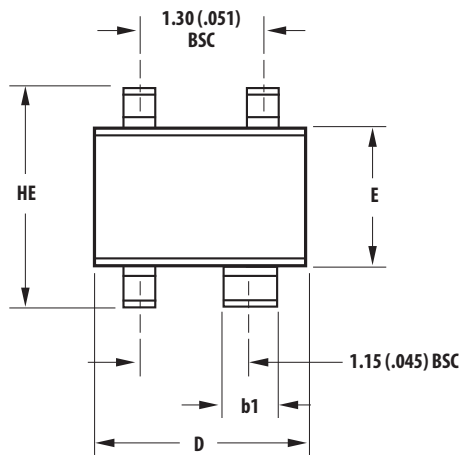

SYMBOL	DIMENSIONS (mm)	
	MIN.	MAX.
E	1.15	1.35
D	1.85	2.25
HE	1.80	2.40
A	0.80	1.10
A2	0.80	1.00
A1	0.00	0.10
b	0.15	0.40
b1	0.55	0.70
c	0.10	0.20
L	0.10	0.46

Recommended PCB Pad Layout for Avago's SC70 4L/SOT-343 Products

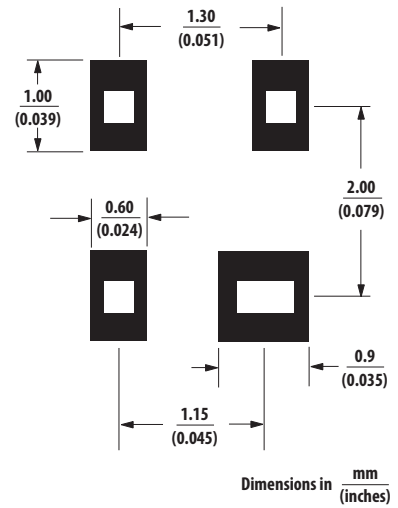

NOTES:

1. All dimensions are in mm.
2. Dimensions are inclusive of plating.
3. Dimensions are exclusive of mold flash & metal burr.
4. All specifications comply to EIAJ SC70.
5. Die is facing up for mold and facing down for trim/form, ie: reverse trim/form.
6. Package surface to be mirror finish.

Device Orientation

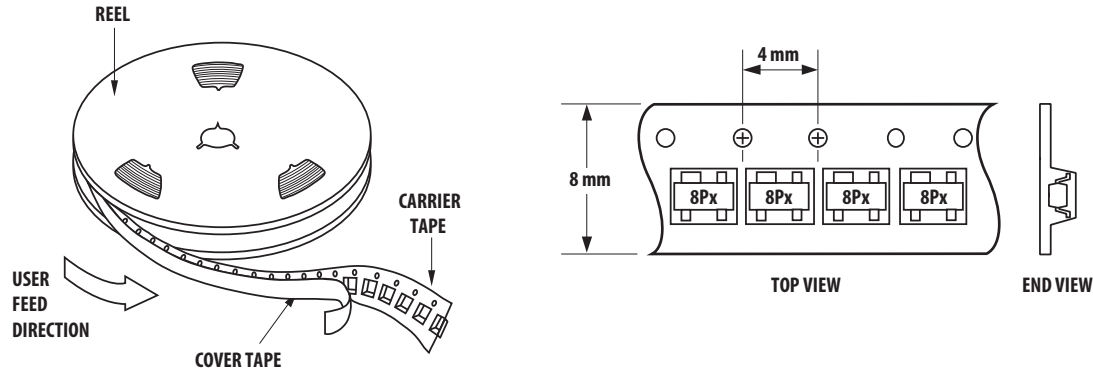

Tape Dimensions for Outline 4T

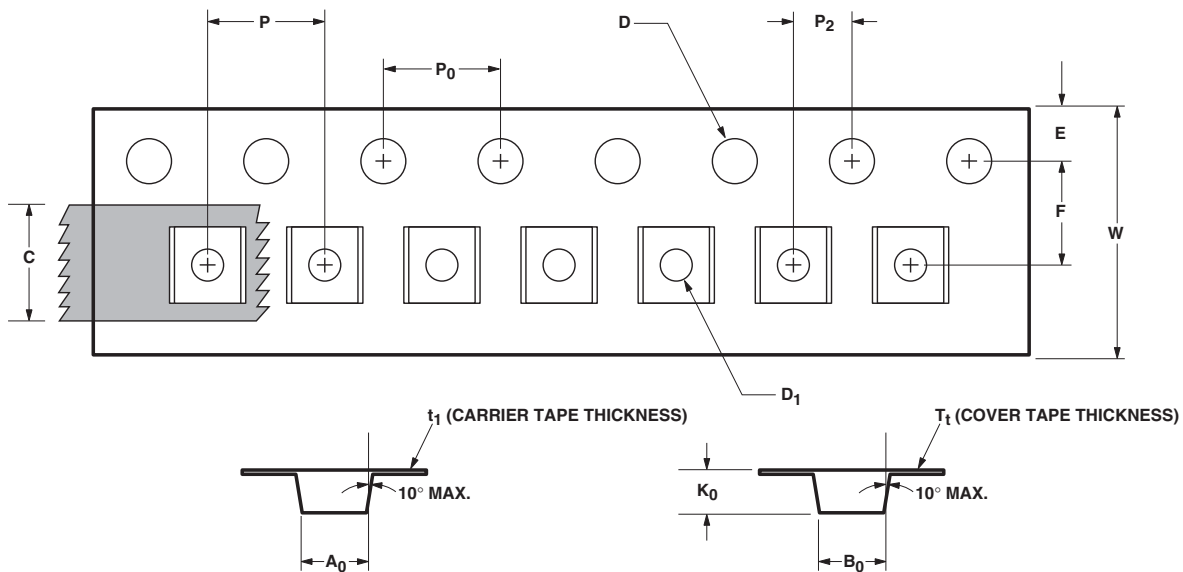

	DESCRIPTION	SYMBOL	SIZE (mm)	SIZE (INCHES)
CAVITY	LENGTH	A_0	2.40 ± 0.10	0.094 ± 0.004
	WIDTH	B_0	2.40 ± 0.10	0.094 ± 0.004
	DEPTH	K_0	1.20 ± 0.10	0.047 ± 0.004
	PITCH	P	4.00 ± 0.10	0.157 ± 0.004
	BOTTOM HOLE DIAMETER	D_1	$1.00 + 0.25$	$0.039 + 0.010$
	PERFORATION	DIAMETER	D	1.55 ± 0.10
PITCH		P_0	4.00 ± 0.10	0.157 ± 0.004
POSITION		E	1.75 ± 0.10	0.069 ± 0.004
CARRIER TAPE	WIDTH	W	$8.00 + 0.30 - 0.10$	$0.315 + 0.012$
	THICKNESS	t_1	0.254 ± 0.02	0.0100 ± 0.0008
COVER TAPE	WIDTH	C	5.40 ± 0.10	$0.205 + 0.004$
	TAPE THICKNESS	T_1	0.062 ± 0.001	0.0025 ± 0.0004
DISTANCE	CAVITY TO PERFORATION (WIDTH DIRECTION)	F	3.50 ± 0.05	0.138 ± 0.002
	CAVITY TO PERFORATION (LENGTH DIRECTION)	P_2	2.00 ± 0.05	0.079 ± 0.002

For product information and a complete list of distributors, please go to our web site: www.avagotech.com

Avago, Avago Technologies, and the A logo are trademarks of Avago Technologies in the United States and other countries. Data subject to change. Copyright © 2005-2012 Avago Technologies. All rights reserved. Obsoletes 5989-3745EN AV02-1443EN - June 8, 2012

Avago
TECHNOLOGIES