

### Description

The AU0541D5 is a bi-directional TVS diode, utilizing leading monolithic silicon technology to provide fast response time and low ESD clamping voltage, making this device an ideal solution for protecting voltage sensitive data and power line. The AU0541D5 complies with the IEC 61000-4-2 (ESD) with  $\pm 30$  kV air and  $\pm 30$  kV contact discharge. It is assembled into an ultra-small SOD-523 lead-free package. The small size and high ESD surge protection make AU0541D5 an ideal choice to protect cell phone, digital cameras, audio players and many other portable applications.

### Features

- Protects one data or power line
- Ultra low leakage: nA level
- Operating voltage: 5V
- Low clamping voltage
- Complies with following standards:
  - IEC 61000-4-2 (ESD) immunity test
    - Air discharge:  $\pm 30$ kV
    - Contact discharge:  $\pm 30$ kV
  - IEC61000-4-5 (Lightning) 15A (8/20 $\mu$ s)
- RoHS Compliant

### Mechanical Characteristics

- Package: SOD-523
- Lead Finish: Matte Tin
- Case Material: “Green” Molding Compound.
- Moisture Sensitivity: Level 3 per J-STD-020
- Terminal Connections: See Diagram Below
- Marking Information: See Below

### Applications

- Cellular Handsets and Accessories
- Personal Digital Assistants
- Notebooks and Handhelds
- Portable Instrumentation
- Digital Cameras
- Peripherals
- Audio Players
- Keypads, Side Keys, LCD Displays

### Marking Information



D4 = Device Marking Code  
 Dot denotes Pin1

### Dimensions and Pin Configuration

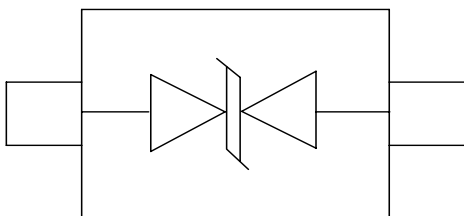

Circuit and Pin Schematic

### Ordering Information

Part Number	Packaging	Reel Size
AU0541D5	3000/Tape & Reel	7 inch

**Absolute Maximum Ratings (T<sub>A</sub>=25°C unless otherwise specified)**

Parameter	Symbol	Value	Unit
Peak Pulse Power (8/20μs)	Ppk	200	W
Peak Pulse Current (8/20μs)	I <sub>PP</sub>	15	A
ESD per IEC 61000-4-2 (Air)	V <sub>ESD</sub>	±30	kV
ESD per IEC 61000-4-2 (Contact)		±30	
Operating Temperature Range	T <sub>J</sub>	-55 to +125	°C
Storage Temperature Range	T <sub>stg</sub>	-55 to +150	°C

**Electrical Characteristics (T<sub>A</sub>=25°C unless otherwise specified)**

Parameter	Symbol	Min	Typ	Max	Unit	Test Condition
Reverse Working Voltage	V <sub>RWM</sub>			5	V	
Breakdown Voltage	V <sub>BR</sub>	6		8	V	I <sub>T</sub> = 1mA
Reverse Leakage Current	I <sub>R</sub>			0.2	μA	V <sub>RWM</sub> = 5V
Clamping Voltage	V <sub>C</sub>			8	V	I <sub>PP</sub> = 1A
Clamping Voltage	V <sub>C</sub>			14	V	I <sub>PP</sub> = 15A
Junction Capacitance	C <sub>J</sub>		30	50	pF	V <sub>R</sub> = 0V, f = 1MHz

**Typical Performance Characteristics ( $T_A=25^\circ\text{C}$  unless otherwise Specified)**

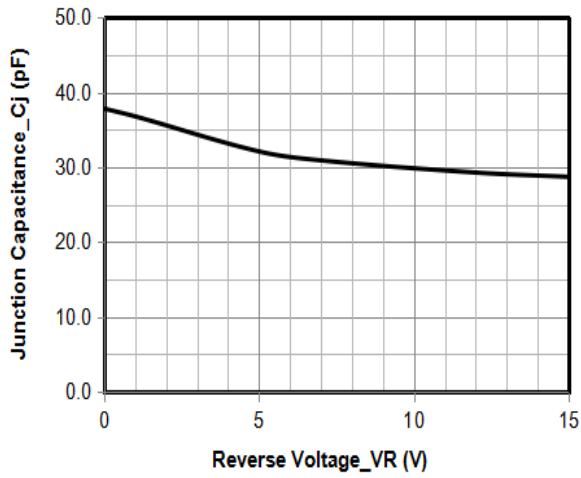

**Junction Capacitance vs. Reverse Voltage**

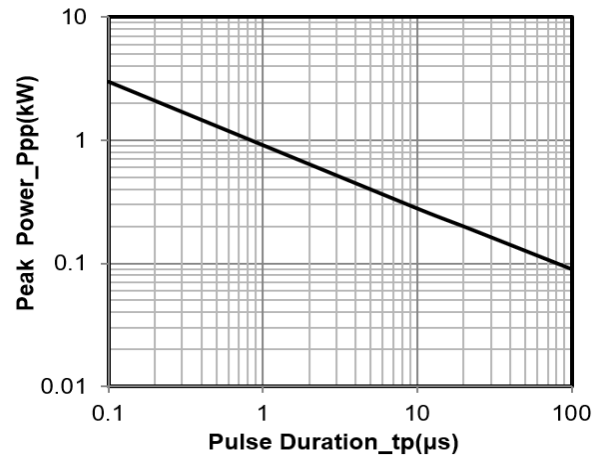

**Peak Pulse Power vs. Pulse Time**

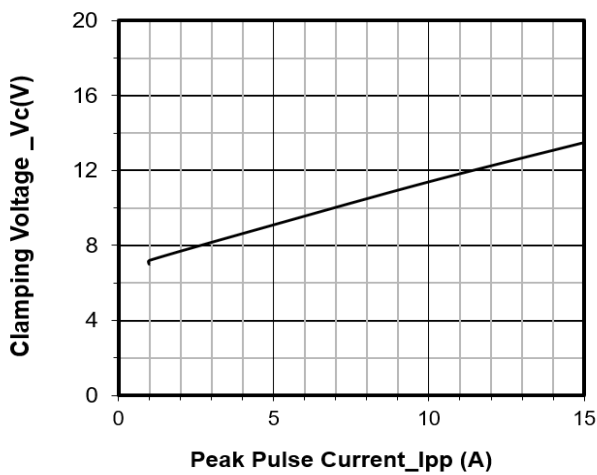

**Clamping Voltage vs. Peak Pulse Current ( $t_p = 8/20\mu\text{s}$ )**

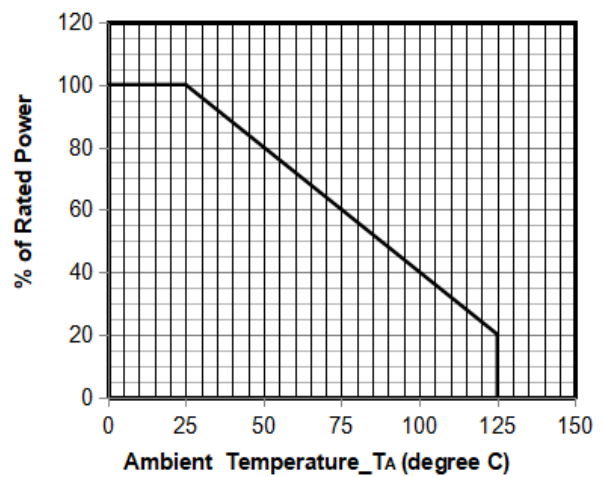

**Power Derating Curve**

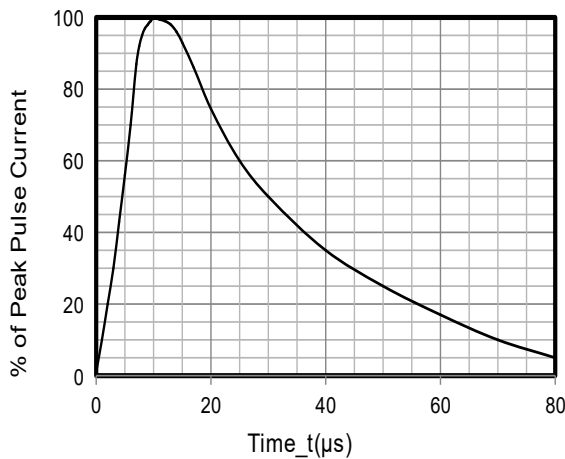

**8 X 20μs Pulse Waveform**

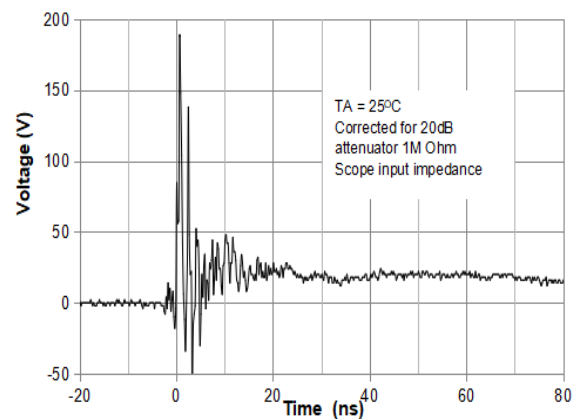

**ESD Clamping Voltage  
8 kV Contact per IEC61000-4-2**

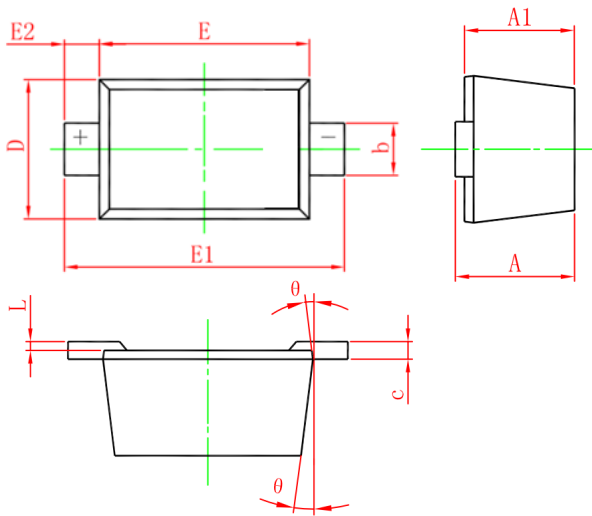
**SOD-523 Package Outline Drawing**

SYM	DIMENSIONS					
	MILLIMETERS			INCHES		
	MIN	NOM	MAX	MIN	NOM	MAX
A	0.51	--	0.77	0.020	--	0.031
A1	0.50	--	0.70	0.020	--	0.028
b	0.25	--	0.35	0.010	--	0.014
c	0.08	--	0.15	0.003	--	0.006
D	0.75	--	0.85	0.030	--	0.033
E	1.10	--	1.30	0.043	--	0.051
E1	1.50	--	1.70	0.059		0.067
E2	0.20REF			0.008REF		
L	0.01	--	0.07	0.001	--	0.003
Θ	7° REF			7° REF		

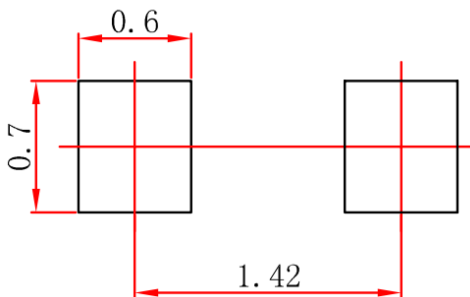
**Suggested Land Pattern**

Unit: mm

**Contact Information**

Applied Power Microelectronics Co., Ltd.

 Website: <http://www.appliedpowermicro.com>

 Email: [sales@appliedpowermicro.com](mailto:sales@appliedpowermicro.com)

Phone: +86 (0519) 8399 3606