

Description

The AU0771D3 is an uni-directional high power TVS diode, utilizing leading monolithic silicon technology to provide fast response time and low ESD clamping voltage, making this device an ideal solution for protecting voltage sensitive data and power line. The AU0771D3 complies with the IEC 61000-4-2 (ESD) with $\pm 30\text{kV}$ air and $\pm 30\text{kV}$ contact discharge. It is assembled into an ultra-small lead-free SOD-323 package. The small size and high ESD surge protection make AU0771D3 an ideal choice to protect cell phone, digital cameras, audio players and many other portable applications.

Features

- Small SOD-323 package
- Protects one data or power line
- Operating Voltage: 7V
- High peak pulse current capability
- Ultra low clamping voltage
- Complies with following standards:
 - IEC 61000-4-2 (ESD) immunity test
 - Air discharge: $\pm 30\text{kV}$
 - Contact discharge: $\pm 30\text{kV}$
 - IEC61000-4-5 (Lightning) 120A (8/20 μs)
- RoHS Compliant

Mechanical Characteristics

- Package: SOD-323
- Lead Finish: Matte Tin
- Case Material: "Green" Molding Compound.
- Moisture Sensitivity: Level 3 per J-STD-020
- Terminal Connections: See Diagram Below
- Marking Information: See Below

Applications

- Mobile Phones and Accessories
- Battery Protection
- Power Supply Protection
- Hand Held Portable Applications
- Peripherals

Marking Information

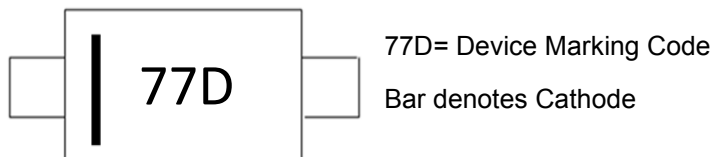

Dimensions and Pin Configuration

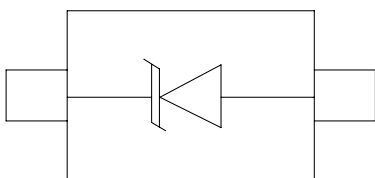

SOD-323 (Top View)

Circuit Diagram

Ordering Information

Part Number	Marking	Packaging	Reel Size
AU0771D3	47D	3000/Tape & Reel	7 inch

Absolute Maximum Ratings ($T_A=25^{\circ}\text{C}$ unless otherwise specified)

Parameter	Symbol	Value	Unit
Peak Pulse Power (8/20 μs)	Ppk	2400	W
Peak Pulse Current (8/20 μs)	Ipp	120	A
ESD per IEC 61000-4-2 (Air)	VESD	± 30	kV
ESD per IEC 61000-4-2 (Contact)		± 30	
Operating Temperature Range	TJ	-55 to +125	$^{\circ}\text{C}$
Storage Temperature Range	Tstg	-55 to +150	$^{\circ}\text{C}$

Electrical Characteristics ($T_A=25^{\circ}\text{C}$ unless otherwise specified)

Parameter	Symbol	Min	Typ	Max	Unit	Test Condition
Reverse Working Voltage	VRWM			7	V	
Breakdown Voltage	VBR	8			V	$I_T = 1\text{mA}$
Reverse Leakage Current	I _R			1	μA	VRWM = 7V
Clamping Voltage	VC			11	V	IPP = 20A (8 x 20 μs pulse)
Clamping Voltage	VC			20	V	IPP = 120A (8 x 20 μs pulse)
Junction Capacitance	CJ			550	pF	VR = 0V, f = 1MHz

Typical Performance Characteristics ($T_A=25^\circ\text{C}$ unless otherwise Specified)

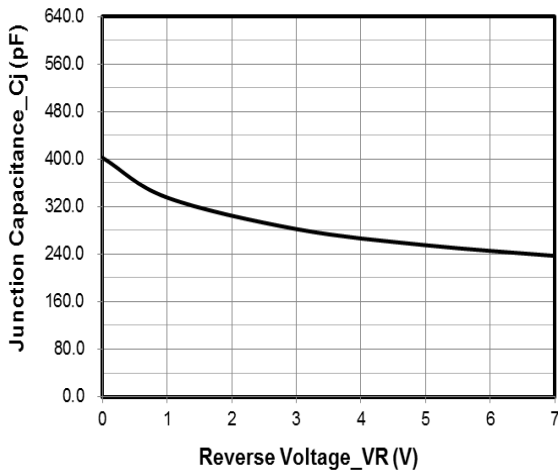

Junction Capacitance vs. Reverse Voltage

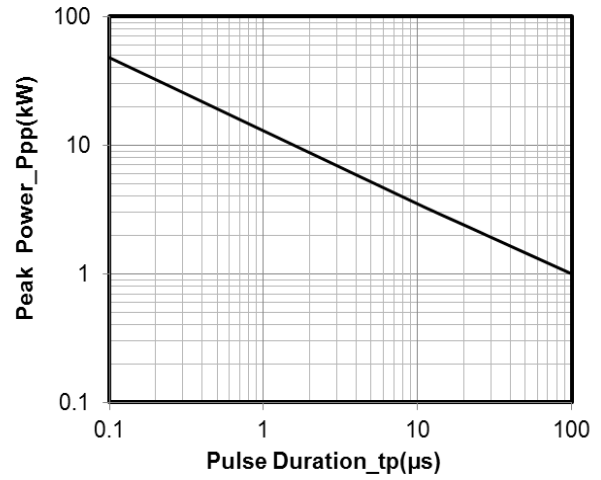

Peak Pulse Power vs. Pulse Time

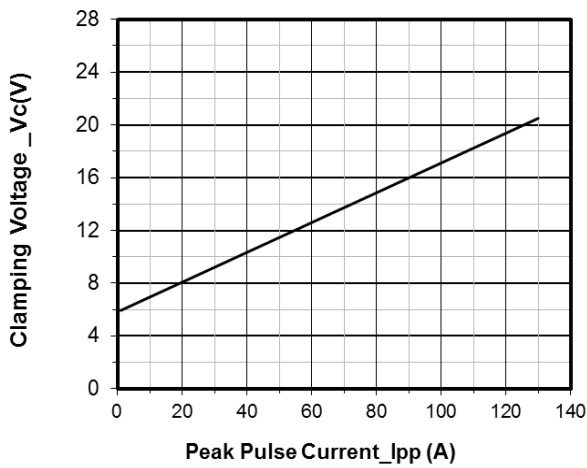

Clamping Voltage vs. Peak Pulse Current ($t_p = 8/20\mu\text{s}$)

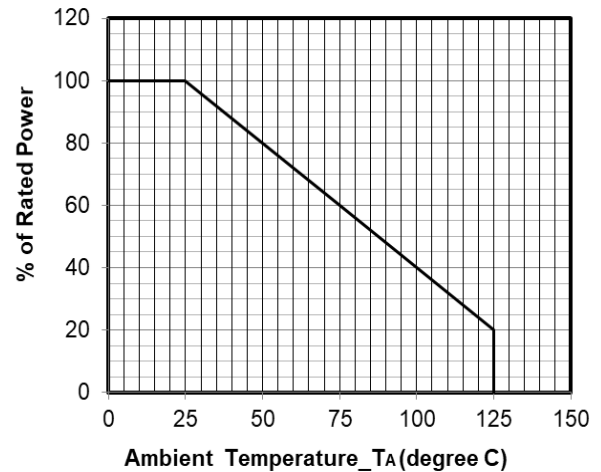

Power Derating Curve

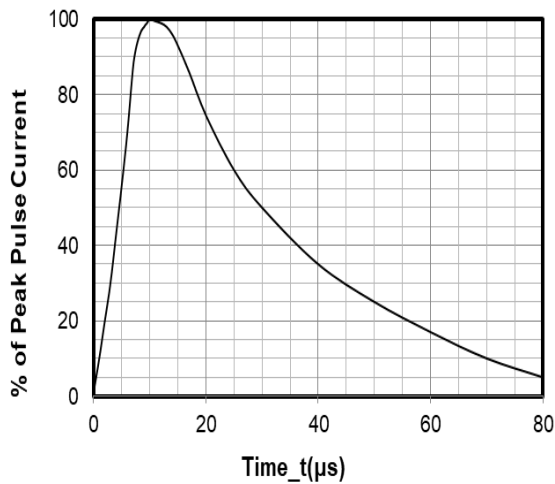

8 X 20 μs Pulse Waveform

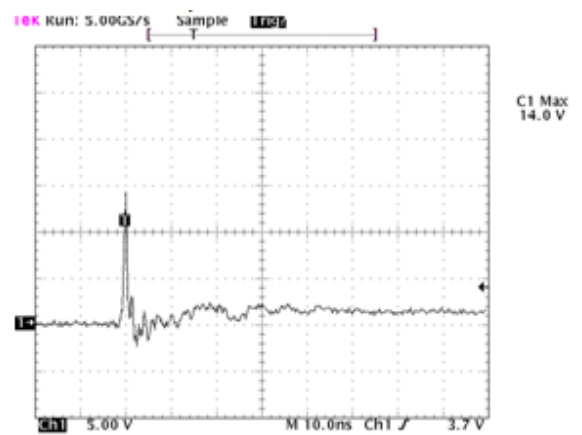

Note: Data is taken with a 10x attenuator

ESD Clamping Voltage

8 kV Contact per IEC61000-4-2

SOD-323 Package Outline Drawing

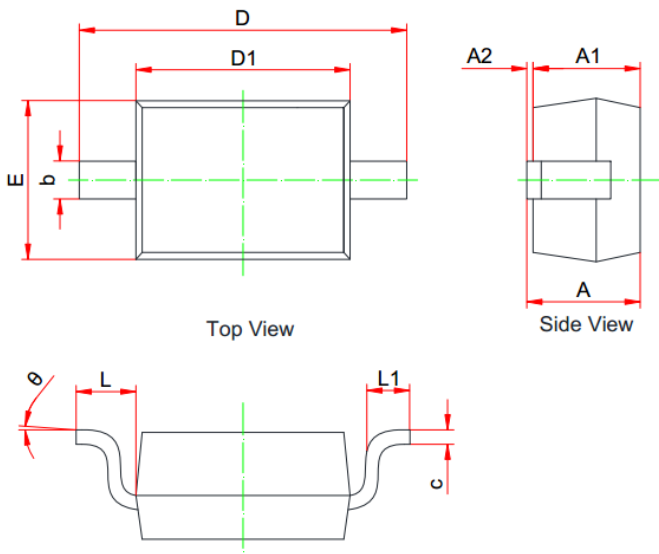

SYM	MILLIMETERS		
	MIN	NOM	MAX
A	0.800	--	1.100
A1	0.800	--	0.900
A2	0.000	--	0.100
b	0.250	--	0.400
c	0.080	--	0.177
D1	1.600	1.700	1.800
D	2.300	--	2.800
E	1.150	--	1.400
L	0.475REF		
L1	0.100	--	0.500
θ	0°	--	8°

Suggested Land Pattern



Unit: mm

Contact Information

Applied Power Microelectronics Co., Ltd.

Website: <http://www.appliedpowermicro.com>

Email: sales@appliedpowermicro.com

Phone: +86 (0519) 8399 3606