

Description

The AU3301D5 is a uni-directional TVS diode, utilizing leading monolithic silicon technology to provide fast response time and ultra low ESD clamping voltage, making this device an ideal solution for protecting voltage sensitive data and power line. The AU3301D5 complies with the IEC 61000-4-2 (ESD) with $\pm 30\text{kV}$ air and $\pm 30\text{kV}$ contact discharge. It is assembled into an ultra-small SOD-523 lead-free package. The small size and high ESD surge protection make AU3301D5 an ideal choice to protect cell phone, digital cameras, audio players and many other portable applications.

Features

- Protects one data line
- Ultra low leakage: nA level
- Operating voltage: 3.3V
- Ultra low clamping voltage
- Complies with following standards:
 - IEC 61000-4-2 (ESD) immunity test
 - Air discharge: $\pm 30\text{kV}$
 - Contact discharge: $\pm 30\text{kV}$
 - IEC61000-4-5 (Lightning) 15A (8/20 μs)
- RoHS Compliant

Mechanical Characteristics

- Package: SOD-523
- Lead Finish: Matte Tin
- Case Material: "Green" Molding Compound.
- Moisture Sensitivity: Level 3 per J-STD-020
- Terminal Connections: See Diagram Below
- Marking Information: See Below

Applications

- Cellular Handsets and Accessories
- Personal Digital Assistants
- Notebooks and Handhelds
- Portable Instrumentation
- Digital Cameras
- Peripherals
- Audio Players
- Keypads, Side Keys, LCD Displays

Marking Information

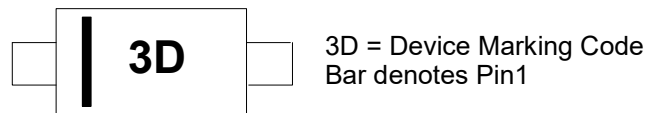

Dimensions and Pin Configuration

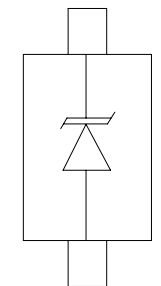
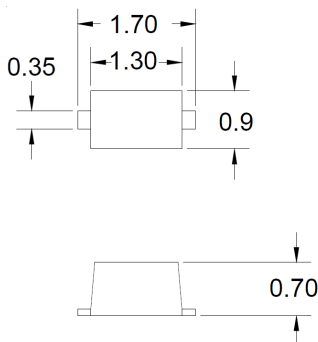

SOD-523 (Top View)

Package Dimensions

Circuit and Pin Schematic

Ordering Information

Part Number	Packaging	Reel Size
AU3301D5	3000/Tape & Reel	7 inch

Absolute Maximum Ratings ($T_A=25^\circ\text{C}$ unless otherwise specified)

Parameter	Symbol	Value	Unit
Peak Pulse Power (8/20 μs)	Ppk	150	W
Peak Pulse Current (8/20 μs)	Ipp	15	A
ESD per IEC 61000-4-2 (Air)	VESD	± 30	kV
ESD per IEC 61000-4-2 (Contact)		± 30	
Operating Temperature Range	TJ	-55 to +125	$^\circ\text{C}$
Storage Temperature Range	Tstg	-55 to +150	$^\circ\text{C}$

Electrical Characteristics ($T_A=25^\circ\text{C}$ unless otherwise specified)

Parameter	Symbol	Min	Typ	Max	Unit	Test Condition
Reverse Working Voltage	VRWM			3.3	V	
Breakdown Voltage	VBR	3.5			V	IT = 1mA
Reverse Leakage Current	IR			0.2	μA	VRWM = 3.3V
Clamping Voltage	VC			7	V	I _{PP} = 1A (8 x 20 μs pulse)
Clamping Voltage	VC			10	V	I _{PP} = 15A (8 x 20 μs pulse)
Junction Capacitance	CJ		20		pF	VR = 0V, f = 1MHz

Typical Performance Characteristics ($T_A=25^\circ\text{C}$ unless otherwise Specified)

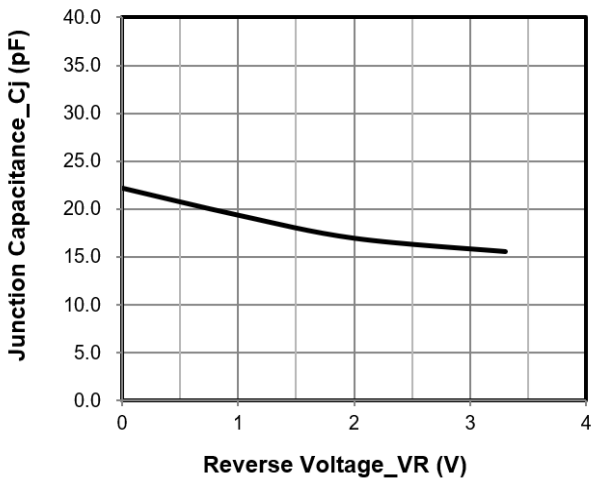

Junction Capacitance vs. Reverse Voltage

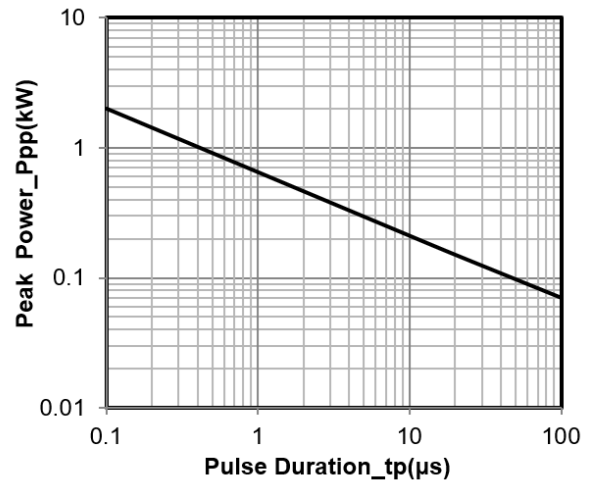

Peak Pulse Power vs. Pulse Time

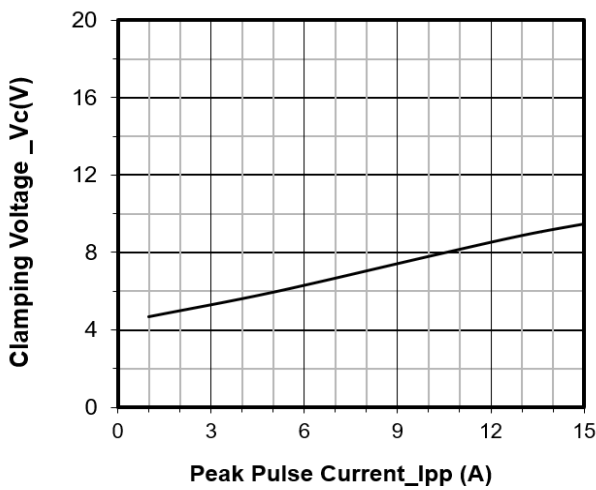

Clamping Voltage vs. Peak Pulse Current

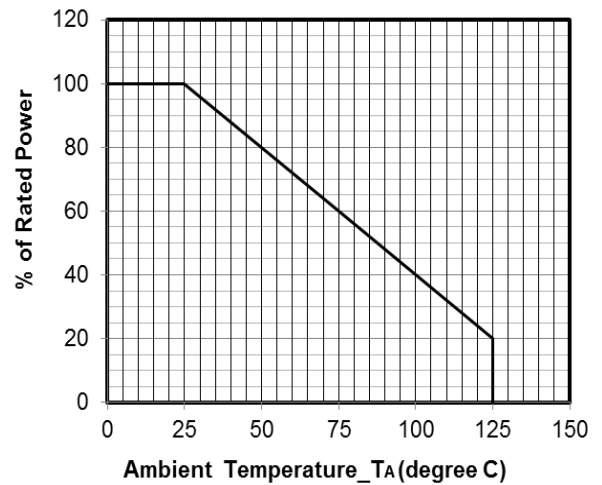

Power Derating Curve

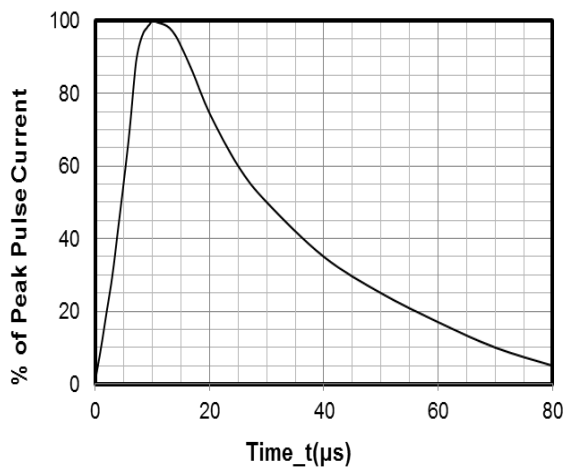

8 X 20μs Pulse Waveform

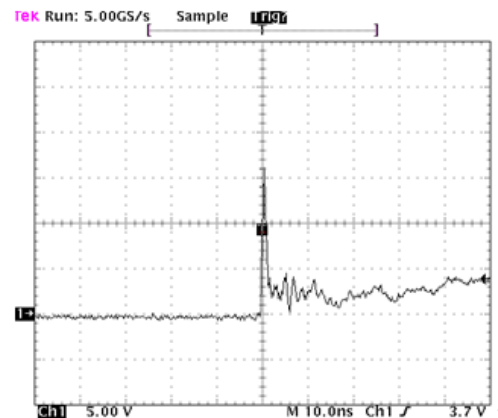

**Note: Data is taken with a 10x attenuator
ESD Clamping Voltage
8 kV Contact per IEC61000-4-2**

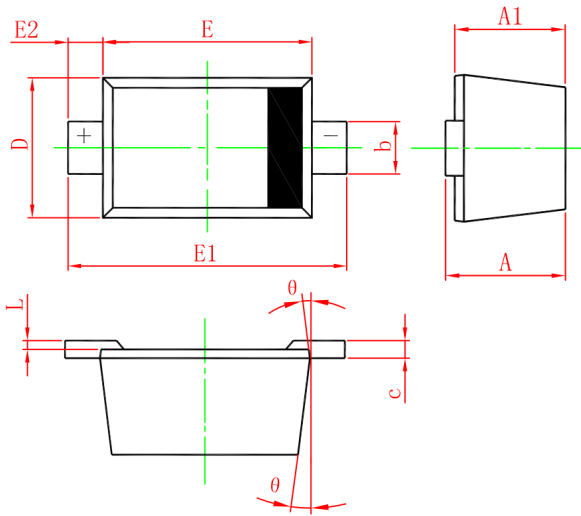
SOD-523 Package Outline Drawing

SY	DIMENSIONS					
	MILLIMETERS			INCHES		
	MIN	NOM	MAX	MIN	NOM	MAX
A	0.51	--	0.77	0.020	--	0.031
A1	0.50	--	0.70	0.020	--	0.028
b	0.25	--	0.35	0.010	--	0.014
c	0.08	--	0.15	0.003	--	0.006
D	0.75	--	0.85	0.030	--	0.033
E	1.10	--	1.30	0.043	--	0.051
E1	1.50	--	1.70	0.059		0.067
E2	0.20REF			0.008REF		
L	0.01	--	0.07	0.001	--	0.003
Θ	7° REF			7° REF		

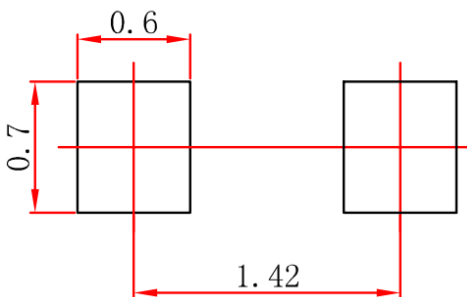
Suggested Land Pattern

单位 (mm)

Contact Information

Applied Power Microelectronics Co., Ltd.

 Website: <http://www.appliedpowermicro.com>

 Email: sales@appliedpowermicro.com

Phone: +86 (0519) 8399 3606