

# AUIPS2051L/AUIPS2052G

## INTELLIGENT POWER LOW SIDE SWITCH

### Features

- Over temperature shutdown
- Over current shutdown
- Active clamp
- Low current & logic level input
- ESD protection
- Optimized Turn On/Off for EMI
- Diagnostic on the input current

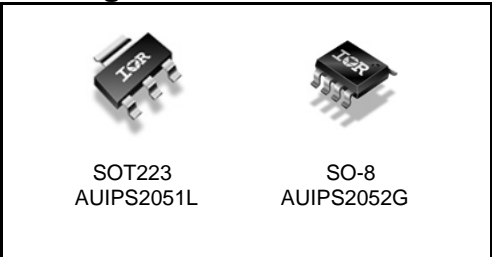
### Description

The AUIPS2051L/AUIPS2052G is a three terminal Intelligent Power Switch (IPS) that features a low side MOSFET with over-current, over-temperature, ESD protection and drain to source active clamp. The AUIPS2052 is a dual channel device while the AUIPS2051 is a single channel. This device offers protections and the high reliability required in harsh environments. The switch provides efficient protection by turning OFF the power MOSFET when the temperature exceeds 165°C or when the drain current reaches 1.8A. The device restarts once the input is cycled. A serial resistance connected to the input provides the diagnostic. The avalanche capability is significantly enhanced by the active clamp and covers most inductive load demagnetizations.

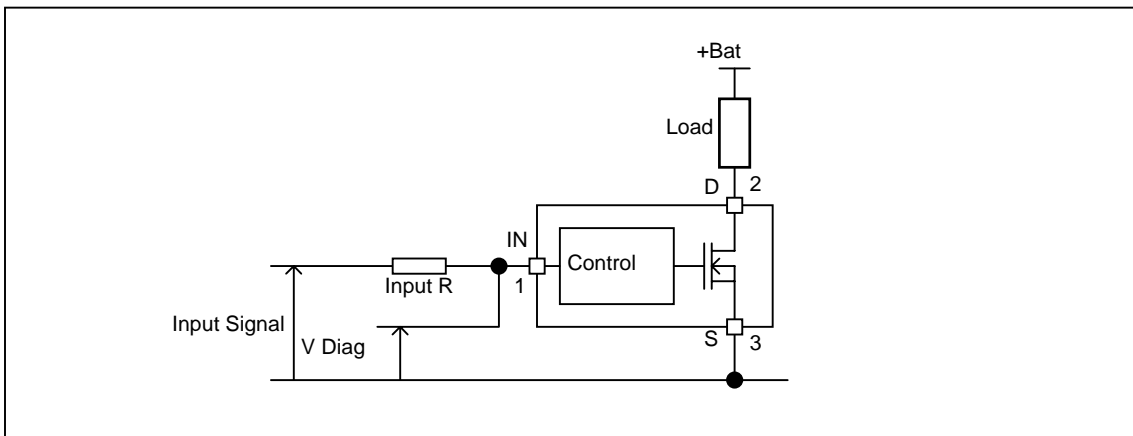
### Product Summary

Rds(on)	300mΩ (max.)
Vclamp	70V
Ishutdown	1.8A (typ.)

### Packages



### Typical Connection



## Qualification Information†

<b>Qualification Level</b>	Automotive (per AEC-Q100 <sup>††</sup> )	
	Comments: This IC has passed an Automotive qualification. IR's Industrial and Consumer qualification level is granted by extension of the higher Automotive level.	
<b>Moisture Sensitivity Level</b>	SOT-223	MSL2 <sup>†††</sup> , 260°C (per IPC/JEDEC J-STD-020)
	8L-SOICN	MSL2 <sup>†††</sup> , 260°C (per IPC/JEDEC J-STD-020)
<b>ESD</b>	Machine Model	Class M3 (per AEC-Q-100-003)
	Human Body Model	Class H2 (per AEC-Q-100-002)
	Charged Device Model	Class C5 (per AEC-Q-100-011)
<b>IC Latch-Up Test</b>	ClassII, Level A (per AEC-Q100-004)	
<b>RoHS Compliant</b>	Yes	

† Qualification standards can be found at International Rectifier's web site <http://www.irf.com/>

†† Exceptions to AEC-Q100 requirements are noted in the qualification report.

††† Higher MSL ratings may be available for the specific package types listed here. Please contact your International Rectifier sales representative for further information.

## Absolute Maximum Ratings

Absolute maximum ratings indicate sustained limits beyond which damage to the device may occur. All voltage parameters are referenced to Ground lead. (Tambient=25°C unless otherwise specified).

Symbol	Parameter	Min.	Max.	Units
Vds	Maximum drain to source voltage	-0.3	60	V
Vds cont.	Maximum continuous drain to source voltage	-	35	V
Vin	Maximum input voltage	-0.3	6	V
Isd cont.	Max diode continuous current (limited by thermal dissipation) Rth=125°C/W	—	1	A
Pd	Maximum power dissipation (internally limited by thermal protection)			W
	Rth=60°C/W AUIPS2051L 1" sqr. footprint	—	2	
	Rth=100°C/W AUIPS2052G std. footprint	—	1.25	
ESD	Electrostatic discharge voltage (Human body) C=100pF, R=1500Ω	—	4	kV
	Between drain and source	—	3	
	Other combinations	—	3	
	Electrostatic discharge voltage (Machine Model) C=200pF, R=0Ω	—	0.5	
	Between drain and source	—	0.3	
	Other combinations	—	0.3	
	Tj max.	Max. storage & operating temperature junction temperature	-40	150

## Thermal Characteristics

Symbol	Parameter	Typ.	Max.	Units
Rth1	Thermal resistance junction to ambient SOT-223 std. footprint	100	—	°C/W
Rth2	Thermal resistance junction to ambient SOT-223 1" sqr. footprint	60	—	
Rth1	Thermal resistance junction to ambient SO-8 std. Footprint	100	—	
	1 die active			
Rth1	Thermal resistance junction to ambient SO-8 std. footprint	130	—	
	2 die active			

note : Tj=Power dissipated in one channel x Rth

## Recommended Operating Conditions

These values are given for a quick design. For operation outside these conditions, please consult the application notes.

Symbol	Parameter	Min.	Max.	Units
VIH	High level input voltage	4	5.5	
VIL	Low level input voltage	0	0.5	
Ids	Continuous drain current, Tambient=85°C, Tj=125°C, Vin=5V, Rth=100°C/W	—	0.9	A
Rin	Recommended resistor in series with IN pin to generate a diagnostic	0.5	5	kΩ
Max. t rise	Max. input rising time	—	1	µs

### Static Electrical Characteristics

T<sub>J</sub>=-40..150°C, V<sub>CC</sub>=28V (unless otherwise specified)

Symbol	Parameter	Min.	Typ.	Max.	Units	Test Conditions
R <sub>ds(on)</sub>	ON state resistance T <sub>J</sub> =25°C	—	250	300	mΩ	V <sub>in</sub> =5V, I <sub>ds</sub> =1A
	ON state resistance T <sub>J</sub> =150°C(2)	—	440	520		
I <sub>dss1</sub>	Drain to source leakage current	—	0.2	1	μA	V <sub>CC</sub> =28V, T <sub>J</sub> =25°C
I <sub>dss2</sub>	Drain to source leakage current	—	0.5	2		V <sub>CC</sub> =50V, T <sub>J</sub> =25°C
V <sub>clamp1</sub>	Drain to source clamp voltage 1	63	69	—	V	Id=20mA See fig. 3 & 4
V <sub>clamp2</sub>	Drain to source clamp voltage 2	—	70	75		Id=150mA
V <sub>in clamp</sub>	IN to source pin clamp voltage	5.5	6.2	7.5		I <sub>in</sub> =1mA
V <sub>th</sub>	Input threshold voltage	1.1	2	2.7		Id=50mA
I <sub>in, on</sub>	ON state IN positive current	15	40	80	μA	V <sub>in</sub> =5V
I <sub>in, off</sub>	OFF state IN positive current ( after protection latched )	150	250	350		

### Switching Electrical Characteristics

V<sub>CC</sub>=28V, Resistive load=50Ω, R<sub>input</sub>=50Ω, V<sub>in</sub>=5V, T<sub>J</sub>=25°C

Symbol	Parameter	Min.	Typ.	Max.	Units	Test Conditions
T <sub>d(on)</sub>	Turn-on delay time to 20%	0.1	1	3	μs	See figure 2
T <sub>r</sub>	Rise time 20% to 80%	0.1	0.3	2.5		
T <sub>d(off)</sub>	Turn-off delay time to 80%	1	1.8	3.5		
T <sub>f</sub>	Fall time 80% to 20%	0.1	0.5	2.5		
E <sub>on</sub> + E <sub>off</sub>	Turn on and off energy	—	5	—	μJ	

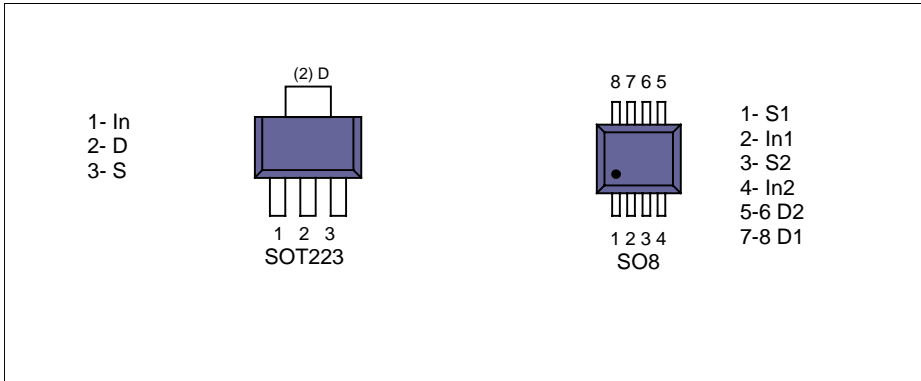
### Protection Characteristics

T<sub>J</sub>=-40..150°C, V<sub>CC</sub>=28V (unless otherwise specified)

Symbol	Parameter	Min.	Typ.	Max.	Units	Test Conditions
T <sub>sd</sub>	Over temperature threshold	150(2)	165	—	°C	See figure 1
I <sub>sd</sub>	Over current threshold	1.2	1.8	3	A	See figure 1
V <sub>reset</sub>	IN protection reset threshold	1.1	1.6	2	V	
T <sub>reset</sub>	Time to reset protection	15(2)	50	500	μs	V <sub>in</sub> =0V, T <sub>J</sub> =25°C

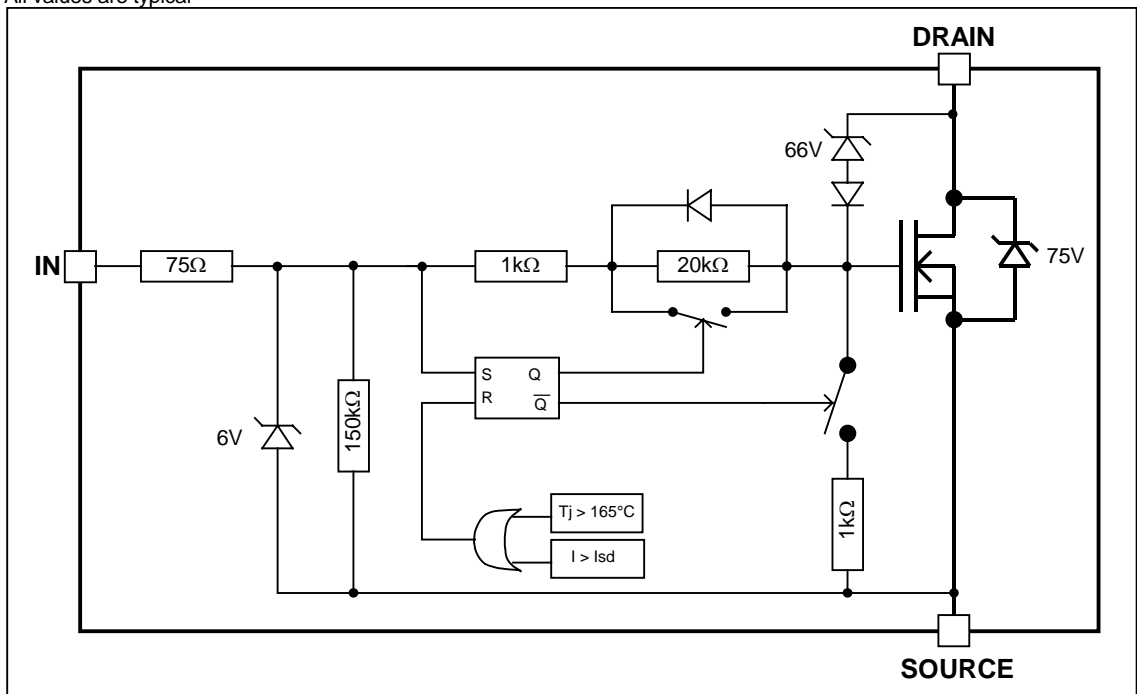
(2) Guaranteed by design

## Lead Assignments

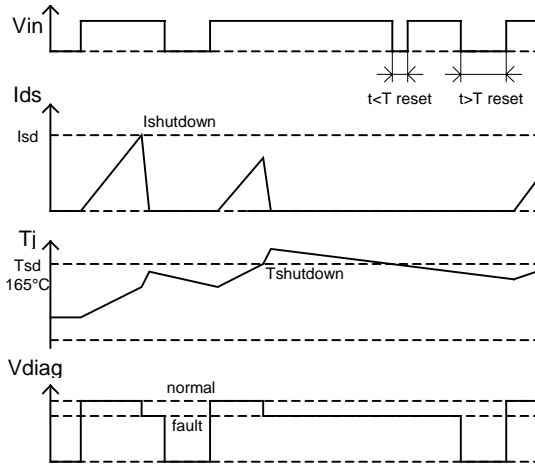


## Functional Block Diagram

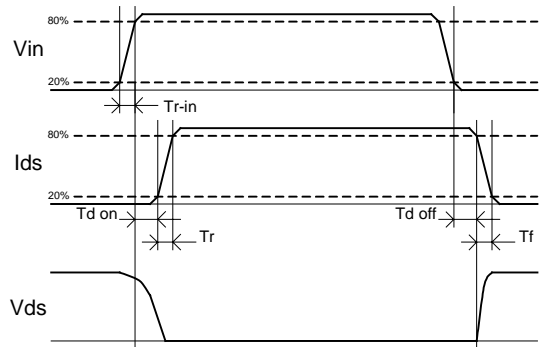
All values are typical



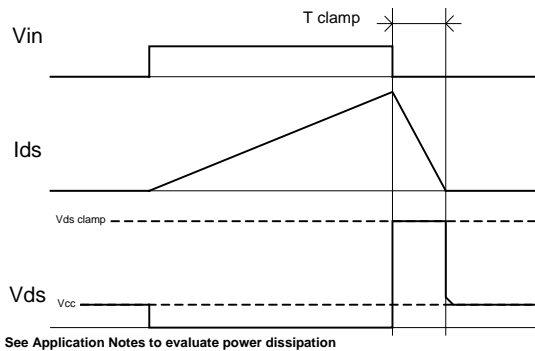
All curves are typical values. Operating in the shaded area is not recommended.



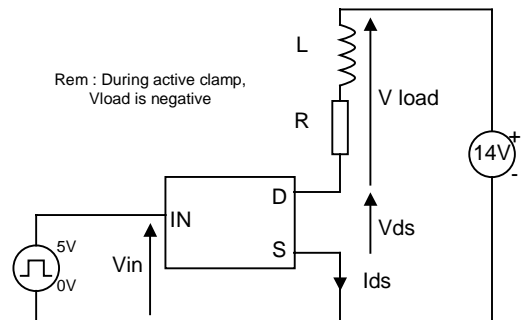
**Figure 1 – Timing diagram**



**Figure 2 – IN rise time & switching definitions**



**Figure 3 – Active clamp waveforms**



**Figure 4 – Active clamp test circuit**

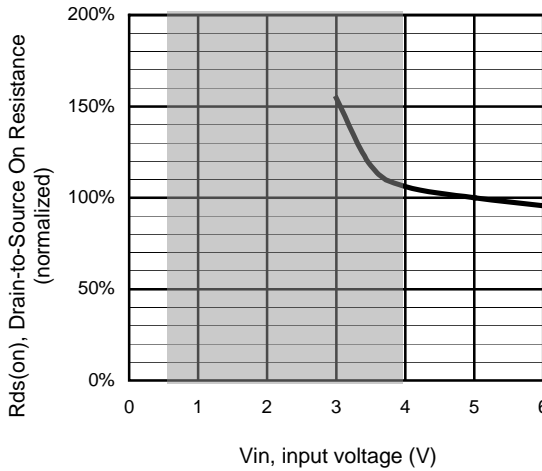


Figure 5 – Normalized Rds(on) (%) Vs Input voltage (V)

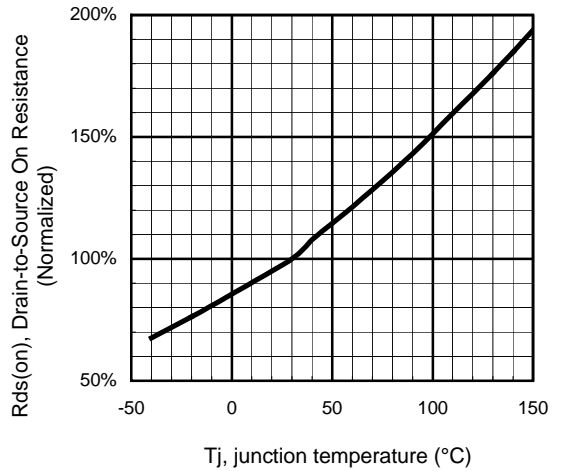


Figure 6 - Normalized Rds(on) (%) Vs Tj (°C)

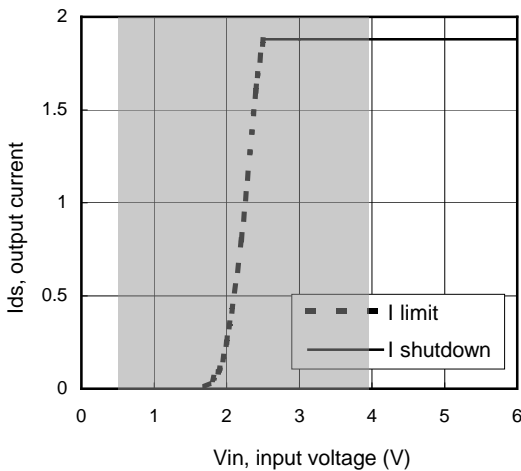


Figure 7 – Current limitation and current shutdown Vs Input voltage (V)

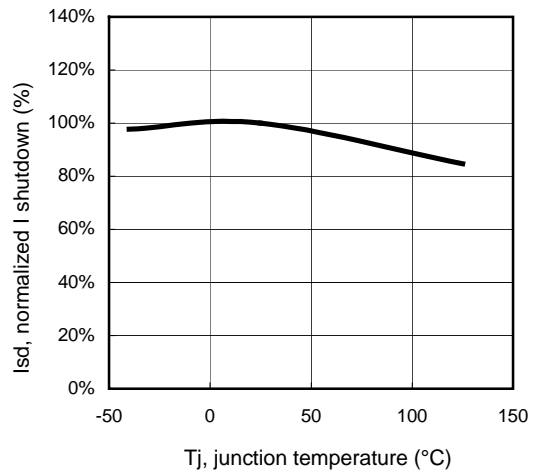
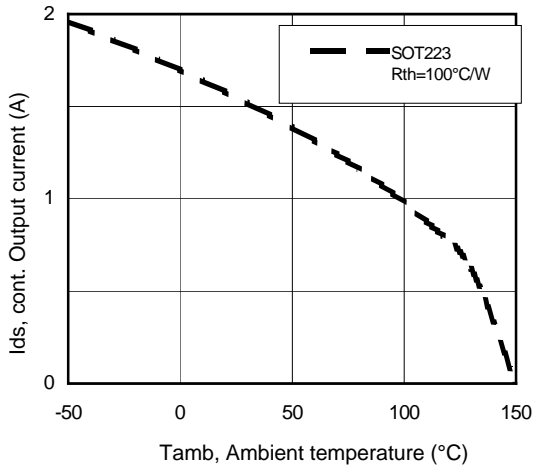
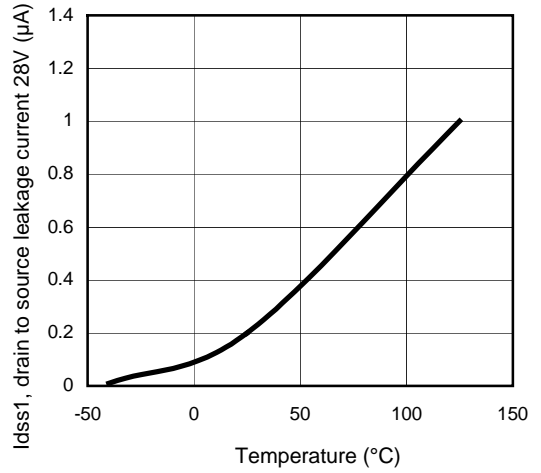


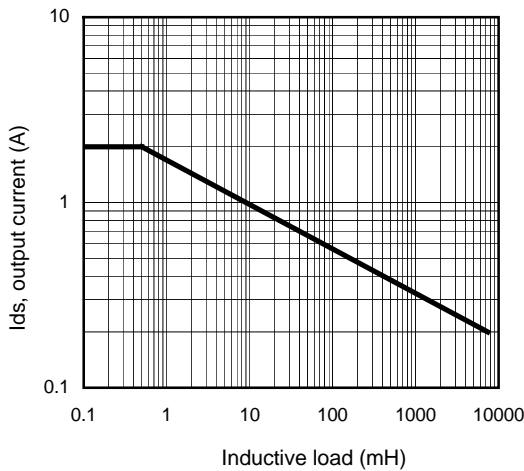
Figure 8 – Normalized I shutdown (%) Vs junction temperature (°C)



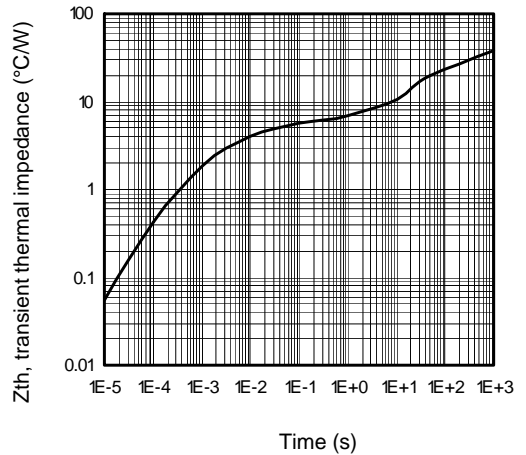
**Figure 9 – Max. continuous output current (A) Vs Ambient temperature (°C)**



**Figure 10 – Idss1 (µA) Vs temperature (°C)**

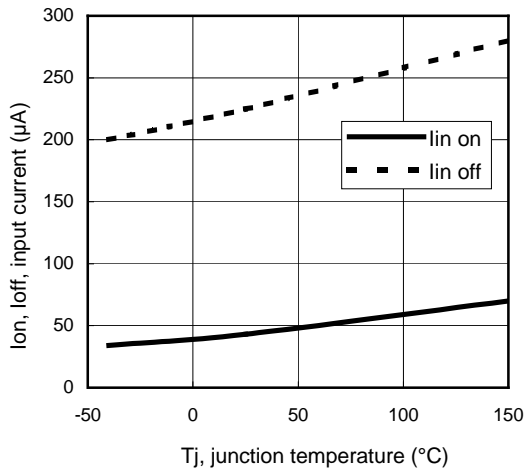


**Figure 11 – Max. output current (A) Vs Inductive load (mH)**

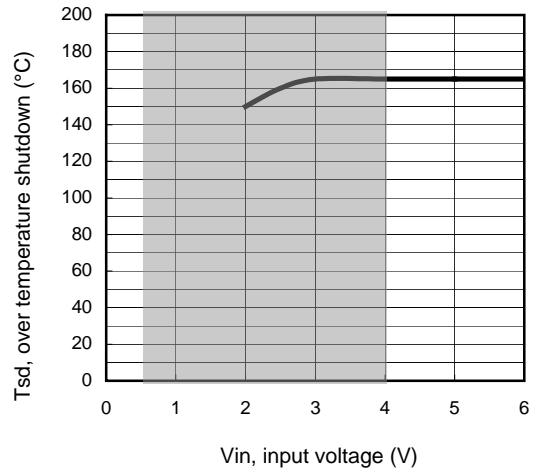


**Figure 12 – Transient thermal impedance (°C/W) Vs time (s)**



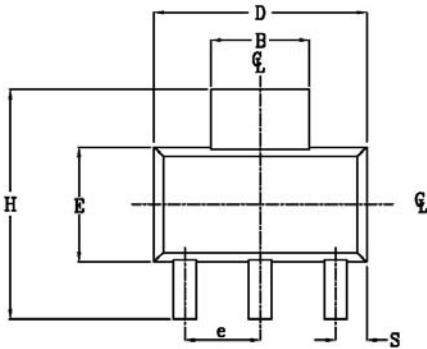


**Figure 13 – Input current (µA) On and Off Vs junction temperature (°C)**



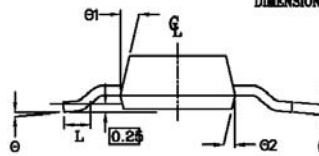
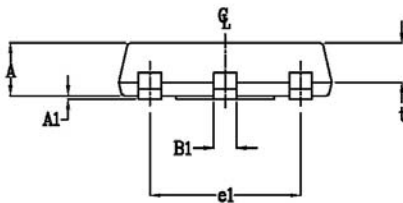
**Figure 14 – Over temperature shutdown (°C) Vs input voltage (V)**

## Case Outline - SOT-223 - Automotive Q100 PbF MSL2 qualified



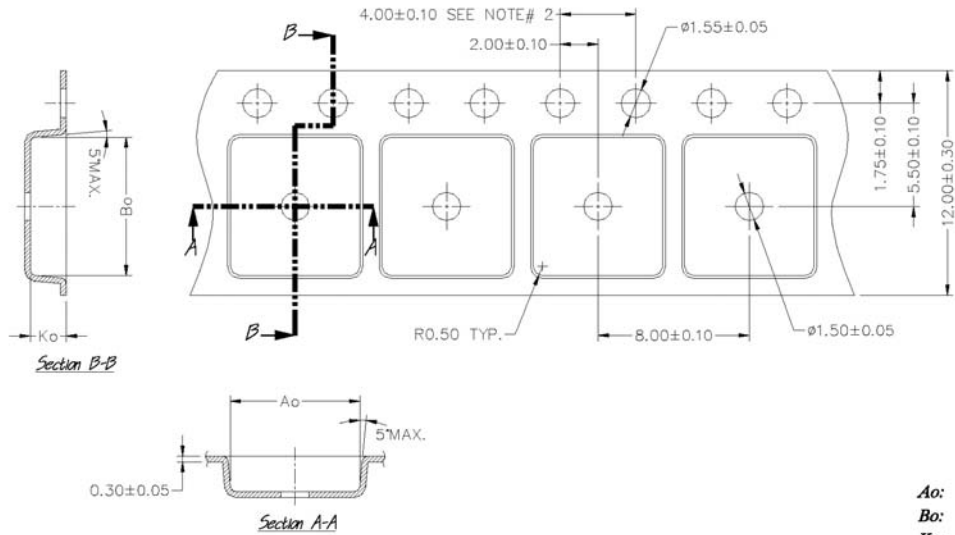
POS	MILLIMETERS		INCHES	
	MAX	MIN	MAX	MIN
I				
A	1.70	1.50	.067	.060
A1	0.10	0.02	.004	.0008
B	3.15	2.95	.124	.116
B1	0.85	0.65	.033	.026
C	0.35	0.25	.014	.010
D	6.70	6.30	.264	.248
e	2.30 NOM		.0905 NOM	
e1	4.60 NOM		.181 NOM	
E	3.70	3.30	.146	.130
H	7.30	6.70	.287	.264
S	1.05	0.85	.041	.033
t	1.30	1.10	.051	.043
⊙	10° MAX		10° MAX	
⊙1	16°	10°	16°	10°
⊙2	16°	10°	16°	10°
L	0.75 MIN		0.0295 MIN	

NOTE:  
 1. PACKAGE OUTLINE EXCLUSIVE OF ANY MOLD FLASHES DIMENSION.  
 2. PACKAGE OUTLINE EXCLUSIVE OF BURR DIMENSION.



Leads and drain are plated with 100% Sn

## Tape & Reel - SOT-223



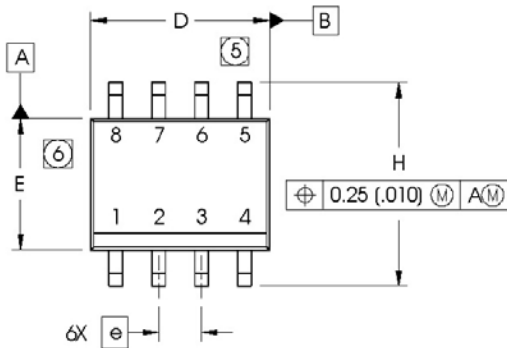
<b>Ao:</b>	<b>6.85</b>
<b>Bo:</b>	<b>7.40</b>
<b>Ko:</b>	<b>1.90</b>
<b>Pitch:</b>	<b>8.00</b>
<b>Width:</b>	<b>12.00</b>

**NOTES:**

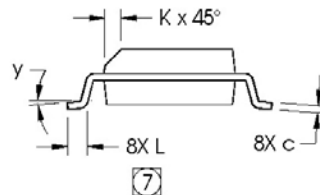
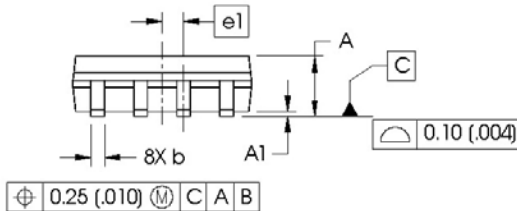
1. Ao & Bo are measured at 0.3mm above base of pocket.
2. 10 pitches cumulative tol. ±0.2mm.

## Case Outline - SO-8 - Automotive Q100 PbF MSL2 qualified

Dimensions are shown in millimeters (inches)

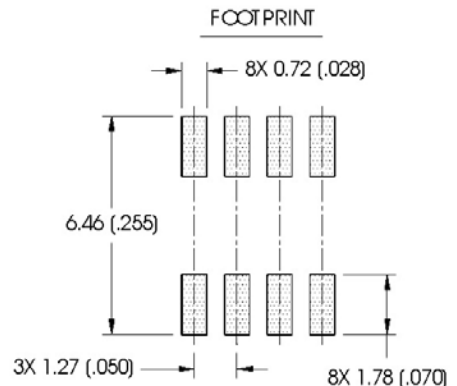


DIM	INCHES		MILLIMETERS	
	MIN	MAX	MIN	MAX
A	.0532	.0688	1.35	1.75
A1	.0040	.0098	0.10	0.25
b	.013	.020	0.33	0.51
c	.0075	.0098	0.19	0.25
D	.189	.1968	4.80	5.00
E	.1497	.1574	3.80	4.00
e	.050 BASIC		1.27 BASIC	
e1	.025 BASIC		0.635 BASIC	
H	.2284	.2440	5.80	6.20
K	.0099	.0196	0.25	0.50
L	.016	.050	0.40	1.27
y	0°	8°	0°	8°



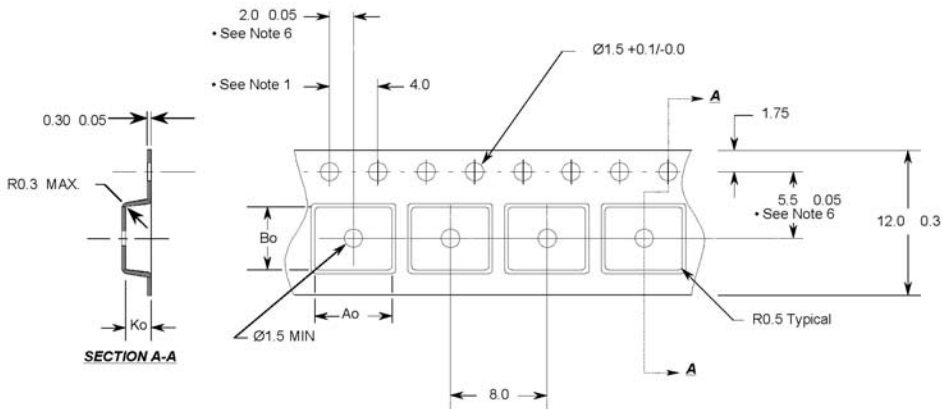
**NOTES:**

1. DIMENSIONING & TOLERANCING PER ASME Y14.5M-1994.
2. CONTROLLING DIMENSION: MILLIMETER
3. DIMENSIONS ARE SHOWN IN MILLIMETERS (INCHES).
4. OUTLINE CONFORMS TO JEDEC OUTLINE MS-012AA.
5. DIMENSION DOES NOT INCLUDE MOLD PROTRUSIONS. MOLD PROTRUSIONS NOT TO EXCEED 0.15 (.006).
6. DIMENSION DOES NOT INCLUDE MOLD PROTRUSIONS. MOLD PROTRUSIONS NOT TO EXCEED 0.25 (.010).
7. DIMENSION IS THE LENGTH OF LEAD FOR SOLDERING TO A SUBSTRATE.



Leads and drain are plated with 100% Sn

## Tape & Reel - SO-8



**Notes:**

1. 10 sprocket hole pitch cumulative tolerance 0.2
2. Camber not to exceed 1mm in 100mm
3. Material: Black Conductive Advantek Polystyrene
4. Ao and Bo measured on a plane 0.3mm above the bottom of the pocket
5. Ko measured from a plane on the inside bottom of the pocket to the top surface of the carrier.
6. Pocket position relative to sprocket hole measured as true position of pocket, not pocket hole.

Ao = 6.4 mm  
 Bo = 5.2 mm  
 Ko = 2.1 mm

- All Dimensions in Millimeters -

The information provided in this document is believed to be accurate and reliable. However, International Rectifier assumes no responsibility for the consequences of the use of this information. International Rectifier assumes no responsibility for any infringement of patents or of other rights of third parties which may result from the use of this information. No license is granted by implication or otherwise under any patent or patent rights of International Rectifier. The specifications mentioned in this document are subject to change without notice. This document supersedes and replaces all information previously supplied.

For technical support, please contact IR's Technical Assistance Center  
<http://www.irf.com/technical-info/>

**WORLD HEADQUARTERS:**  
 233 Kansas St., El Segundo, California 90245  
 Tel: (310) 252-7105