

FEATURES

- InGaP HBT Technology
- High Efficiency (35% Typ)
- Low Leakage Current (5 μ A)
- SMT Module Package
- Small Foot Print (6mm x 6mm)
- Low Profile (1.5mm)
- 50 Ω Input and Output Matching
- $P_{OUT} = 28.5$ dBm @ $I_{cq} = 60$ mA Typ
- No Mode Switching Required
- CDMA 2000 1XRTT Compliant

APPLICATIONS

- Korean Band PCS CDMA Handsets

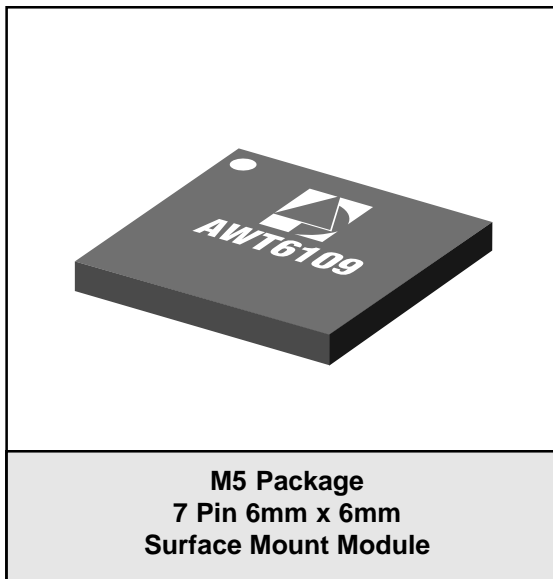

PRODUCT DESCRIPTION

The AWT6109 is a 3.5 V (3.0 V to 4.2 V) high efficiency, 3 stage amplifier module for Korean Band PCS handsets. The device is manufactured on an advanced InGaP HBT MMIC technology offering state-of-the-art reliability, temperature stability, and ruggedness. Full output power is achieved at a low

quiescent current of 60mA, reducing power drain on the system battery. No switching is required between high and low output power levels. The 6mm x 6mm laminate package is self contained, incorporating 50 Ω input and output matching networks optimized for output power, linearity, and efficiency.

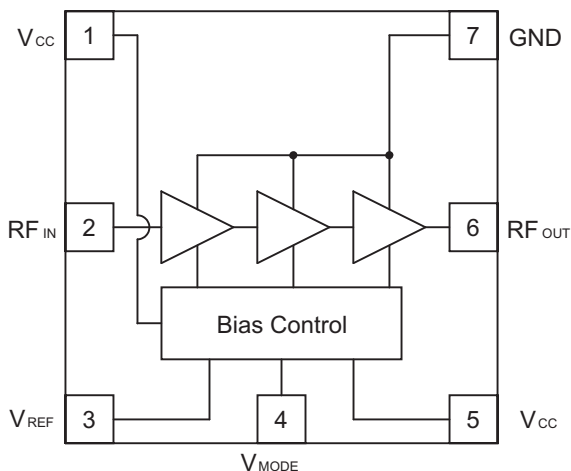

Figure 1: Block Diagram

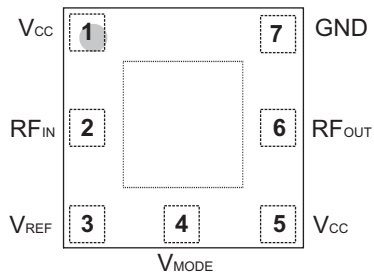

Figure 2: Pinout (X-ray Top View)

Table 1: Pin Description

PIN	NAME	DESCRIPTION
1	V _{CC}	Supply Voltage
2	RF _{IN}	RF Input Signal
3	V _{REF}	Reference Voltage
4	V _{MODE}	Mode Control
5	V _{CC}	Supply Voltage
6	RF _{OUT}	RF Output
7	GND	Ground

ELECTRICAL CHARACTERISTICS

Table 2: Absolute Minimum and Maximum Ratings

PARAMETER	MIN	MAX	UNIT
Supply Voltage (V_{CC})	0	+5	V
Mode Control Voltage (V_{MODE})	0	+3.5	V
Reference Voltage (V_{REF})	0	+3.5	V
RF Input Power (P_{IN})	-	+10	dBm
Storage Temperature (T_{STG})	-40	+150	°C

Stresses in excess of the absolute ratings may cause permanent damage. Functional operation is not implied under these conditions. Exposure to absolute ratings for extended periods of time may adversely affect reliability.

Table 3: Operating Ranges

PARAMETER	MIN	TYP	MAX	UNIT	COMMENTS
Operating Frequency (f)	1750	-	1780	MHz	
Supply Voltage (V_{CC})	+3.0	+3.5	+4.2	V	
Reference Voltage (V_{REF})	+2.75 0	+3.0 -	+3.1 +0.5	V	PA "on" PA "shut down"
Mode Control Voltage (V_{MODE})	+2.5 0	+2.7 -	+3.1 +0.5	V	PA "on" PA "shut down"
RF Output Power (P_{OUT})	+28	+28.5	-	dBm	
Case Temperature (T_C)	-30	-	+110	°C	

The device may be operated safely over these conditions; however, parametric performance is guaranteed only over the conditions defined in the electrical specifications.

Table 4: Electrical Specifications**(T_C = +25 °C, V_{CC} = +3.5 V, V_{REF} = +3.0 V, V_{MODE} = +2.7 V, P_{OUT} = +28.5 dBm, 50Ω System)**

PARAMETER	MIN	TYP	MAX	UNIT	COMMENTS
Gain	27	30.5	32	dB	
Adjacent Channel Power at ±1.25 MHz offset	-	-52.5	-46.5	dB	Primary Channel BW = 1.23 MHz Adjacent Channel BW = 30KHz
Adjacent Channel Power at ±2.25 MHz offset	-	-60	-57	dB	Primary Channel BW = 1.23 MHz Adjacent Channel BW = 30KHz
Efficiency	31 6	35 7	- -	%	+28.5 dBm Output Power +16 dBm Output Power
Quiescent Current (I _q)	50	65	85	mA	
Leakage Current (shutdown mode)		<5	10	μA	V _{REF} = 0 V, V _{MODE} = 0 V
Noise in Receive Band	-	-136	-134	dBm/Hz	1840 MHz to 1870 MHz
Harmonics 2fo 3fo, 4fo	- -	-42 -50	-30 -30	dBc	
Input Impedance	-	-	2:1	VSWR	
Spurious Output Level (all spurious outputs)	-	-	-70	dBc	P _{OUT} ≤ +29 dBm In-band load VSWR < 8:1 Out-of-band load VSWR < 8:1 Applies over all voltage and temperature operating ranges
Load mismatch stress with no permanent degradation or failure	8:1	-	-	VSWR	V _{CC} = +5.0 V P _{IN} = +5 dBm Applies over full operating temperature range

PERFORMANCE DATA

Figure 3: Gain and Efficiency vs. P_{OUT}
 (f = 1750 MHz, V_{CC} = +3.0 V, V_{REF} = +3.0 V,
 V_{MODE} = +2.7 V)

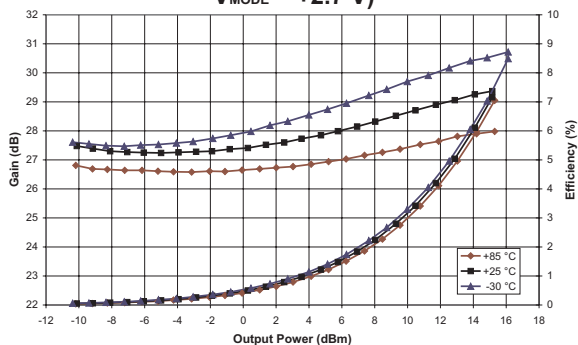

Figure 4: Adjacent Channel Power vs. P_{OUT}
 (f = 1780 MHz, V_{CC} = +3.0 V, V_{REF} = +3.0 V,
 V_{MODE} = +2.7 V, Δf_{ACP} = 1.25 MHz)

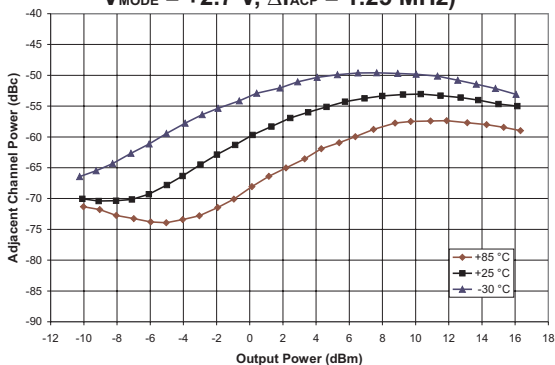

Figure 5: Gain and Efficiency vs. P_{OUT}
 (f = 1750 MHz, V_{CC} = +3.5 V, V_{REF} = +3.0 V,
 V_{MODE} = +2.7 V)

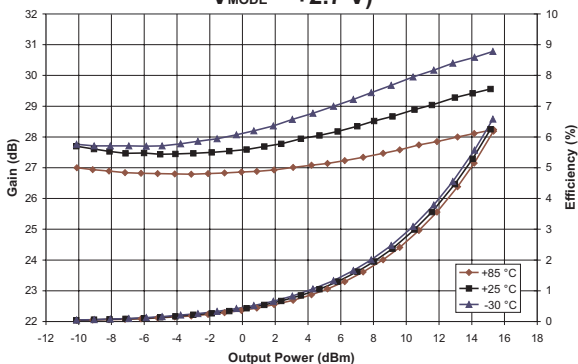

Figure 6: Adjacent Channel Power vs. P_{OUT}
 (f = 1780 MHz, V_{CC} = +3.5 V, V_{REF} = +3.0 V,
 V_{MODE} = +2.7 V, Δf_{ACP} = 1.25 MHz)

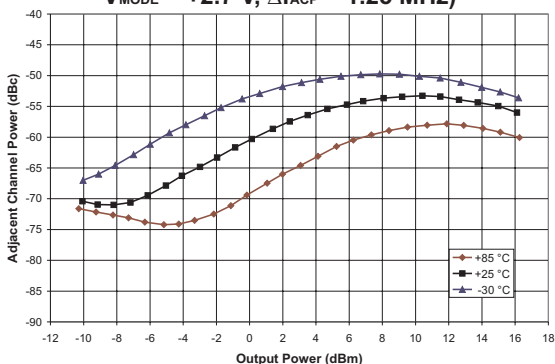

Figure 7: Gain and Efficiency vs. P_{OUT}
 (f = 1750 MHz, V_{CC} = +4.2 V, V_{REF} = +3.0 V,
 V_{MODE} = +2.7 V)

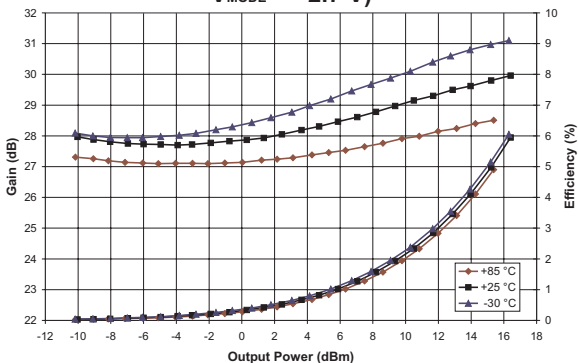

Figure 8: Adjacent Channel Power vs. P_{OUT}
 (f = 1780 MHz, V_{CC} = +4.2 V, V_{REF} = +3.0 V,
 V_{MODE} = +2.7 V, Δf_{ACP} = 1.25 MHz)

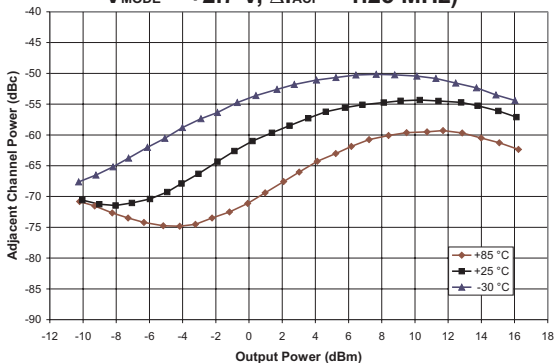

Figure 9: Adjacent Channel Power vs. Freq.
 ($P_{OUT} = +28.5$ dBm, $V_{CC} = +3.5$ V, $V_{REF} = +3.0$ V,
 $V_{MODE} = +2.7$ V, $\Delta f_{ACP} = 1.25$ MHz)

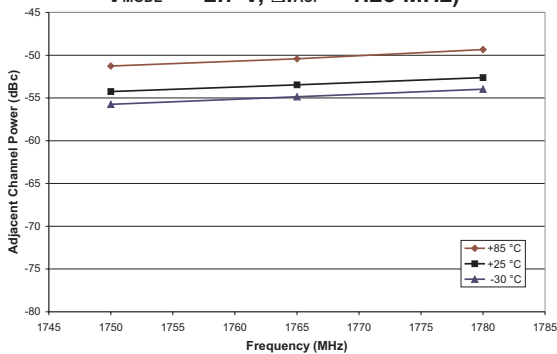

Figure 10: Adjacent Channel Power vs. Freq.
 ($P_{OUT} = +16.0$ dBm, $V_{CC} = +3.5$ V, $V_{REF} = +3.0$ V,
 $V_{MODE} = +2.7$ V, $\Delta f_{ACP} = 1.25$ MHz)

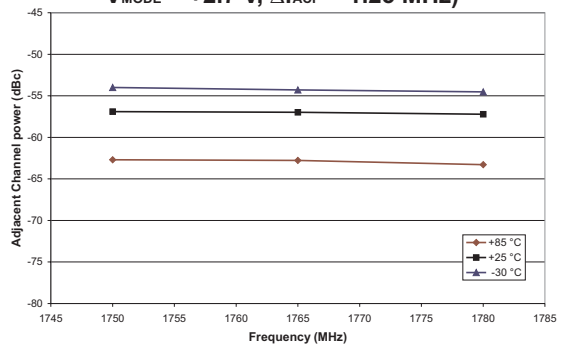

Figure 11: Adjacent Channel Power vs. Freq.
 ($P_{OUT} = +28.5$ dBm, $V_{CC} = +3.5$ V, $V_{REF} = +3.0$ V,
 $V_{MODE} = +2.7$ V, $\Delta f_{ACP} = 2.25$ MHz)

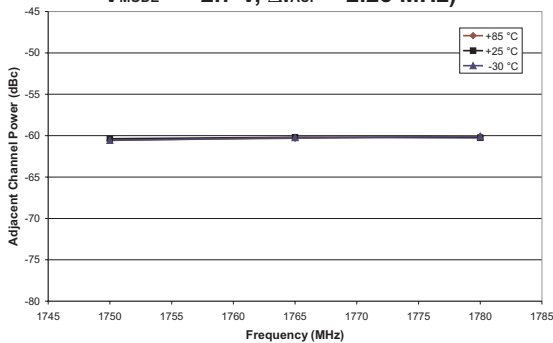

Figure 12: Adjacent Channel Power vs. Freq.
 ($P_{OUT} = +16.0$ dBm, $V_{CC} = +3.5$ V, $V_{REF} = +3.0$ V,
 $V_{MODE} = +2.7$ V, $\Delta f_{ACP} = 2.25$ MHz)

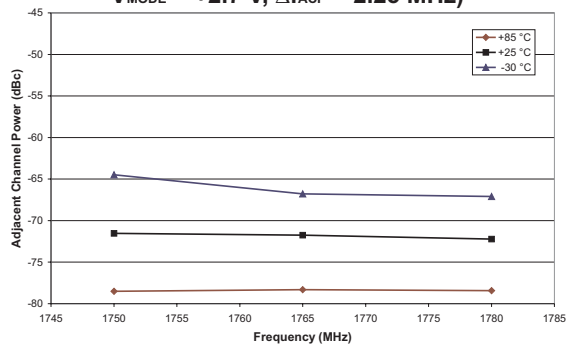

Figure 13: Power-Added Efficiency vs. Freq.
 ($P_{OUT} = +28.5$ dBm, $V_{CC} = +3.5$ V,
 $V_{REF} = +3.0$ V, $V_{MODE} = +2.7$ V)

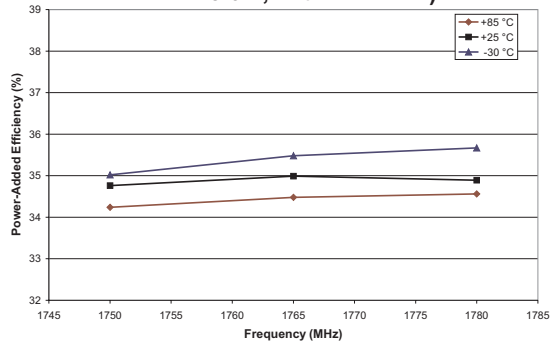

Figure 14: Power-Added Efficiency vs. Freq.
 ($P_{OUT} = +16.0$ dBm, $V_{CC} = +3.5$ V,
 $V_{REF} = +3.0$ V, $V_{MODE} = +2.7$ V)

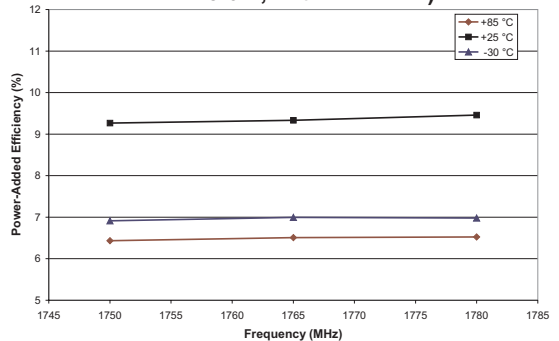

Figure 15: Large Signal Gain vs. Freq.
 ($P_{OUT} = +28.5 \text{ dBm}$, $V_{CC} = +3.5 \text{ V}$,
 $V_{REF} = +3.0 \text{ V}$, $V_{MODE} = +2.7 \text{ V}$)

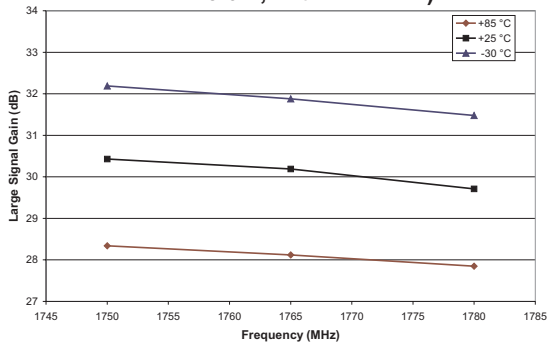

Figure 16: Large Signal Gain vs. Freq.
 ($P_{OUT} = +16.0 \text{ dBm}$, $V_{CC} = +3.5 \text{ V}$,
 $V_{REF} = +3.0 \text{ V}$, $V_{MODE} = +2.7 \text{ V}$)

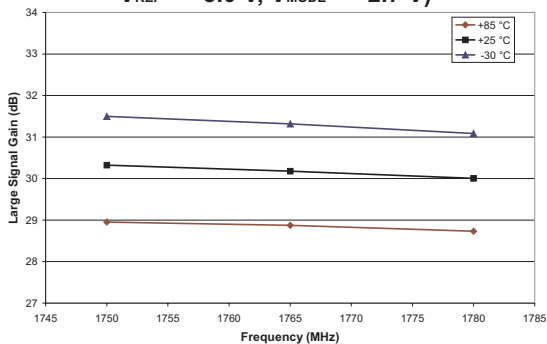

Figure 17: Small Signal Gain vs. Freq.
 ($P_{IN} = -20 \text{ dBm}$, $V_{CC} = +3.5 \text{ V}$,
 $V_{REF} = +3.0 \text{ V}$, $V_{MODE} = +2.7 \text{ V}$)

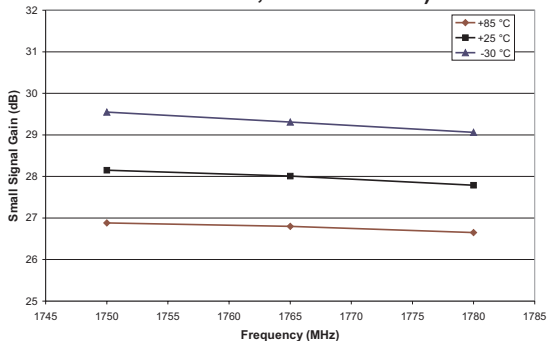

Figure 18: Gain and Efficiency vs. P_{OUT}
 (f = 1765 MHz, V_{CC} = +3.5 V,
 V_{REF} = +2.85 V, V_{MODE} = +2.7 V)

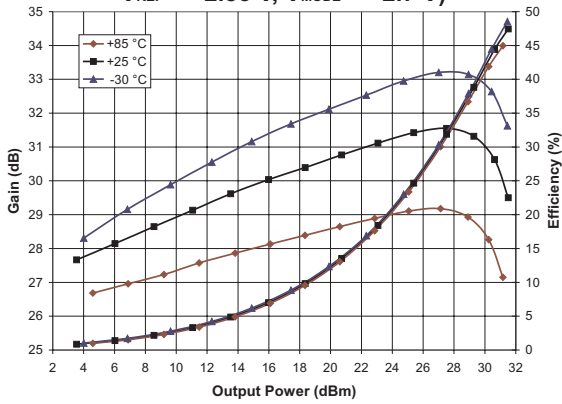

Figure 19: Output Power vs. Input Power
 (f = 1765 MHz, V_{CC} = +3.5 V,
 V_{REF} = +2.85 V, V_{MODE} = +2.7 V)

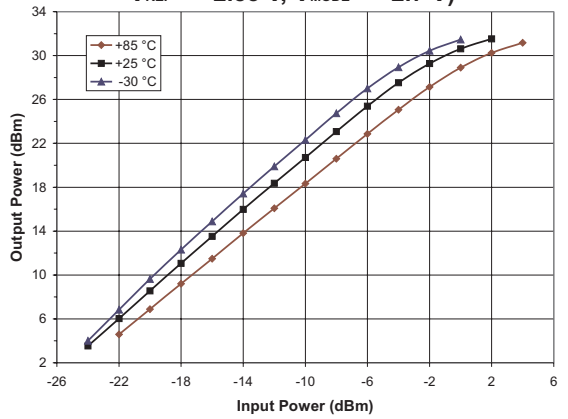

Figure 20: Gain vs. Frequency
 (P_{OUT} = +28.5 dBm, V_{CC} = +3.5 V,
 V_{REF} = +2.85 V, V_{MODE} = +2.7 V)

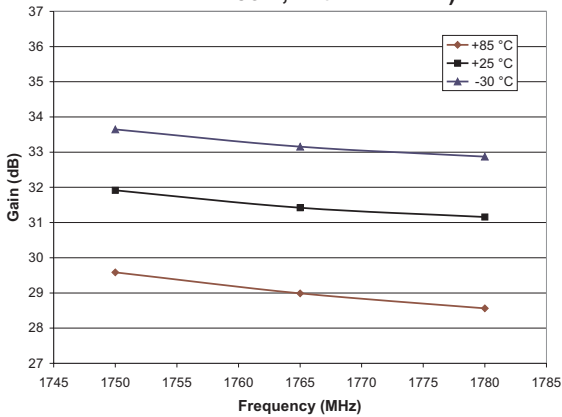

Figure 21: Power-Added Efficiency vs. Freq.
 (P_{OUT} = +28.5 dBm, V_{CC} = +3.5 V,
 V_{REF} = +2.85 V, V_{MODE} = +2.7 V)

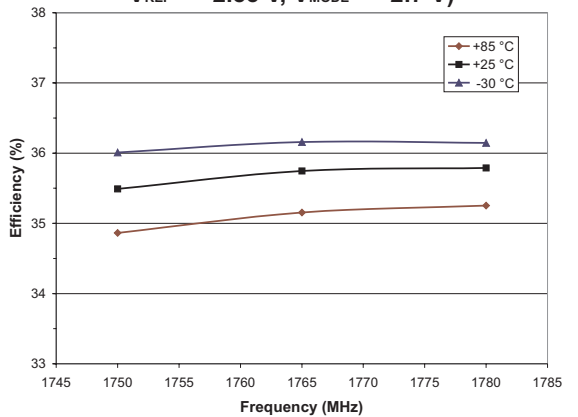

Figure 22: Gain vs. Frequency
 (P_{OUT} = +16.0 dBm, V_{CC} = +3.5 V,
 V_{REF} = +2.85 V, V_{MODE} = +2.7 V)

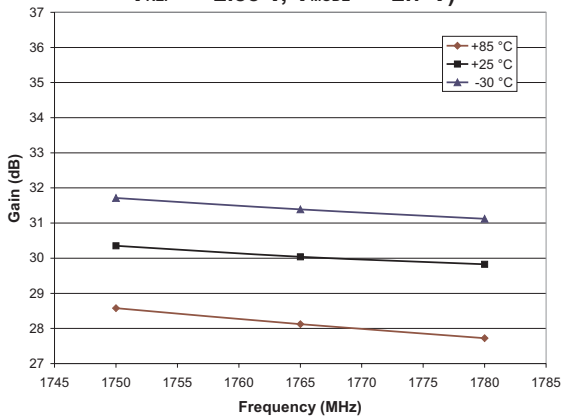

Figure 23: Power-Added Efficiency vs. Freq.
 (P_{OUT} = +16.0 dBm, V_{CC} = +3.5 V,
 V_{REF} = +2.85 V, V_{MODE} = +2.7 V)

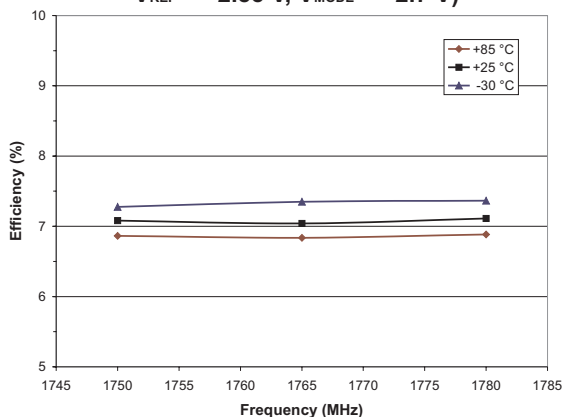

Figure 24: Adjacent Channel Power vs. P_{OUT}
 (f = 1765 MHz, V_{CC} = +3.5 V, V_{REF} = +2.85 V,
 V_{MODE} = +2.7 V, Δf_{ACP} = 1.25 MHz)

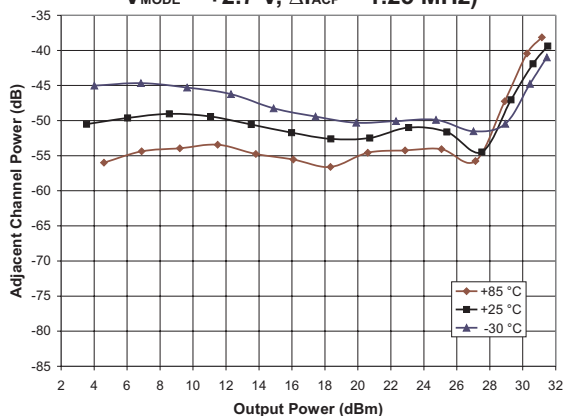

Figure 25: Adjacent Channel Power vs. P_{OUT}
 (f = 1765 MHz, V_{CC} = +3.5 V, V_{REF} = +2.85 V,
 V_{MODE} = +2.7 V, Δf_{ACP} = 2.25 MHz)

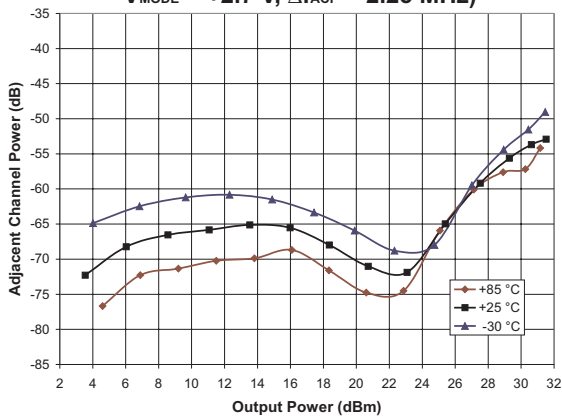

Figure 26: Adjacent Channel Power vs. Freq.
 (P_{OUT} = 28.5 dBm, V_{CC} = +3.5 V, V_{REF} = +2.85 V,
 V_{MODE} = +2.7 V, Δf_{ACP} = 1.25 MHz)

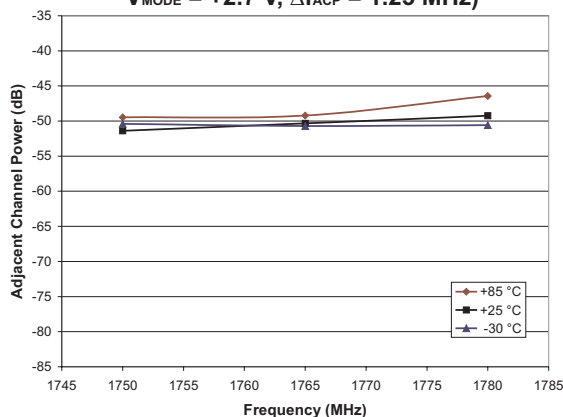

Figure 27: Adjacent Channel Power vs. Freq.
 (P_{OUT} = +28.5 dBm, V_{CC} = +3.5 V, V_{REF} = +2.85 V,
 V_{MODE} = +2.7 V, Δf_{ACP} = 2.25 MHz)

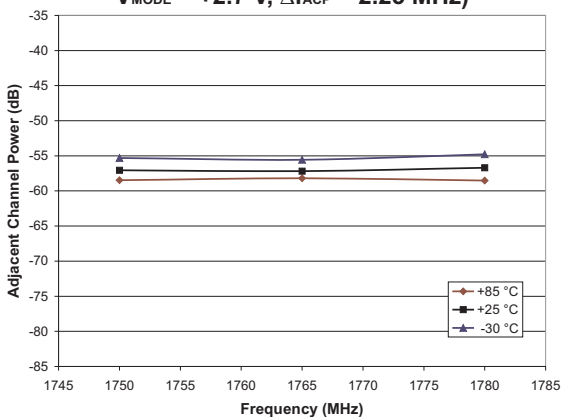

Figure 28: Adjacent Channel Power vs. Freq.
 (P_{OUT} = +16.0 dBm, V_{CC} = +3.5 V, V_{REF} = +2.85 V,
 V_{MODE} = +2.7 V, Δf_{ACP} = 1.25 MHz)

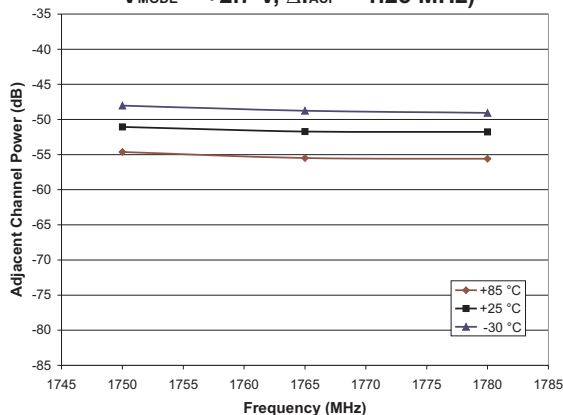

Figure 29: Adjacent Channel Power vs. Freq.
 (P_{OUT} = +16.0 dBm, V_{CC} = +3.5 V, V_{REF} = +2.85 V,
 V_{MODE} = +2.7 V, Δf_{ACP} = 2.25 MHz)

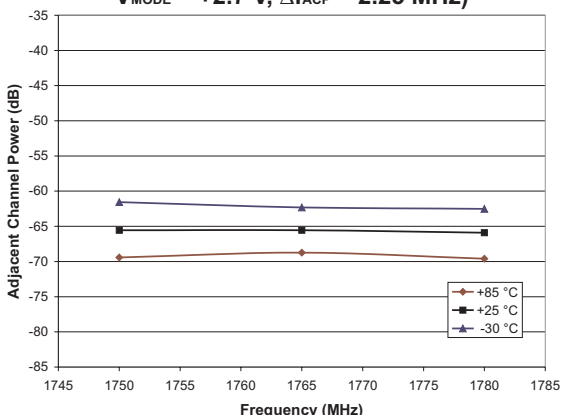

Figure 30: Harmonic Levels vs. P_{OUT}
 (f = 1765 MHz, V_{CC} = +3.5 V,
 V_{REF} = +2.85 V, V_{MODE} = +2.7 V)

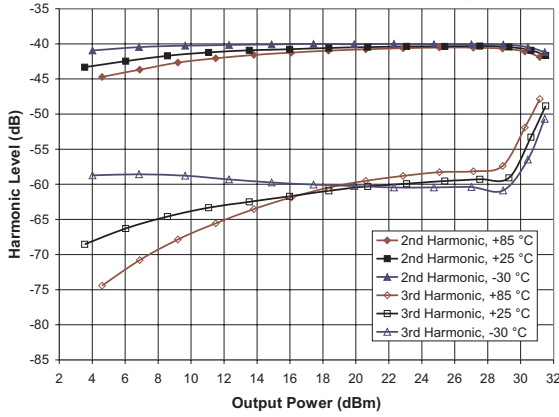

Figure 31: Current Consumption vs. P_{OUT}
 (f = 1765 MHz, V_{CC} = +3.5 V,
 V_{REF} = +2.85 V, V_{MODE} = +2.7 V)

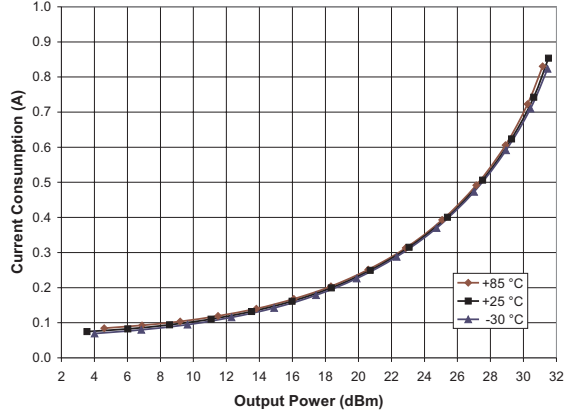

Figure 32: Harmonic Levels vs. Freq.
 (P_{OUT} = +28.5 dBm, V_{CC} = +3.5 V,
 V_{REF} = +2.85 V, V_{MODE} = +2.7 V)

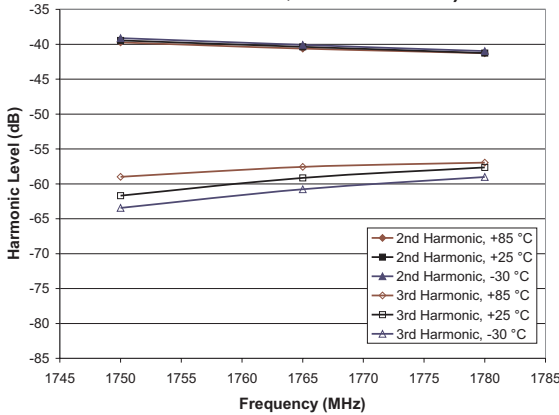

Figure 33: Current Consumption vs. Freq.
 (P_{OUT} = +28.5 dBm, V_{CC} = +3.5 V,
 V_{REF} = +2.85 V, V_{MODE} = +2.7 V)

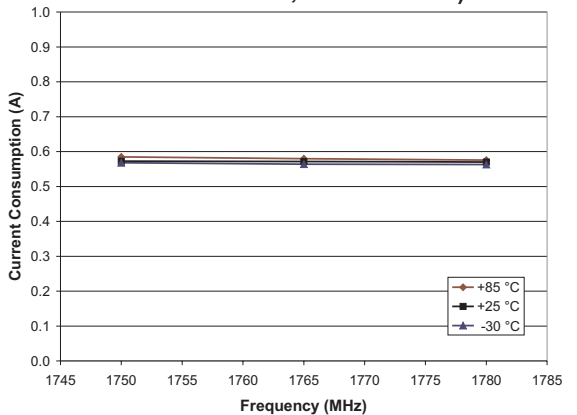

Figure 34: Harmonic Levels vs. Freq.
 (P_{OUT} = +16.0 dBm, V_{CC} = +3.5 V,
 V_{REF} = +2.85 V, V_{MODE} = +2.7 V)

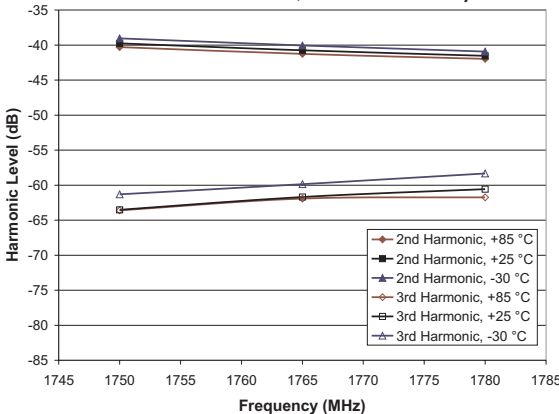
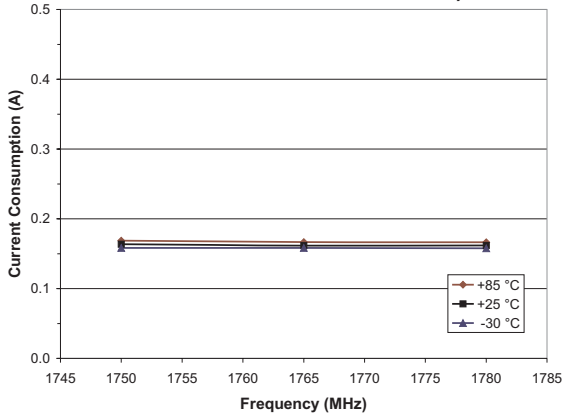

Figure 35: Current Consumption vs. Freq.
 (P_{OUT} = +16.0 dBm, V_{CC} = +3.5 V,
 V_{REF} = +2.85 V, V_{MODE} = +2.7 V)



APPLICATION INFORMATION

To ensure proper performance, refer to all related Application Notes on the ANADIGICS web site: <http://www.anadigics.com>

Shutdown Mode

The power amplifier may be placed in a shutdown mode by applying logic low levels (see Operating Ranges table) to both the V_{REF} and V_{MODE} voltages.

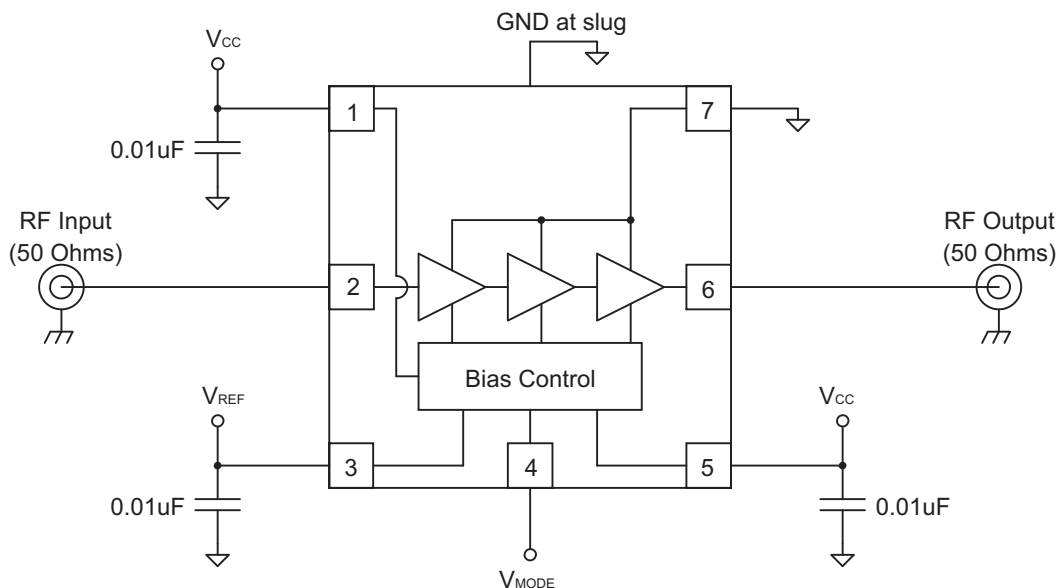
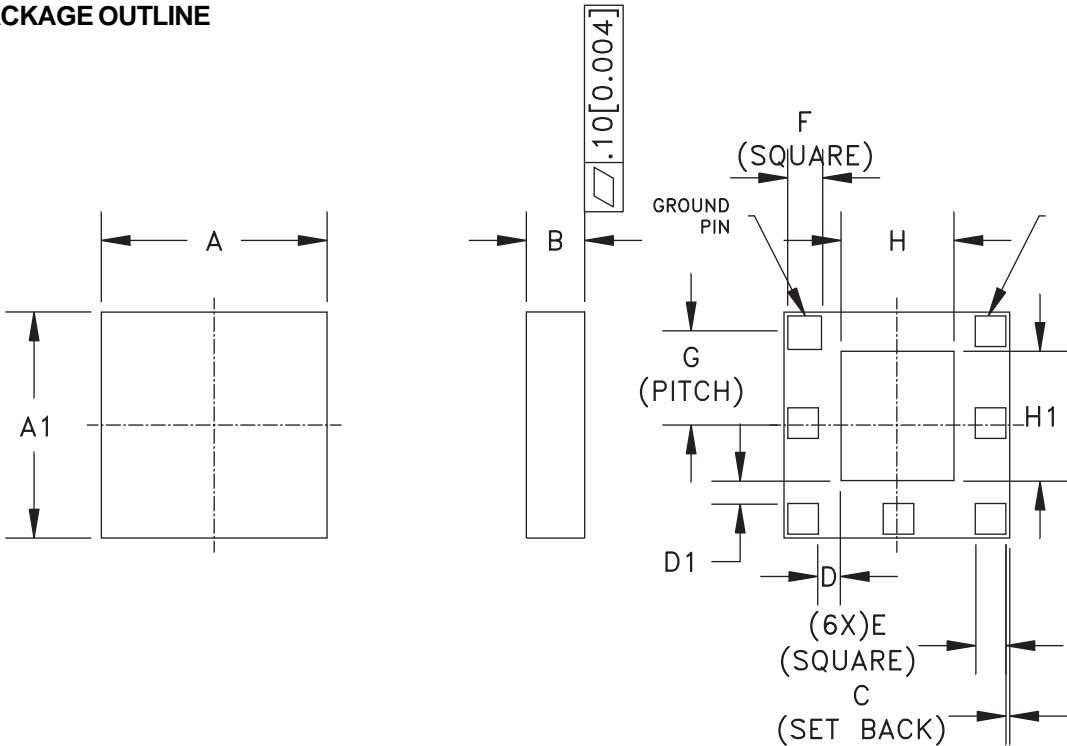

Figure 36: Application Circuit Schematic

PACKAGE OUTLINE



SYMBOL	MILLIMETERS			INCHES			NOTE
	MIN.	NOM.	MAX.	MIN.	NOM.	MAX.	
A	5.88	6.00	6.12	0.231	0.236	0.241	-
A1	5.88	6.00	6.12	0.231	0.236	0.241	-
B	1.30	1.55	1.70	0.051	0.061	0.067	-
C	-	0.10	-	-	0.004	-	-
D	-	0.60	-	-	0.024	-	-
D1	-	0.60	-	-	0.024	-	-
E	-	0.81	-	-	0.032	-	-
F	-	0.89	-	-	0.035	-	-
G	2.50 BSC			0.098 BSC			3
H	-	3.00	-	-	0.118	-	-
H1	-	3.42	-	-	0.135	-	-

NOTES:

1. CONTROLLING DIMENSIONS: MILLIMETERS
2. UNLESS SPECIFIED TOLERANCE=±0.076[0.003].
3. REFERENCE ONLY.

Figure 37: M5 Package Outline - 7 Pin 6mm x 6mm Surface Mount Module (High Band)

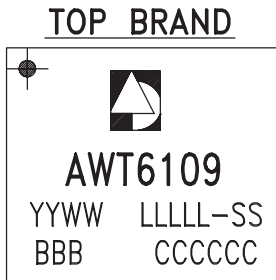

NOTES:

1. ANADIGICS LOGO SIZE: X=0.080±0.010 Y=0.095±0.010
2. PART #: AWT6109
3. YEAR AND WORK WEEK: YYWW: YY = YEAR, WW = WORK WEEK
4. LOT - Wafer I.D.: LLLL-SS = Wafer/Lot I.D.
5. PIN 1 INDICATOR: MOLD NOTCH -or- INK DOT
6. BOM #: BBB
7. COUNTRY CODE: CCCCC
8. TYPE : ELITE
 SIZE : AS LARGE AS POSSIBLE
 COLOR : WHITE or SILVER

Figure 38: Branding Specification

COMPONENT PACKAGING

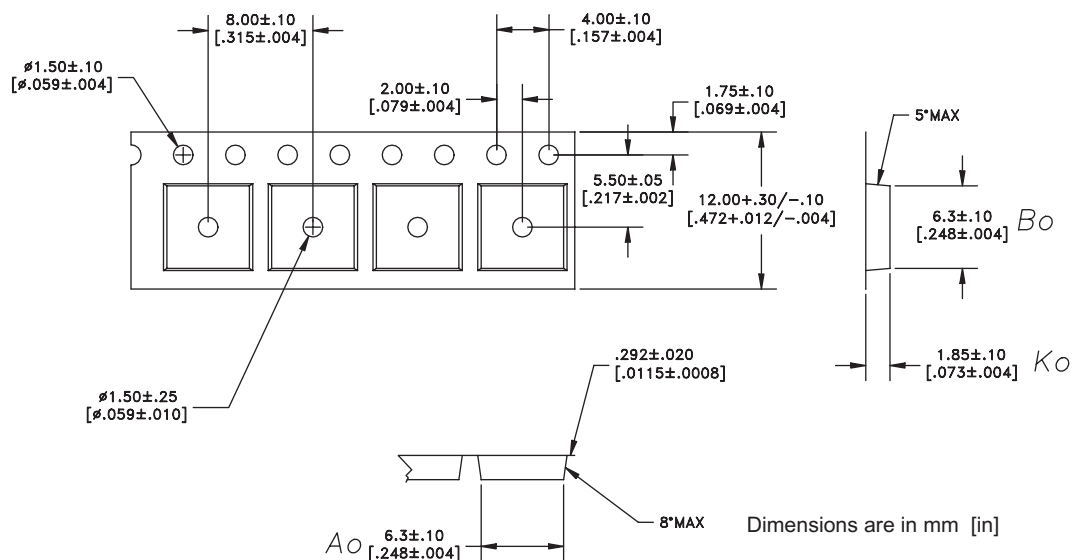

Figure 39: Tape & Reel Packaging

Table 5: Tape & Reel Dimensions

PACKAGE TYPE	TAPE WIDTH	POCKET PITCH	REEL CAPACITY	MAX REEL DIA
6mm X 6mm	12mm	8mm	2500	13"

AWT6109

NOTES

NOTES

ORDERING INFORMATION

ORDER NUMBER	TEMPERATURE RANGE	PACKAGE DESCRIPTION	COMPONENT PACKAGING
AWT6109M5P8	-30 °C to +110 °C	7 Pin 6mm x 6mm Surface Mount Module	Tape and Reel, 2500 pieces per reel

**ANADIGICS, Inc.**

141 Mount Bethel Road

Warren, New Jersey 07059, U.S.A.

Tel: +1 (908) 668-5000

Fax: +1 (908) 668-5132

URL: <http://www.anadigics.com>E:mail: Mktg@anadigics.com**IMPORTANT NOTICE**

ANADIGICS, Inc. reserves the right to make changes to its products or to discontinue any product at any time without notice. The product specifications contained in Advanced Product Information sheets and Preliminary Data Sheets are subject to change prior to a product's formal introduction. Information in Data Sheets have been carefully checked and are assumed to be reliable; however, ANADIGICS assumes no responsibilities for inaccuracies. ANADIGICS strongly urges customers to verify that the information they are using is current before placing orders.

WARNING

ANADIGICS products are not intended for use in life support appliances, devices, or systems. Use of an ANADIGICS product in any such application without written consent is prohibited.