

FEATURES

- InGaP HBT Technology
- High Efficiency: 54% AMPS, 38% CDMA
- Low Quiescent Current: 50 mA
- Low Leakage Current in Shutdown Mode: $<5 \mu\text{A}$
- Optimized for a 50Ω System
- Low Profile Surface Mount Package: 1.56mm Max
- CDMA 1XRTT Compliant
- CDMA 1xEV-DO Compliant
- RoHS Compliant Package Option, 250 °C MSL-3

APPLICATIONS

- Single Mode CDMA Wireless Handsets
- Dual Mode AMPS/CDMA Wireless Handsets

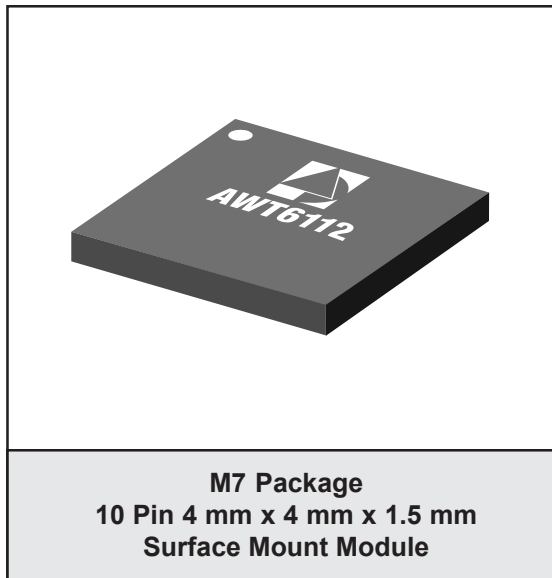

PRODUCT DESCRIPTION

The AWT6112 is a high power, high efficiency amplifier module for dual mode AMPS/CDMA wireless handset applications. The device is manufactured on an advanced InGaP HBT MMIC technology offering state-of-the-art reliability, temperature stability, and ruggedness. Selectable bias modes that optimize efficiency for different

output power levels, and a shutdown mode with low leakage current, serve to increase handset talk and standby time. The self contained 4 mm x 4 mm x 1.5 mm surface mount package incorporates matching networks optimized for output power, efficiency and linearity in a 50Ω system.

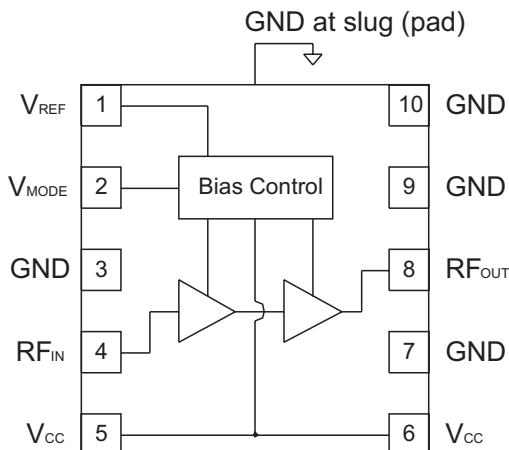

Figure 1: Block Diagram

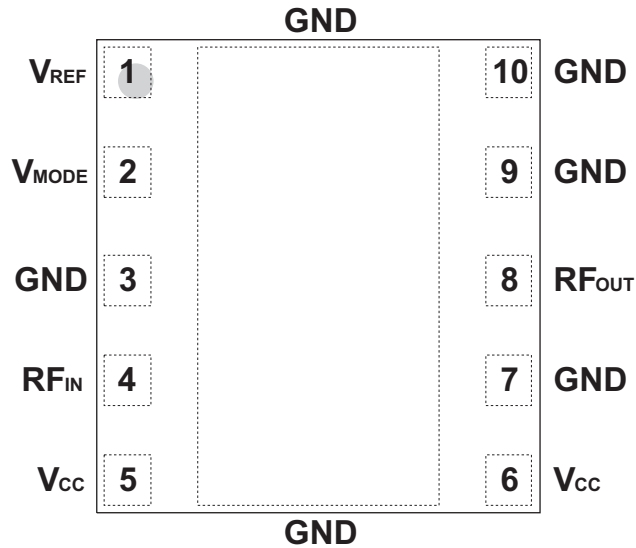

Figure 2: Pinout (X-ray Top View)

Table 1: Pin Description

PIN	NAME	DESCRIPTION
1	V _{REF}	Reference Voltage
2	V _{MODE}	Mode Control
3	GND	Ground
4	RF _{IN}	RF Input
5	V _{CC}	Supply Voltage
6	V _{CC}	Supply Voltage
7	GND	Ground
8	RF _{OUT}	RF Output
9	GND	Ground
10	GND	Ground

ELECTRICAL CHARACTERISTICS

Table 2: Absolute Minimum and Maximum Ratings

PARAMETER	MIN	MAX	UNIT
Supply Voltage (V_{CC})			
DC Only	0	+8	V
RF Drive \leq +5 dBm	0	+6 ⁽¹⁾	
Mode Control Voltage (V_{MODE})	0	+3.5	V
Reference Voltage (V_{REF})	0	+3.5	V
RF Input Power (P_{IN})	-	+10	dBm
Storage Temperature (T_{STG})	-40	+150	°C

Stresses in excess of the absolute ratings may cause permanent damage. Functional operation is not implied under these conditions. Exposure to absolute ratings for extended periods of time may adversely affect reliability.

Notes:

(1) $VSWR \leq 2:1$

Table 3: Operating Ranges

PARAMETER	MIN	TYP	MAX	UNIT	COMMENTS
Operating Frequency (f)	824	-	849	MHz	
Supply Voltage (V_{CC})	+3.2	+3.4	+4.2	V	
Reference Voltage (V_{REF})	+2.75 0	+2.85 -	+3.1 +0.5	V	PA "on" PA "shut down"
Mode Control Voltage (V_{MODE})	+2.5 0	+2.85 -	+3.1 +0.5	V	Low Bias Mode High Bias Mode
RF Output Power (P_{OUT})	+30.5 ⁽¹⁾ +27.5 ⁽¹⁾	+31.0 +28.0	- -	dBm	AMPS Mode CDMA Mode
Case Temperature (T_C)	-30	-	+85	°C	

The device may be operated safely over these conditions; however, parametric performance is guaranteed only over the conditions defined in the electrical specifications.

Notes:

(1) For operation at $T_C = 100$ °C, P_{OUT} is derated an additional 0.5 dB for $+3.2 \text{ V} \leq V_{CC} \leq +3.4 \text{ V}$.

Table 4: Electrical Specifications - AMPS Operation
 (T_C = +25 °C, V_{CC} = +3.4 V, V_{REF} = +2.85 V, V_{MODE} = +2.85 V, P_{OUT} = +31 dBm, 50 Ω system)

PARAMETER	MIN	TYP	MAX	UNIT	COMMENTS
Gain	25	26.5	29	dB	
Gain Variation	-	0.3	0.75	dB	
Power-Added Efficiency	50	54	-	%	
Quiescent Current (I _q)	-	49	60	mA	
Reference Current	-	2.3	4.0	mA	through V _{REF} pin
Mode Control Current	-	0.35	0.7	mA	through V _{MODE} pin
Leakage Current	-	<1	5	μA	V _{CC} = +4.2 V, V _{REF} = 0 V, V _{MODE} = 0 V
Noise in Receive Band	-	-135	-133	dBm/Hz	869 MHz to 894 MHz
Harmonics 2fo 3fo, 4fo	- - -	-40 -55	-30 -30	dBc	
Input Impedance	-	-	2:1	VSWR	
Spurious Output Level (all spurious outputs)	-	-	-65	dBc	P _{OUT} ≤ +31 dBm In-band load VSWR < 8:1 Out-of-band load VSWR < 8:1 Applies over all voltage and temperature operating ranges
Load mismatch stress with no permanent degradation or failure	8:1	-	-	VSWR	V _{CC} = +5.0 V P _{IN} = +5 dBm Applies over full operating temperature ranges

Table 5: Electrical Specifications - CDMA Operation
 (T_C = +25 °C, V_{CC} = +3.4 V, V_{REF} = +2.85 V, 50 Ω system)

PARAMETER	MIN	TYP	MAX	UNIT	COMMENTS
Gain	26 24	27.5 26.5	30 28	dB	P _{OUT} ≤ +28 dBm, V _{MODE} = 0 V P _{OUT} ≤ +16 dBm, V _{MODE} = 2.85 V
Adjacent Channel Power at ±885 kHz offset ⁽¹⁾ Primary Channel BW = 1.23 MHz Adjacent Channel BW = 30 kHz	- -	-49 -48	-47 -46	dB	P _{OUT} ≤ +28 dBm, V _{MODE} = 0 V P _{OUT} ≤ +16 dBm, V _{MODE} = 2.85 V
Adjacent Channel Power at ±1.98 MHz offset Primary Channel BW = 1.23 MHz Adjacent Channel BW = 30 kHz	- -	-58 -68	-56 -57	dB	P _{OUT} ≤ +28 dBm, V _{MODE} = 0 V P _{OUT} ≤ +16 dBm, V _{MODE} = 2.85 V
Power-Added Efficiency ⁽¹⁾	37 8	38.5 8.5	- -	%	P _{OUT} = +28 dBm, V _{MODE} = 0 V P _{OUT} = +16 dBm, V _{MODE} = +2.85 V
Quiescent Current (I _q)	-	78 49	95 60	mA	V _{MODE} = 0 V V _{MODE} = +2.85 V
Reference Current	-	2.3	4.0	mA	through V _{REF} pin
Mode Control Current	-	0.35	0.7	mA	through V _{MODE} pin,
Leakage Current	-	<1	5	μA	V _{CC} = +4.2 V, V _{REF} = 0 V, V _{MODE} = 0 V
Noise in Receive Band	-	-135	-132	dBm/Hz	869 MHz to 894 MHz
Harmonics 2f _o 3f _o , 4f _o	- -	-45 -55	-30 -30	dBc	
Input Impedance	-	-	2:1	VSWR	
Spurious Output Level (all spurious outputs)	-	-	-65	dBc	P _{OUT} ≤ +28 dBm In-band load VSWR < 8:1 Out-of-band load VSWR < 8:1 Applies over all voltage and temperature operating ranges
Load mismatch stress with no permanent degradation or failure	8:1	-	-	VSWR	V _{CC} = +5.0 V, P _{IN} = +5 dBm Applies over full operating temperature range

Notes:

(1) PAE and ACP limit applies at 836.5 MHz.

PERFORMANCE DATA

Figure 3: PAE vs. Frequency
+3.4 V Supply, Low Bias Mode
 (T_C = +25 °C, V_{CC} = +3.4 V, V_{REF} = +2.85 V,
 V_{MODE} = +2.85 V, P_{OUT} = +16 dBm)

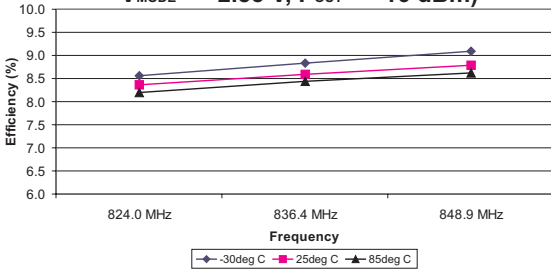

Figure 4: ACP2 vs. Frequency
+3.4 V Supply, Low Bias Mode
 (T_C = +25 °C, V_{CC} = +3.4 V, V_{REF} = +2.85 V,
 V_{MODE} = +2.85 V, P_{OUT} = +16 dBm)

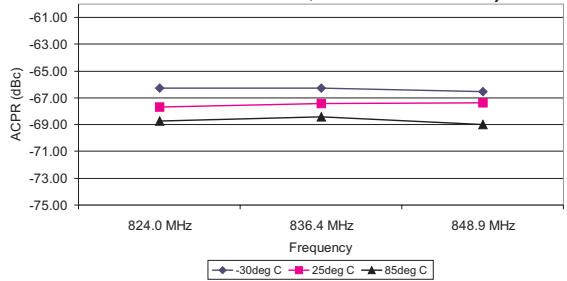

Figure 5: ACP1 vs. Frequency
+3.4 V Supply, Low Bias Mode
 (T_C = +25 °C, V_{CC} = +3.4 V, V_{REF} = +2.85 V,
 V_{MODE} = +2.85 V, P_{OUT} = +16 dBm)

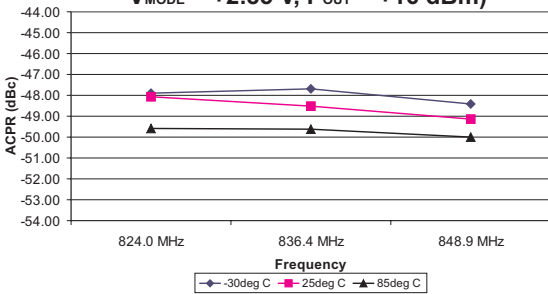

Figure 6: ACP1 vs. Frequency
+3.4 V Supply, High Bias Mode
 (T_C = +25 °C, V_{CC} = +3.4 V, V_{REF} = +2.85 V,
 V_{MODE} = 0 V, P_{OUT} = +28 dBm)

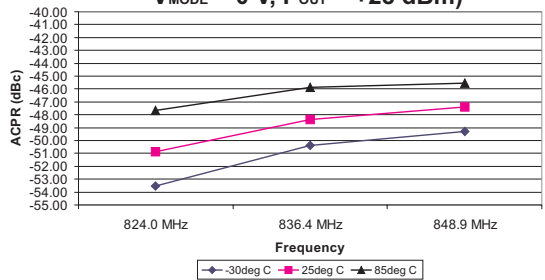

Figure 7: PAE vs. Frequency
+3.4 V Supply, High Bias Mode
 (T_C = +25 °C, V_{CC} = +3.4 V, V_{REF} = +2.85 V,
 V_{MODE} = 0 V, P_{OUT} = +28 dBm)

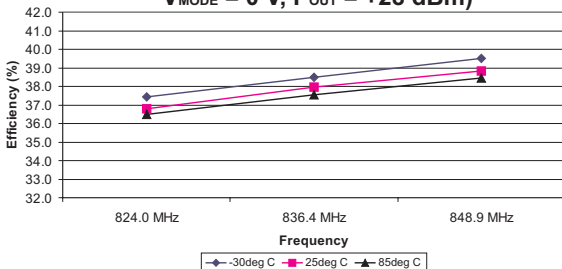

Figure 8: ACP2 vs. Frequency
+3.4 V Supply, High Bias Mode
 (T_C = +25 °C, V_{CC} = +3.4 V, V_{REF} = +2.85 V,
 V_{MODE} = 0 V, P_{OUT} = +28 dBm)

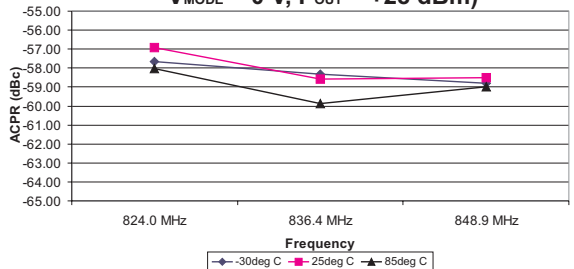

Figure 9: Input Power vs. Output Power Over Frequency
 ($T_C = +25\text{ }^\circ\text{C}$, $V_{CC} = +3.4\text{ V}$, $V_{REF} = +2.85\text{ V}$)

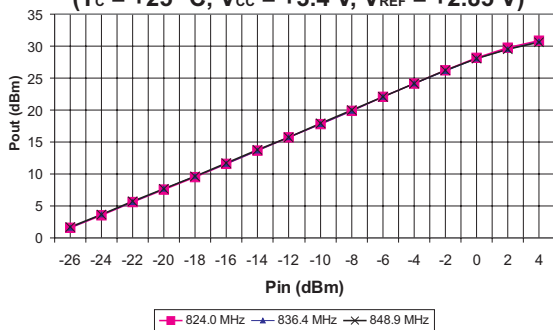

Figure 10: ACP1 and ACP2 vs. Output Power Over Frequency
 ($T_C = +25\text{ }^\circ\text{C}$, $V_{CC} = +3.4\text{ V}$, $V_{REF} = +2.85\text{ V}$)

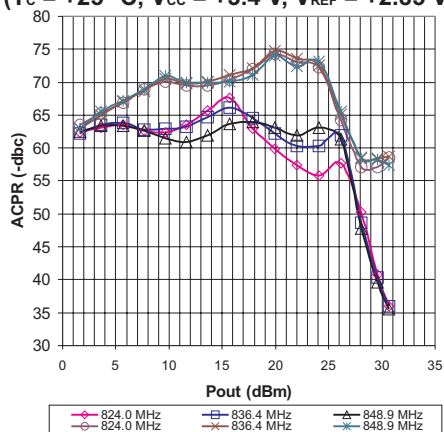
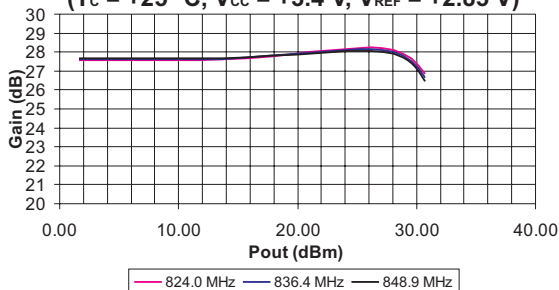

Figure 11: Large Signal Gain vs. Output Power Over Frequency
 ($T_C = +25\text{ }^\circ\text{C}$, $V_{CC} = +3.4\text{ V}$, $V_{REF} = +2.85\text{ V}$)



APPLICATION INFORMATION

To ensure proper performance, refer to all related Application Notes on the ANADIGICS web site: <http://www.anadigics.com>

Shutdown Mode

The power amplifier may be placed in a shutdown mode by applying a logic low levels (see Operating Ranges table) to both the V_{REF} and V_{MODE} voltages.

Bias Modes

The power amplifier may be placed in either a Low Bias mode or a High Bias mode by applying the appropriate logic level (see Operating Ranges table) to the V_{MODE} voltage. The Bias Control table lists the recommended modes of operation for various applications.

Table 6: Bias Control

APPLICATION	P_{OUT} LEVELS	BIAS MODE	V_{REF}	V_{MODE}
AMPS	(all)	Low	+2.85 V	+2.85 V
CDMA - low power	≤+16 dBm	Low	+2.85 V	+2.85 V
CDMA - high power	>+16 dBm	High	+2.85 V	0 V
Shutdown	-	Shutdown	0 V	0 V

PACKAGE OUTLINE

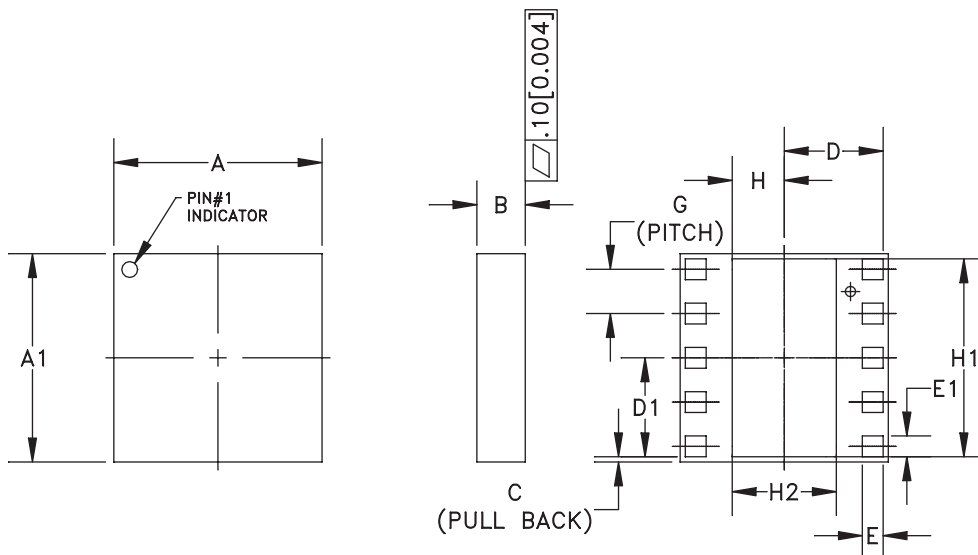

DIM.	MILLIMETERS			INCHES			NOTE
	MIN.	NOM.	MAX.	MIN.	NOM.	MAX.	
A	3.88	4.00	4.12	0.152	0.157	0.162	-
A1	3.88	4.00	4.12	0.152	0.157	0.162	-
B	1.26	1.41	1.56	0.049	0.055	0.061	-
C	-	0.10	-	-	0.004	-	-
D	-	1.90	-	-	0.075	-	-
D1	-	1.90	-	-	0.075	-	-
E	0.35	0.40	0.45	0.013	0.015	0.017	-
E1	0.35	0.40	0.45	0.013	0.015	0.017	-
G	0.85 BSC			0.033 BSC			-
H	-	1.00	-	-	0.039	-	-
H1	-	3.80	-	-	0.149	-	-
H2	-	2.00	-	-	0.078	-	-

NOTES:

1. CONTROLLING DIMENSIONS: MILLIMETERS
2. UNLESS SPECIFIED TOLERANCE=±0.076[0.003].

Figure 12: M7 Package Outline - 10 Pin 4mm x 4mm Surface Mount Module

TOP BRAND

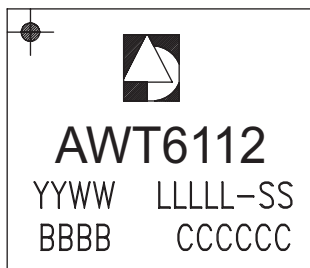

NOTES:

1. ANADIGICS LOGO SIZE: X=0.040±0.010 Y=0.048±0.010
2. PART # AWT6112
3. YEAR AND WORK WEEK: YYWW: YY = YEAR, WW = WORK WEEK
4. LOT - WAFER I.D.: LLLLL = LOT#, SS = WAFER I.D.
5. PIN 1 INDICATOR: MOLD NOTCH -or- INK DOT
6. BOM # BBBB
7. COUNTRY CODE: CCCCC
8. TYPE : ELITE
SIZE : AS LARGE AS POSSIBLE
WHITE or SILVER

Figure 13: Branding Specification

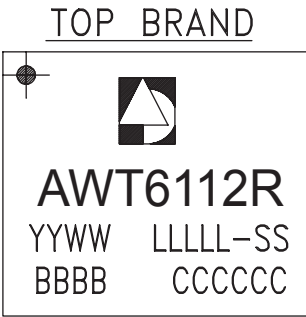

NOTES:

- | | |
|-------------------------|------------------------------------|
| 1. ANADIGICS LOGO SIZE: | X=0.040±0.010 Y=0.048±0.010 |
| 2. PART # | AWT6112R |
| 3. YEAR AND WORK WEEK: | YYWW: YY = YEAR, WW = WORK WEEK |
| 4. LOT - WAFER I.D.: | LLLLL = LOT#, SS = WAFER I.D. |
| 5. PIN 1 INDICATOR: | MOLD NOTCH -or- INK DOT |
| 6. BOM # | BBBB |
| 7. COUNTRY CODE: | CCCCC |
| 8. TYPE : | ELITE |
| SIZE : | AS LARGE AS POSSIBLE |
| | WHITE or SILVER |

Figure 14: Branding Specification

COMPONENT PACKAGING

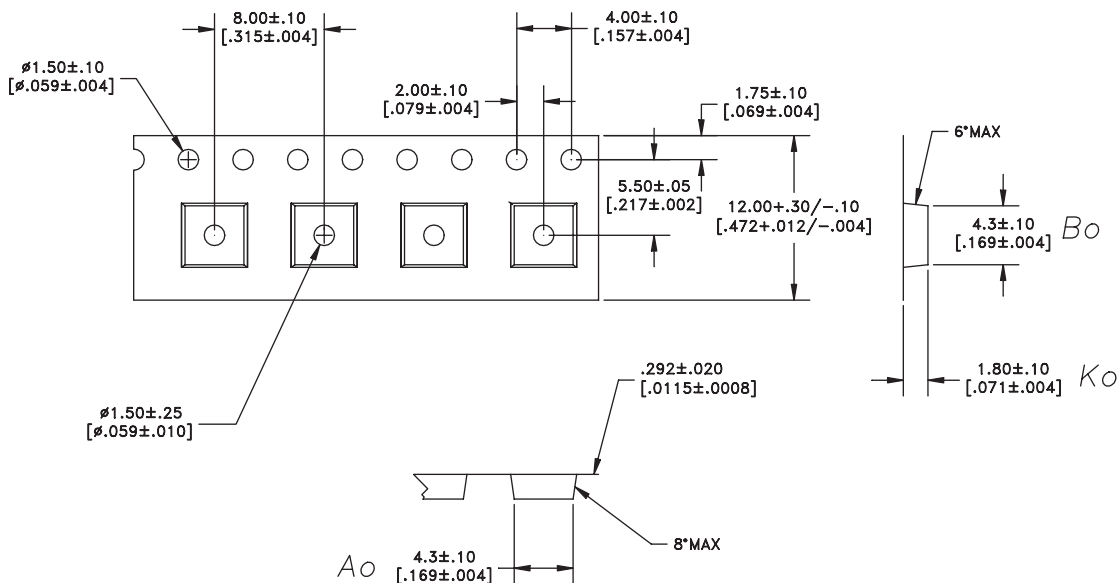

DIMENSIONS ARE IN MILLIMETERS [INCHES]
STANDARD TOLERANCES

Figure 15: Tape & Reel Packaging

Table 7: Tape & Reel Dimensions

PACKAGE TYPE	TAPE WIDTH	POCKET PITCH	REEL CAPACITY	MAX REEL DIA
4 mm x 4 mm x 1.5 mm	12 mm	8 mm	2500	13"

ORDERING INFORMATION

ORDER NUMBER	TEMPERATURE RANGE	PACKAGE DESCRIPTION	COMPONENT PACKAGING
AWT6112M7P8	-30 °C to +85 °C	10 Pin 4mm x 4mm Surface Mount Module	Tape and Reel, 2500 pieces per Reel
AWT6112RM7P8	-30 °C to +85 °C	RoHS Compliant 10 Pin 4 mm x 4 mm x 1.5 mm Surface Mount Module	Tape and Reel, 2500 pieces per Reel

**ANADIGICS, Inc.**

141 Mount Bethel Road
Warren, New Jersey 07059, U.S.A.

Tel: +1 (908) 668-5000

Fax: +1 (908) 668-5132

URL: <http://www.anadigics.com>

E-mail: Mktg@anadigics.com

IMPORTANT NOTICE

ANADIGICS, Inc. reserves the right to make changes to its products or to discontinue any product at any time without notice. The product specifications contained in Advanced Product Information sheets and Preliminary Data Sheets are subject to change prior to a product's formal introduction. Information in Data Sheets have been carefully checked and are assumed to be reliable; however, ANADIGICS assumes no responsibilities for inaccuracies. ANADIGICS strongly urges customers to verify that the information they are using is current before placing orders.

WARNING

ANADIGICS products are not intended for use in life support appliances, devices or systems. Use of an ANADIGICS product in any such application without written consent is prohibited.