



AWT921S11

Integrated High Power Amp 900 MHz
Advanced Product information
Rev. 6

DESCRIPTION

The AWT921 is a monolithic amplifier for use in communication systems that require high gain and output intercept point. This device has been specifically designed for multi carrier and micro cell base station applications.

FEATURES

- High output power levels
- High Efficiency
- True Surface Mount Package with Integrated Heat Slug
- Internal Bias Circuit Requiring Nominal Input Voltages $\pm 10\%$
- Low Cost
- Off Chip Output Matching Circuit Allows Application Optimization



S11
SSOP-28 Wide Body
28 Pin Wide Body w/ Heat Slug

ABSOLUTE MAXIMUM RATINGS

| PIN | SIGNAL | MAX RATING | PIN | SIGNAL | MAX RATING |
|-----|-----------|-------------------|-------------------------|-----------|--------------|
| 2 | V_{DD} | $+7V_{DC}$ | 11 | V_{REF} | $+7 V_{DC}$ |
| 3 | RF_{IN} | $+20 \text{ dBm}$ | 12 | V_{SS} | $-7 V_{DC}$ |
| 4,5 | V_{D1} | $+10 V_{DC}$ | 18,19,20,21,22,23,24,25 | V_{D3} | $+10 V_{DC}$ |
| 8,9 | V_{D2} | $+10 V_{DC}$ | | | |

Operating Temperature: -30 to $+85^\circ \text{C}$

Storage Temperature: -55 to $+100^\circ \text{C}$

ELECTRICAL SPECIFICATIONS: ⁽¹⁾(Pin +12 dBm, fo = 925-960 MHz, V_{DS1} = V_{DS2} = V_{DS3} = 8.5V, V_{SS} = -3V, V_{REF} = +5V, V_{DD} = +5V, Tc=25°C, 50Ω System ⁽²⁾)

| PARAMETER | SYMBOL | MIN | TYP | MAX | UNITS |
|---|--|--------------|-------------------|-----|-----------------------------|
| Frequency | fo | 925 | - | 960 | MHz |
| Power Output | P _{OUT} | - | +39 | - | dBm |
| Power Added Efficiency | η _{Eff} | - | 40 | - | % |
| Gain @ P _{OUT} = +39 dBm @ P _{OUT} = +30 dBm | PG | - | 29 30 | - | dB |
| Harmonics ⁽³⁾ 2nd 3rd 4th | - | - | 37 47 50 | - | dBc |
| Stability: -60 dBc all spurious outputs relative to desired signal | - | - | 3:1 | - | VSWR load, all phase angles |
| Bias supply currents | I _{SS} I _{REF} I _{DD} | - | 8 1.2 8 | - | mA mA mA |
| Quiescent Currents | I _{DQ1} I _{DQ2} I _{DQ3} | - | 100 250 200 | - | mA mA mA |
| Input Return Loss | | 10 | - | - | dB |
| Gain Flatness vs. Frequency @ P _{out} = +39 dBm @ P _{out} = +30 dBm | ΔPG | ±0.5 ±0.5 | - | - | dB dB |
| Thermal Resistance ⁴ | - | - | 4.5 | - | C/W |

NOTES:

- As measured in ANADIGICS test fixture, see application section
- 50Ω Measurement system after off chip matching circuit, input terminated in 50Ω
- Measured at P_{out} = +39 dBm
- Thermal resistance for junction to bottom of slug. Q_{jc} = (T_j - T_c) / ((I_{D1} + I_{D2} + I_{D3}) * V_{SUP} - P_{OUT})

CHARACTERIZATION DATA ⁽¹⁾ -

Conditions unless otherwise stated (Pin +12 dBm, fo = 925-960 MHz, V_{DS1} = V_{DS2} = V_{DS3} = 8.5V, V_{SS} = -3V, V_{REF} = +5V, V_{DD} = +5V, Tc=25°C, 50 W system ⁽²⁾)

Pout & Eff vs. Pin

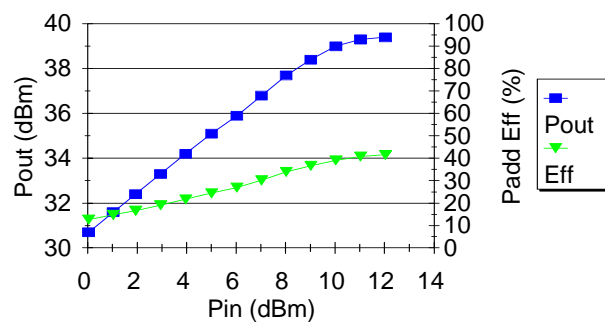

Pout & Eff vs. Frequency

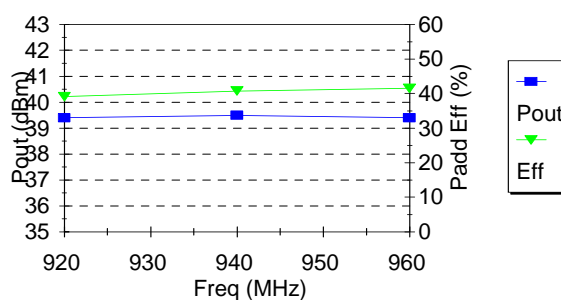

Pout vs. Supply Voltage

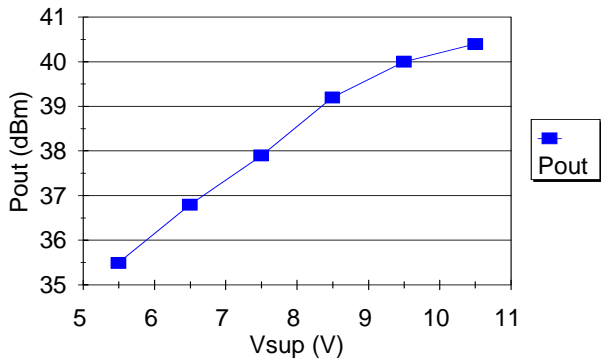

Idq3 vs Vdd

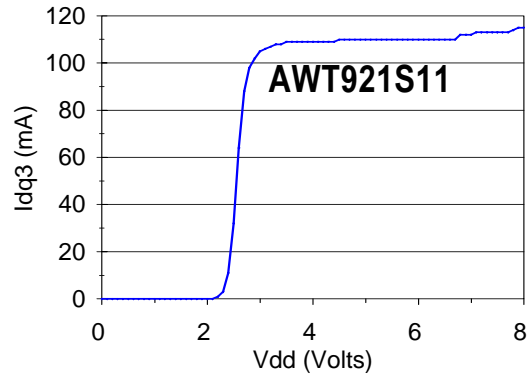

Idq3 vs Vref

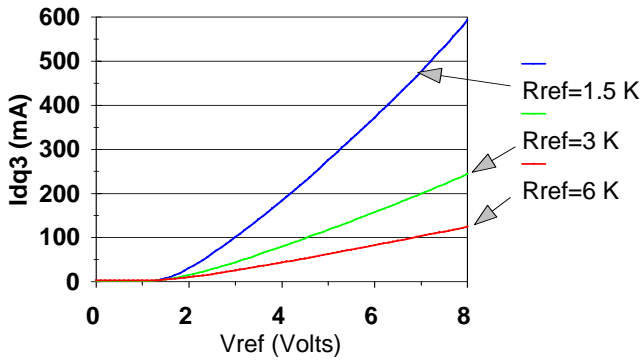

Idq3 vs Vss

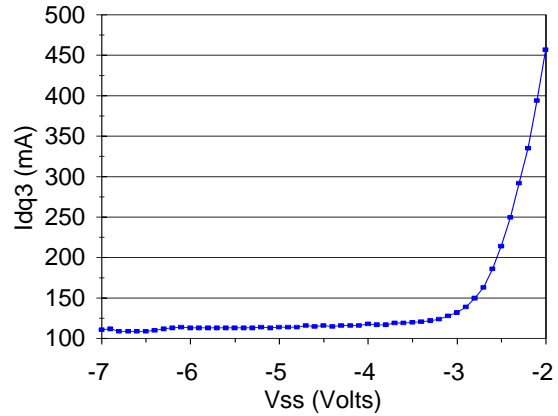

Notes:

- 1: As measured in ANADIGICS test fixture, see application section
- 2: 50Ω Measurement system after off chip matching circuit, input terminated in 50Ω

CHARACTERIZATION DATA: ⁽¹⁾

Conditions unless otherwise stated (Pin +12 dBm, fo = 925-960 MHz,
 $V_{DS1} = V_{DS2} = V_{DS3} = 8.5V$, $V_{SS} = -3V$, $V_{REF} = +5V$, $V_{DD} = +5V$, $T_c = 25^\circ C$, 50Ω system) ⁽²⁾

Bias Ckt Gain vs Vref

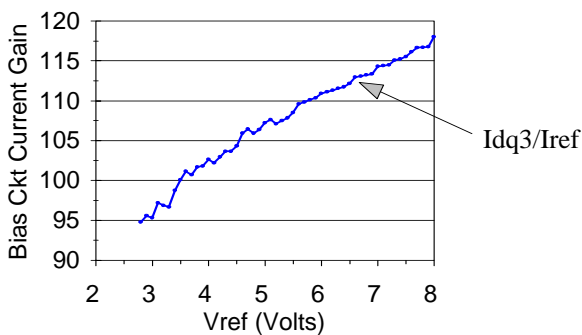

Iq3 & Iref vs Temperature

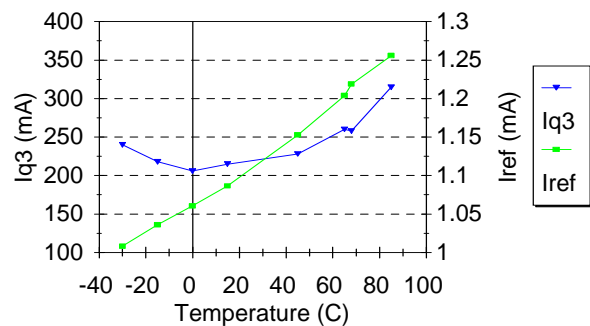

Pout,PG,& Eff vs Temperature

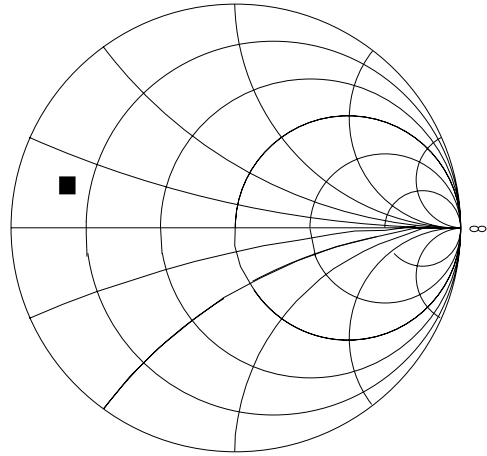
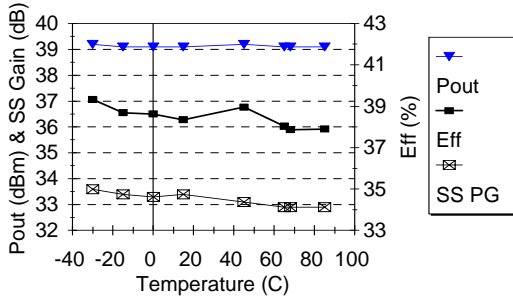

Load + 3.7 + 3.9 jΩ

Output Load Impedance as seen by the device

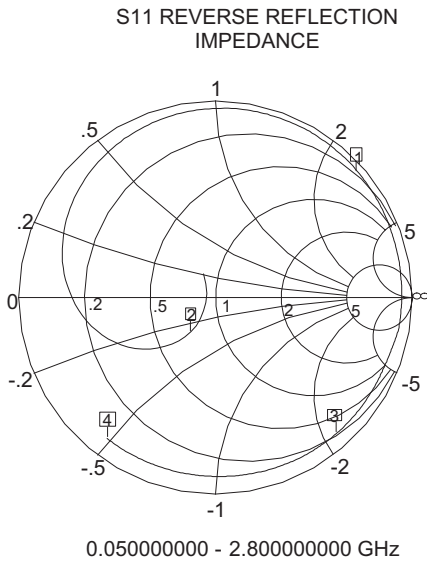

CH 4 - S11
REFERENCE PLANE
9.0821 cm

MARKER 1
0.957500000 GHz
7.074 Ω
131.906 jΩ

MARKER TO MAX
MARKER TO MIN

2 0.098125000 GHz
36.919 Ω
-13.501 jΩ

3 1.920000000 GHz
11.446 Ω
-111.641 jΩ

4 2.800000000 GHz
3.133 Ω
-24.550 jΩ

MARKER READOUT
FUNCTIONS

Impedance as seen by V_{DS1}

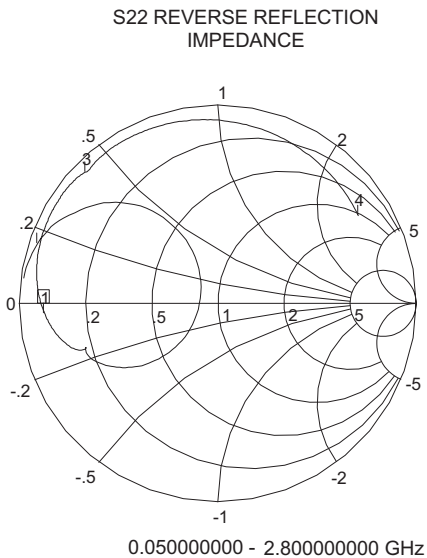

TRACE MEMORY
DISK OPERATIONS

CHANNEL 4

SAVE MEMORY
TO HARD DISK

SAVE MEMORY
TO FLOPPY DISK

RECALL MEMORY
FROM HARD DISK

RECALL MEM0ORY
FROM FLOPPY DISK

PRESS<ENTER>
TO SELECT

Output Impedance as seen by V_{DS3}

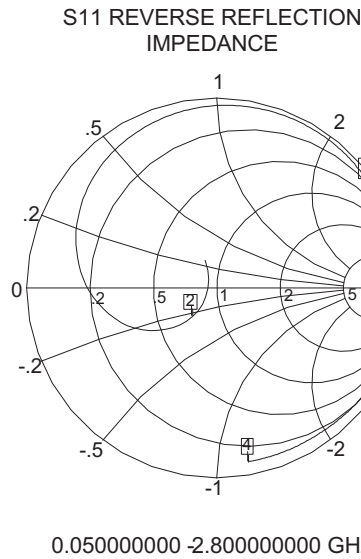

CH 4 - S11
REFERENCE PLANE
9.0821 cm

MARKER 1
0.957500000 GHz
7.659 Ω
161.181 j Ω

MARKER TO MAX
MARKER TO MIN

2 0.098125000 GHz
37.237 Ω
-11.817 j Ω

3 1.920000000 GHz
13.308 Ω
-171.126 j Ω

4 2.800000000 GHz
4.466 Ω
-60.044 j Ω

MARKER READOUT
FUNCTIONS

Impedance as seen V_{DS2}

PACKAGE OUTLINE DRAWING

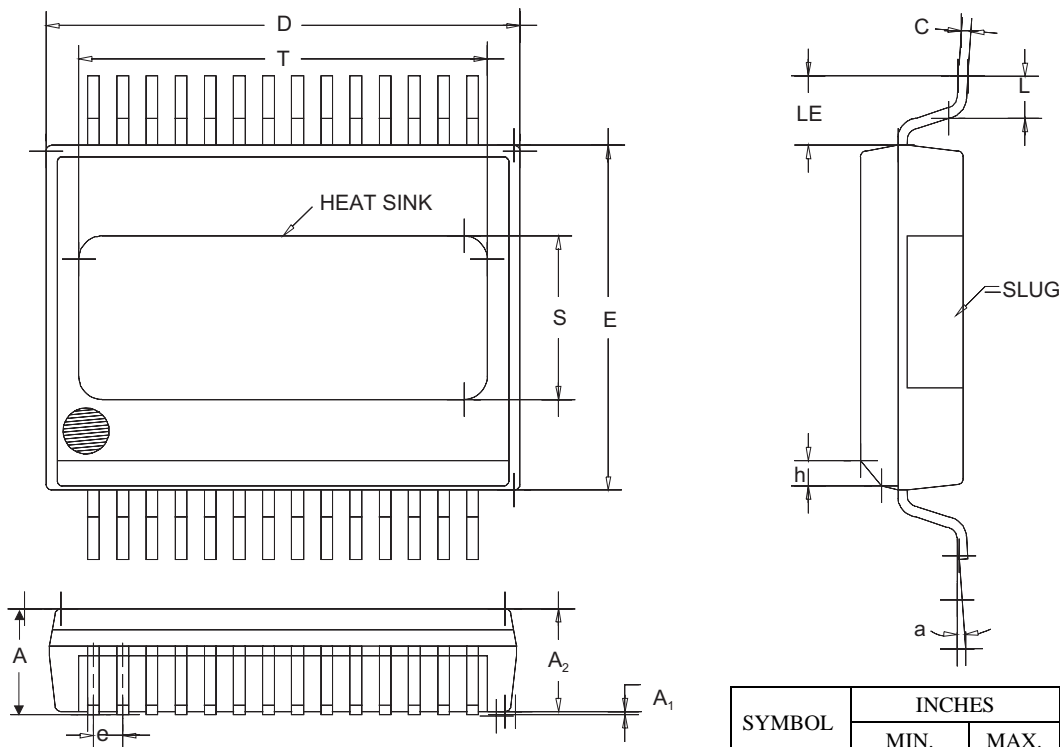

Notes:

1. Controlling dimensions : inches.
2. Dimension "d" does not include mold flash, protrusions or gate burrs. Mold flash, protrusions and gate burrs shall not exceed 0.006 (0.16mm).
3. Dimension "e" does not include inter-lead or protrusions. Inter-lead flash and protrusions shall not exceed 0.010 (0.25mm) per side.
4. Maximum lead twist/skew to be 0.002 (0.05mm).
5. Mold flash shall not extend more than 0.010 (0.25mm) on any edge of heat slug.

| SYMBOL | INCHES | | MILLIMETERS | | NOTE |
|----------------|--------|-------|-------------|-------|------|
| | MIN. | MAX. | MIN. | MAX. | |
| A | 0.087 | 0.093 | 2.21 | 2.36 | |
| A ₁ | 0.000 | 0.004 | 0.00 | 0.10 | |
| A ₂ | 0.087 | 0.089 | 2.21 | 2.25 | |
| B | 0.008 | 0.012 | 0.36 | 0.46 | |
| C | 0.007 | 0.009 | 0.18 | 0.25 | |
| D | 0.400 | 0.408 | 10.16 | 10.36 | 2 |
| E | 0.292 | 0.296 | 7.42 | 7.52 | 2 |
| e | 0.025 | BSC | 0.64 | BSC | 4 |
| H | 0.410 | 0.418 | 10.41 | 40.62 | |
| h | 0.018 | 0.024 | 0.48 | 0.61 | |
| L | 0.034 | 0.038 | 0.86 | 0.97 | |
| LE | 0.84 | | 1.37 | | |
| a | 0 | 8 | 0 | 8 | |
| S | 0.139 | 0.141 | 3.54 | 3.55 | 5 |
| T | 0.349 | 0.351 | 8.86 | 8.92 | 5 |

ANADIGICS, Inc.

35 Technology Drive
 Warren, New Jersey 07059
 Tel: (908) 668-5000 / Fax: (908) 668-5132
 Email: Mkg@anadigics.com
 www.anadigics.com

IMPORTANT NOTICE

ANADIGICS, Inc. reserves the right to make changes to its products or discontinue any product at any time without notice. The Advanced Product data sheets and product specifications contained in this data sheet are subject to change prior to a products formal introduction. The information in this data sheet has been carefully checked and is assumed to be reliable. However, ANADIGICS assumes no responsibility for inaccuracies. ANADIGICS strongly urges customers to verify that the information they are using is current before placing orders.

WARNING

ANADIGICS products are not intended for use in life support appliances, device, or systems. Use of an ANADIGICS product in any such application without written consent is prohibited.