

# B0530WS

**0.5 Amp  
Schottky Rectifier  
30 Volts**

## Features

- Lead Free Finish/RoHS Compliant ("P" Suffix designates RoHS Compliant. See ordering information)
- Extremely Low Thermal Resistance
- For Surface Mount Application and High Current Capability
- Higher Temp Soldering: 260°C for 10 Seconds At Terminals
- Epoxy meets UL 94 V-0 flammability rating
- Moisture Sensitivity Level 1

## Maximum Ratings

- Operating Temperature: -55°C to +125°C
- Storage Temperature: -55°C to +150°C
- Maximum Thermal Resistance: 5°C/W Junction to Lead
- Halogen free available upon request by adding suffix "-HF"

MCC Part Number	Device Marking	Maximum Recurrent Peak Reverse Voltage	Maximum RMS Voltage	Maximum DC Blocking Voltage
B0530WS	3 / SE	30V	21V	30V

## Electrical Characteristics @ 25°C Unless Otherwise Specified

Average Forward Current	$I_{F(AV)}$	0.5A	$T_J=90^\circ\text{C}$
Peak Forward Surge Current	$I_{FSM}$	5A	8.3ms half sine
Maximum Instantaneous Forward Voltage	$V_F$	0.55V	$I_{FM}=0.5A$ $T_J=25^\circ\text{C}$
Maximum DC Reverse Current At Rated DC Blocking Voltage	$I_R$	0.3mA	$T_A=25^\circ\text{C}$
Typical Junction Capacitance	$C_J$	30pF	Measured at 1.0MHz, $V_R=4.0V$
Power Dissipation	$P_D$	250mW	

## SOD323

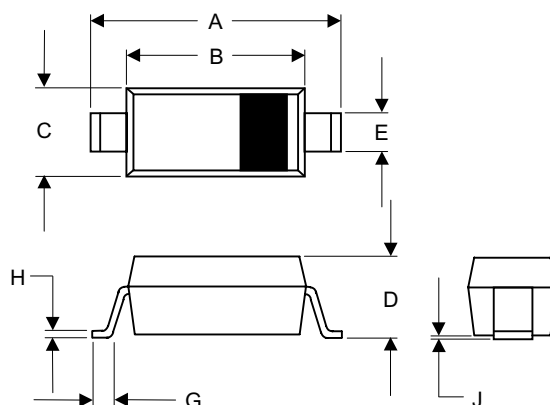

DIM	DIMENSIONS				NOTE
	INCHES		MM		
	MIN	MAX	MIN	MAX	
A	.090	.113	2.30	2.88	
B	.063	.071	1.60	1.80	
C	.045	.053	1.15	1.35	
D	.031	.049	0.80	1.24	
E	.010	.016	0.25	0.40	
G	.004	.018	0.10	0.45	
H	.004	.010	0.10	0.25	
J	-----	.006	-----	0.15	

### SUGGESTED SOLDER PAD LAYOUT

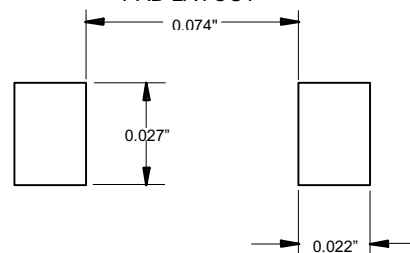

Figure 1  
 Typical Forward Characteristics

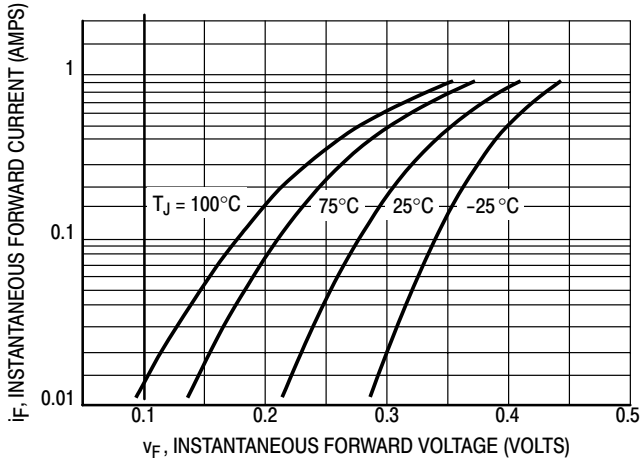

Figure 2  
 Typical Forward Characteristics

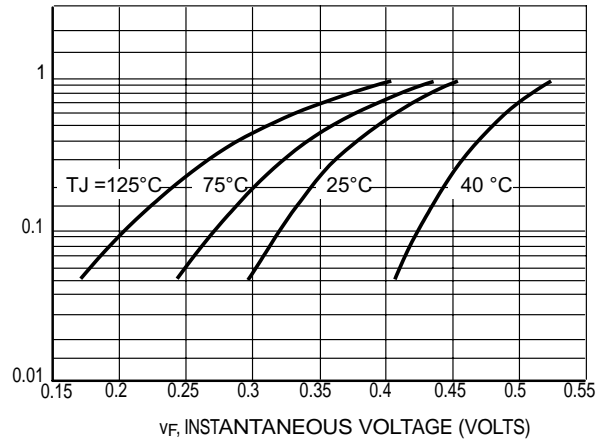

Figure 3  
 Typical Forward Characteristics

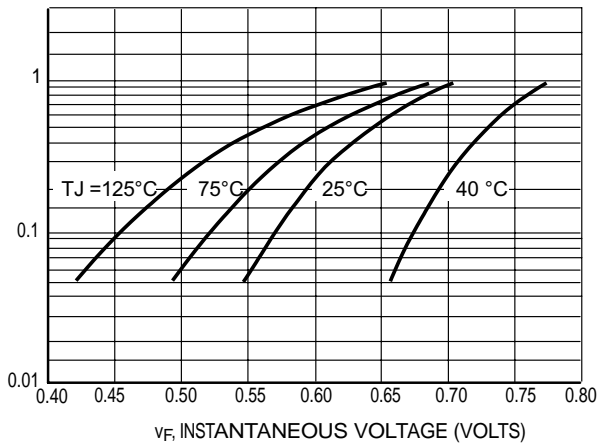
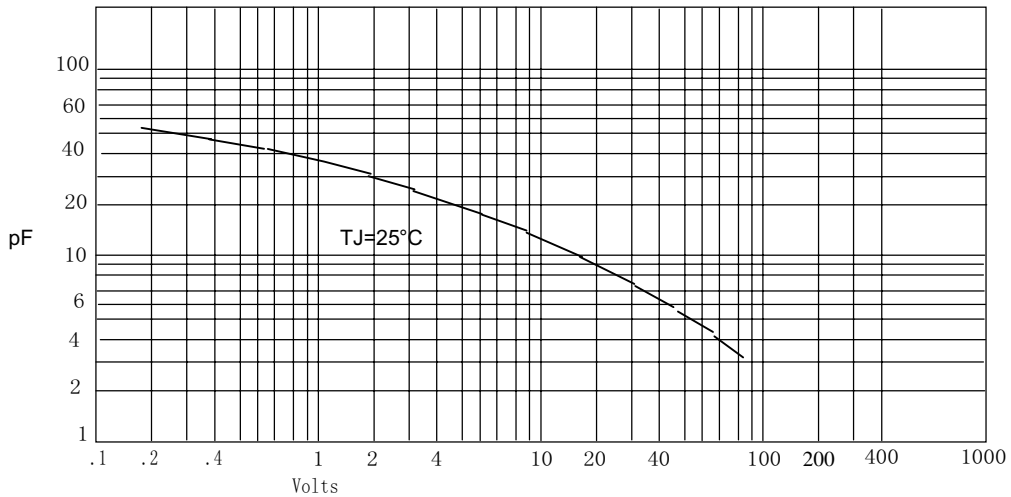
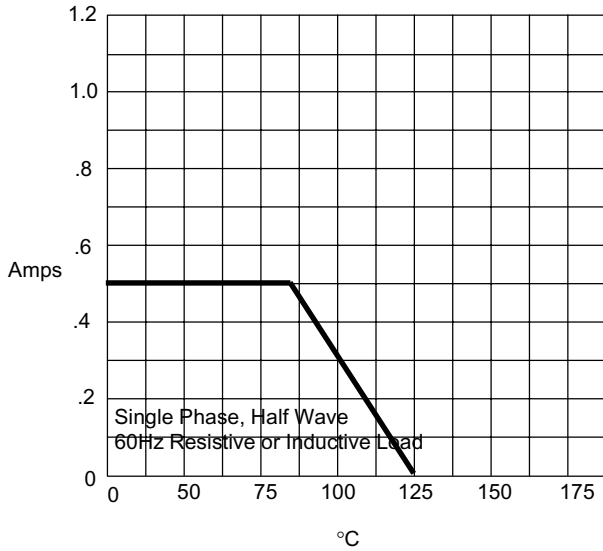

Figure 4  
 Junction Capacitance



# B0530WS

Figure 5  
Forward Derating Curve



Single Phase, Half Wave  
60Hz Resistive or Inductive Load

Average Forward Rectified Current - Amperes versus Ambient Temperature - °C

Figure 6  
Peak Forward Surge Current

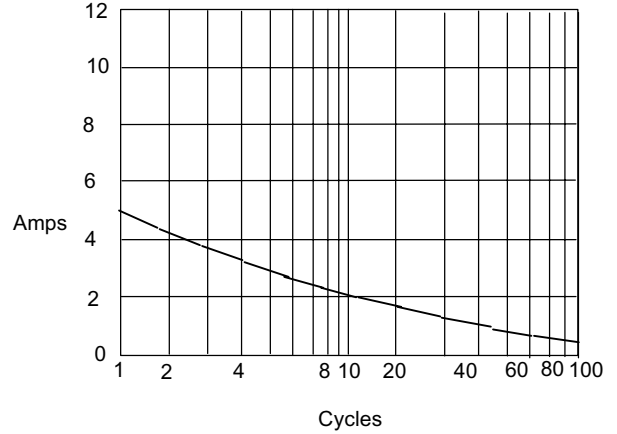

Peak Forward Surge Current - Amperes versus Number Of Cycles At 60Hz - Cycles



TM

Micro Commercial Components

### Ordering Information :

Device	Packing
Part Number-TP	Tape&Reel: 3Kpcs/Reel

Note : Adding "-HF" suffix for halogen free, eg. Part Number-TP-HF

#### \*\*\*IMPORTANT NOTICE\*\*\*

**Micro Commercial Components Corp.** reserves the right to make changes without further notice to any product herein to make corrections, modifications , enhancements , improvements , or other changes . **Micro Commercial Components Corp .** does not assume any liability arising out of the application or use of any product described herein; neither does it convey any license under its patent rights ,nor the rights of others . The user of products in such applications shall assume all risks of such use and will agree to hold **Micro Commercial Components Corp .** and all the companies whose products are represented on our website, harmless against all damages.

#### \*\*\*LIFE SUPPORT\*\*\*

MCC's products are not authorized for use as critical components in life support devices or systems without the express written approval of Micro Commercial Components Corporation.

#### \*\*\*CUSTOMER AWARENESS\*\*\*

Counterfeiting of semiconductor parts is a growing problem in the industry. Micro Commercial Components (MCC) is taking strong measures to protect ourselves and our customers from the proliferation of counterfeit parts. MCC strongly encourages customers to purchase MCC parts either directly from MCC or from Authorized MCC Distributors who are listed by country on our web page cited below. Products customers buy either from MCC directly or from Authorized MCC Distributors are genuine parts, have full traceability, meet MCC's quality standards for handling and storage. **MCC will not provide any warranty coverage or other assistance for parts bought from Unauthorized Sources.** MCC is committed to combat this global problem and encourage our customers to do their part in stopping this practice by buying direct or from authorized distributors.

[www.mccsemi.com](http://www.mccsemi.com)