

5.0A SINGLE-PHASE BRIDGE RECTIFIER

Features

- Diffused Junction
- Low Forward Voltage Drop
- High Current Capability
- High Reliability
- High Surge Current Capability
- High Case Dielectric Strength
- Ideal for Printed Circuit Boards

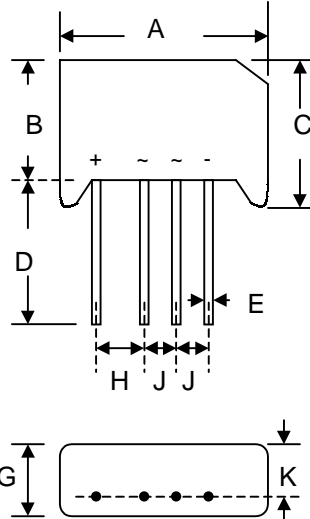

RS-5		
Dim	Min	Max
A	39.40	40.10
B	20.20	21.00
C	21.00	21.70
D	25.40	—
E	0.97 Ø	1.07 Ø
G	6.20	6.70
H	9.80	10.20
J	7.20	7.60
K	4.60	5.00
All Dimensions in mm		

Mechanical Data

- Case: RS-5, Molded Plastic
- Terminals: Plated Leads Solderable per MIL-STD-202, Method 208
- Polarity: As Marked on Body
- Weight: 9.8 grams (approx.)
- Mounting Position: Any
- Marking: Type Number
- **Lead Free: For RoHS / Lead Free Version, Add “-LF” Suffix to Part Number, See Page 4**

Maximum Ratings and Electrical Characteristics @ $T_A=25^\circ\text{C}$ unless otherwise specified

Single Phase, half wave, 60Hz, resistive or inductive load.
For capacitive load, derate current by 20%.

Characteristic	Symbol	B40C	B80C	B125C	B250C	B380C	B500C	Unit
		5000/3300	5000/3300	5000/3300	5000/3300	5000/3300	5000/3300	
Peak Repetitive Reverse Voltage Working Peak Reverse Voltage DC Blocking Voltage	V_{RRM} V_{RWM} V_R	100	200	300	600	900	1000	V
Recommend Input Voltage	V_{RMS}	40	80	125	250	380	500	V
Average Rectified Output Current @ $T_A = 45^\circ\text{C}$ (Note 1)	I_O	5.0						A
Non-Repetitive Peak Forward Surge Current 8.3ms Single half sine-wave superimposed on rated load (JEDEC Method)	I_{FSM}	250						A
Repetitive Peak Forward Surge Current	I_{FRM}	30						A
Forward Voltage per leg @ $I_F = 5.0\text{A}$	V_{FM}	1.0						V
Peak Reverse Current @ $T_C = 25^\circ\text{C}$ At Rated DC Blocking Voltage @ $T_C = 125^\circ\text{C}$	I_R	10 6.0						μA mA
Rating for Fusing ($t < 8.3\text{ms}$) (Note 2)	I^2t	110						A^2s
Typical Thermal Resistance per leg (Note 1)	$R_{\theta JA}$	2.6						$^\circ\text{C}/\text{W}$
Operating and Storage Temperature Range	T_j, T_{STG}	-55 to +150						$^\circ\text{C}$

Note: 1. Mounted on 200mm² metal chassis.
2. Non-repetitive for $t > 1\text{ms}$ and $< 8.3\text{ms}$.

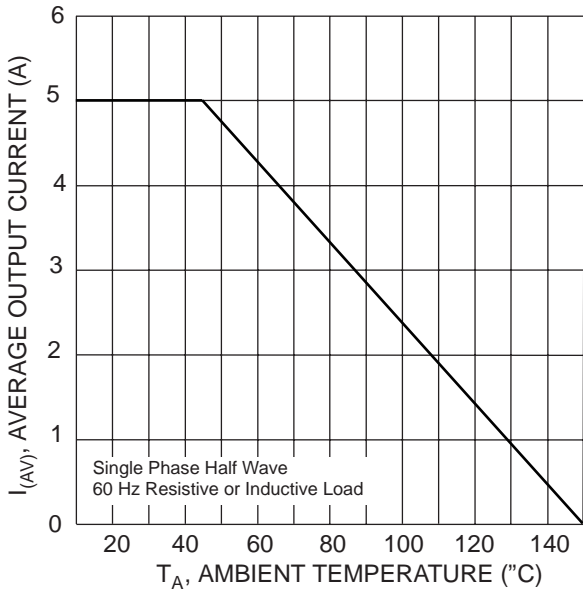

Fig. 1 Forward Current Derating Curve

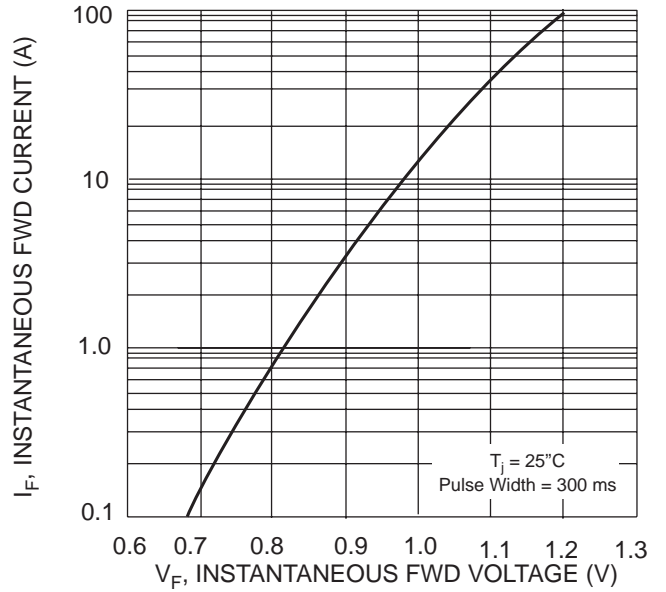

Fig. 2 Typical Forward Characteristics, per element

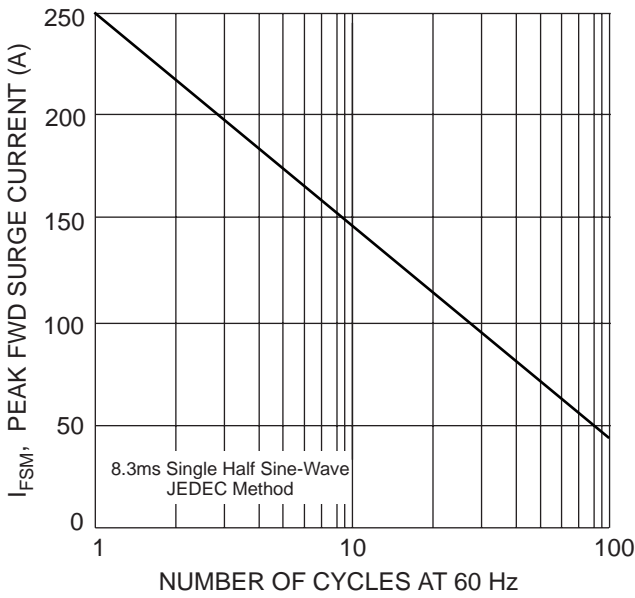

Fig. 3 Max Non-Repetitive Peak Fwd Surge Current

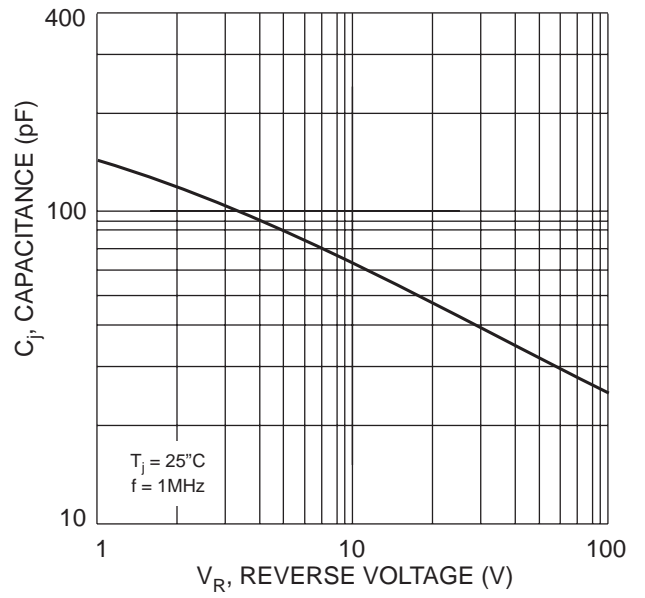

Fig. 4 Typical Junction Capacitance Per Element

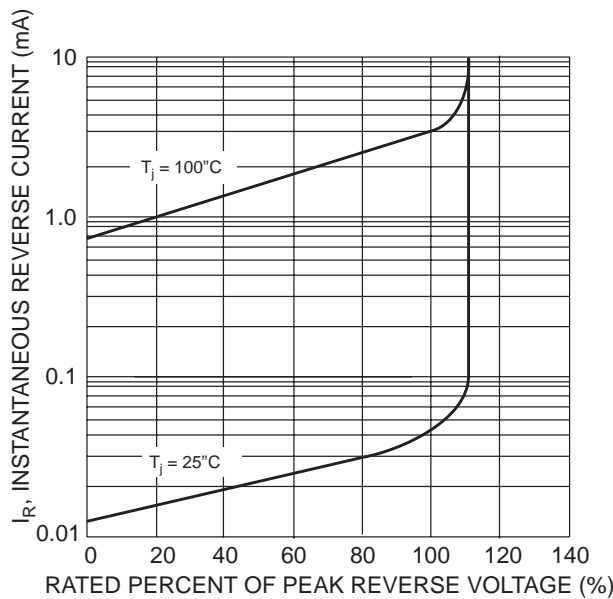
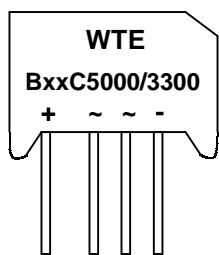

Fig. 5 Typical Reverse Characteristics

MARKING INFORMATION



WTE = Manufacturer's Logo
 BxxC5000/3300 = Device Number
 xx = 40, 80, 125, 250, 380, 500
 Polarity = As Marked on Body

PACKAGING INFORMATION

BULK

Inner Box Size L x W x H (mm)	Quantity (PCS)	Carton Size L x W x H (mm)	Quantity (PCS)	Approx. Gross Weight (KG)
230 x 230 x 56	200	500 x 255 x 275	2,000	23.0

Note: 1. Paper box, white or brown color.

ORDERING INFORMATION

Product No.	Package Type	Shipping Quantity
B40C5000/3300	SIL Bridge	200 Units/Box
B80C5000/3300	SIL Bridge	200 Units/Box
B125C5000/3300	SIL Bridge	200 Units/Box
B250C5000/3300	SIL Bridge	200 Units/Box
B380C5000/3300	SIL Bridge	200 Units/Box
B500C5000/3300	SIL Bridge	200 Units/Box

1. Shipping quantity given is for minimum packing quantity only. For minimum order quantity, please consult the Sales Department.
2. **To order Lead Free version (with Lead Free finish), add "-LF" suffix to part number above. For example, B40C5000/3300-LF.**

Won-Top Electronics Co., Ltd (WTE) has checked all information carefully and believes it to be correct and accurate. However, WTE cannot assume any responsibility for inaccuracies. Furthermore, this information does not give the purchaser of semiconductor devices any license under patent rights to manufacturer. WTE reserves the right to change any or all information herein without further notice.

WARNING: DO NOT USE IN LIFE SUPPORT EQUIPMENT. WTE power semiconductor products are not authorized for use as critical components in life support devices or systems without the express written approval.

Won-Top Electronics Co., Ltd.

No. 44 Yu Kang North 3rd Road, Chine Chen Dist., Kaohsiung, Taiwan

Phone: 886-7-822-5408 or 886-7-822-5410

Fax: 886-7-822-5417

Email: sales@wontop.com

Internet: <http://www.wontop.com>

We power your everyday.