



Aluminum electrolytic capacitors

SMD capacitors

Series/Type: B41145
Date: November 2008

SMD
General-purpose grade capacitors
Applications

- Low impedance applications

Features

- Low impedance
- RoHS compatible
- Load life of 1000 h at 105 °C
- Wide temperature range (–55 °C ... +105 °C)

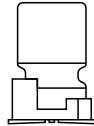
Construction

- Surface mounting device
- Minus pole marking on the case

Delivery mode

- Taped and reeled
Refer to chapter "SMD capacitors - Taping and packing" for further details.

Specifications and characteristics in brief

Rated voltage V_R	6.3 ... 50 V DC						
Operating temperature range	–55 °C ... +105 °C						
Rated capacitance C_R (20 °C, 120 Hz)	1.0 ... 1500 μ F						
Capacitance tolerance	$\pm 20\% \triangleq M$						
Load life (105 °C, V_R)	1000 h	Requirements: $\Delta C/C \leq \pm 20\%$ of initial value $\tan \delta \leq 2$ times initial specified limit $I_{leak} \leq$ initial specified limit					
Leakage current I_{leak} (20 °C, after 2 minutes)	$I_{leak} \leq 0.01 \mu A \cdot \left(\frac{C_R}{\mu F} \cdot \frac{V_R}{V} \right)$ or 3 μA , whichever is greater						
Low temperature stability (impedance ratio) (120 Hz)	V_R (V DC)	6.3	10	16	25	35	50
	$Z(-25\text{ °C})$	2	2	2	2	2	
	$Z(+20\text{ °C})$						
	$Z(-40\text{ °C})$	3	3	3	3	3	
	$Z(+20\text{ °C})$						
Shelf life	After storage for 1000 h at 105 °C, the capacitors shall meet the requirement of load life test after reforming process. After test: V_R to be applied for 30 minutes, 24 to 48 hours before measurement.						
Frequency multiplier for rated ripple current	50 Hz	120 Hz	300 Hz	1 kHz	≥ 10 kHz		
	0.35	0.50	0.64	0.83	1.00		

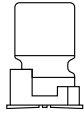
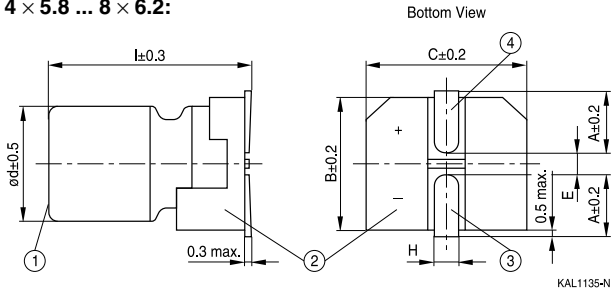
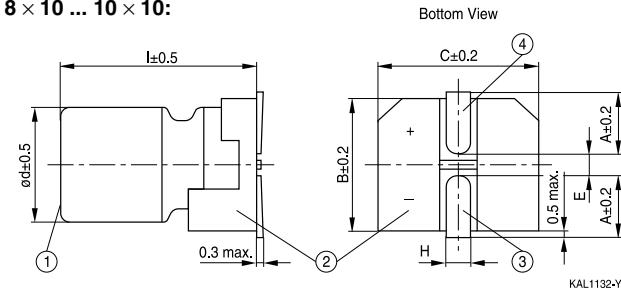
Dimensional drawings
d x l (mm)
4 × 5.8 ... 8 × 6.2:

d x l (mm)
8 × 10 ... 10 × 10:

①	Case
②	Terminal base board
③	Minus pole
④	Plus pole

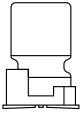
Case dimensions d x l (mm)	4 × 5.8	5 × 5.8	6.3 × 5.8	6.3 × 7.7	8 × 6.2	8 × 10	10 × 10
A	1.8	2.1	2.4	2.4	3.3	2.9	3.2
B	4.3	5.3	6.6	6.6	8.3	8.3	10.3
C	4.3	5.3	6.6	6.6	8.3	8.3	10.3
E	1.0	1.3	2.2	2.2	2.3	3.1	4.5
L	5.8	5.8	5.8	7.7	6.2	10	10
H	0.5 ... 0.8					0.8 ... 1.1	



B41145

Low impedance series – 105 °C

SMD

Layout recommendation

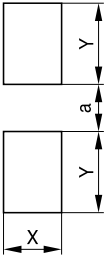

KAL1109-Z

d × l (mm)	X	Y	a
4.0 × 5.8	1.6	2.6	1.0
5.0 × 5.8	1.6	3.0	1.4
6.3 × 5.8	1.6	3.5	2.1
6.3 × 7.7	1.6	3.5	2.1
8.0 × 6.2	2.5	4.0	2.1
8.0 × 10.0	2.5	3.5	3.0
10.0 × 10.0	2.5	4.0	4.0

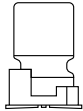

Overview of available types

V_R (V DC)	6.3	10	16	25	35	50
	Case dimensions $d \times l$ (mm)					
C_R (μ F)						
1.0					4 × 5.8	4 × 5.8
1.5					4 × 5.8	4 × 5.8
2.2					4 × 5.8	4 × 5.8
3.3					4 × 5.8	4 × 5.8
4.7				4 × 5.8	4 × 5.8	5 × 5.8
6.8				4 × 5.8	5 × 5.8	
10			4 × 5.8	5 × 5.8	5 × 5.8	6.3 × 5.8
15			5 × 5.8	6.3 × 5.8	6.3 × 5.8	
22	4 × 5.8	5 × 5.8	5 × 5.8	6.3 × 5.8	6.3 × 5.8	6.3 × 7.7
33	5 × 5.8	5 × 5.8	6.3 × 5.8	6.3 × 5.8	6.3 × 7.7	8 × 10
47	5 × 5.8	6.3 × 5.8	6.3 × 5.8	6.3 × 7.7	6.3 × 7.7	10 × 10
68	6.3 × 5.8	6.3 × 5.8	6.3 × 7.7	8 × 10		
100	6.3 × 5.8	6.3 × 7.7	6.3 × 7.7	8 × 10	8 × 10 10 × 10	10 × 10
150	6.3 × 7.7	6.3 × 7.7				
220	6.3 × 7.7	8 × 10	8 × 10 10 × 10	8 × 10 10 × 10	8 × 10 10 × 10	10 × 10
330	8 × 10		10 × 10	10 × 10	10 × 10	
470		10 × 10	10 × 10	10 × 10		
680			10 × 10			
1000	10 × 10	10 × 10				
1500	10 × 10					

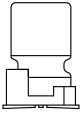
Other voltage and capacitance ratings are available upon request.

B41145
Low impedance series – 105 °C
SMD
Technical data and ordering codes

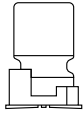
V_R	C_R 120 Hz 20 °C V DC μF	Case dimensions $d \times l$ mm	Z_{max} 100 kHz 20 °C Ω	$\tan \delta_{\text{max}}$ 120 Hz 20 °C	$I_{\text{AC,R}}$ 100 kHz 105 °C mA	Ordering code
6.3	22	4 × 5.8	3.0	0.26	60	B41145A2226M000
	33	5 × 5.8	1.8	0.26	95	B41145A2336M000
	47	5 × 5.8	1.8	0.26	95	B41145A2476M000
	68	6.3 × 5.8	1.0	0.26	140	B41145A2686M000
	100	6.3 × 5.8	1.0	0.26	140	B41145A2107M000
	150	6.3 × 7.7	0.6	0.26	230	B41145A2157M000
	220	6.3 × 7.7	0.6	0.26	230	B41145A2227M000
	330	8 × 10	0.3	0.26	450	B41145A2337M000
	1000	10 × 10	0.15	0.26	670	B41145A2108M000
	1500	10 × 10	0.15	0.26	670	B41145A2158M000
10	22	5 × 5.8	1.8	0.19	95	B41145A3226M000
	33	5 × 5.8	1.8	0.19	95	B41145A3336M000
	47	6.3 × 5.8	1.0	0.19	140	B41145A3476M000
	68	6.3 × 5.8	1.0	0.19	140	B41145A3686M000
	100	6.3 × 7.7	0.6	0.19	230	B41145A3107M000
	150	6.3 × 7.7	0.6	0.19	230	B41145A3157M000
	220	8 × 10	0.3	0.19	450	B41145A3227M000
	470	10 × 10	0.15	0.19	670	B41145A3477M000
	1000	10 × 10	0.15	0.19	670	B41145A3108M000
16	10	4 × 5.8	3.0	0.16	60	B41145A4106M000
	15	5 × 5.8	1.8	0.16	95	B41145A4156M000
	22	5 × 5.8	1.8	0.16	95	B41145A4226M000
	33	6.3 × 5.8	1.0	0.16	140	B41145A4336M000
	47	6.3 × 5.8	1.0	0.16	140	B41145A4476M000
	68	6.3 × 7.7	0.6	0.16	230	B41145A4686M000
	100	6.3 × 7.7	0.6	0.16	230	B41145A4107M000
	220	8 × 10	0.3	0.16	450	B41145A4227M000
	220	10 × 10	0.15	0.16	670	B41145B4227M000
	330	10 × 10	0.15	0.16	670	B41145A4337M000
	470	10 × 10	0.15	0.16	670	B41145A4477M000
	680	10 × 10	0.15	0.16	670	B41145A4687M000

Technical data and ordering codes

V_R	C_R 120 Hz 20 °C V DC μF	Case dimensions $d \times l$ mm	Z_{max} 100 kHz 20 °C Ω	$\tan \delta_{\text{max}}$ 120 Hz 20 °C	$I_{\text{AC,R}}$ 100 kHz 105 °C mA	Ordering code
25	4.7	4 × 5.8	3.0	0.14	60	B41145A5475M000
	6.8	4 × 5.8	3.0	0.14	60	B41145A5685M000
	10	5 × 5.8	1.8	0.14	95	B41145A5106M000
	15	6.3 × 5.8	1.0	0.14	140	B41145A5156M000
	22	6.3 × 5.8	1.0	0.14	140	B41145A5226M000
	33	6.3 × 5.8	1.0	0.14	140	B41145A5336M000
	47	6.3 × 7.7	0.6	0.14	230	B41145A5476M000
	68	8 × 10	0.3	0.14	450	B41145A5686M000
	100	8 × 10	0.3	0.14	450	B41145A5107M000
	220	8 × 10	0.3	0.14	450	B41145A5227M000
	220	10 × 10	0.15	0.14	670	B41145B5227M000
	330	10 × 10	0.15	0.14	670	B41145A5337M000
	470	10 × 10	0.15	0.14	670	B41145A5477M000
35	1	4 × 5.8	3.0	0.12	60	B41145A7105M000
	1.5	4 × 5.8	3.0	0.12	60	B41145A7155M000
	2.2	4 × 5.8	3.0	0.12	60	B41145A7225M000
	3.3	4 × 5.8	3.0	0.12	60	B41145A7335M000
	4.7	4 × 5.8	3.0	0.12	60	B41145A7475M000
	6.8	5 × 5.8	1.8	0.12	95	B41145A7685M000
	10	5 × 5.8	1.8	0.12	95	B41145A7106M000
	15	6.3 × 5.8	1.0	0.12	140	B41145A7156M000
	22	6.3 × 5.8	1.0	0.12	140	B41145A7226M000
	33	6.3 × 7.7	0.6	0.12	230	B41145A7336M000
	47	6.3 × 7.7	0.6	0.12	230	B41145A7476M000
	100	8 × 10	0.3	0.12	450	B41145A7107M000
	100	10 × 10	0.15	0.12	670	B41145B7107M000
	220	8 × 10	0.3	0.12	450	B41145A7227M000
	220	10 × 10	0.15	0.12	670	B41145B7227M000
	330	10 × 10	0.15	0.12	670	B41145A7337M000

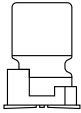
B41145
Low impedance series – 105 °C
SMD
Technical data and ordering codes

V_R	C_R 120 Hz 20 °C μF	Case dimensions $d \times l$ mm	Z_{max} 100 kHz 20 °C Ω	$\tan \delta_{\text{max}}$ 120 Hz 20 °C	$I_{\text{AC,R}}$ 100 kHz 105 °C mA	Ordering code
50	1	4 × 5.8	5.0	0.12	30	B41145A6105M000
	1.5	4 × 5.8	5.0	0.12	30	B41145A6155M000
	2.2	4 × 5.8	5.0	0.12	30	B41145A6225M000
	3.3	4 × 5.8	5.0	0.12	30	B41145A6335M000
	4.7	5 × 5.8	3.0	0.12	50	B41145A6475M000
	10	6.3 × 5.8	2.0	0.12	80	B41145A6106M000
	22	6.3 × 7.7	1.0	0.12	120	B41145A6226M000
	33	8 × 10	0.6	0.12	300	B41145A6336M000
	47	10 × 10	0.3	0.12	500	B41145A6476M000
	100	10 × 10	0.3	0.12	500	B41145A6107M000
	220	10 × 10	0.3	0.12	500	B41145A6227M000

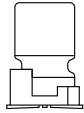

Mounting instructions

Soldering

Recommended conditions for series B41115, B41123 and B41145

For reflow, use thermal conduction systems such as infrared radiation (IR) or hot blast. Vapor heat transfer systems (VPS) are not recommended.

- Observe proper soldering conditions (temperature, time, etc.).
- Do not exceed the specified limits.
- Temperature measuring method: Measure temperature in assuming quantitative production, by sticking the thermo-couple to the capacitor upper part with epoxy adhesives.
- Consult us for additional reflow restrictions.

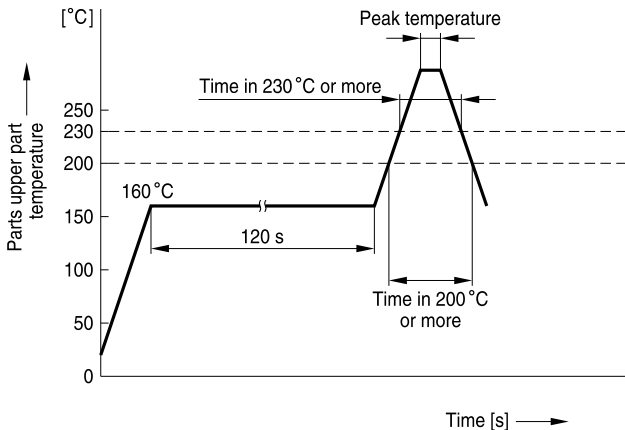

KAL1133-7-E

d (mm)	4 ... 6.3	8 ... 10
Peak temperature	260 °C (255 °C)	245 °C
Time in peak temperature	5 s in 250 °C or more (10 s in 250 °C or more)	10 s in 240 °C or more
Time in 230 °C or more	30 s	30 s
Time in 200 °C or more	70 s	70 s
Time of reflow	2 times	2 times

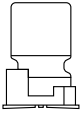

B41145

Low impedance series – 105 °C

SMD

Taping and packing

Taping of SMD capacitors

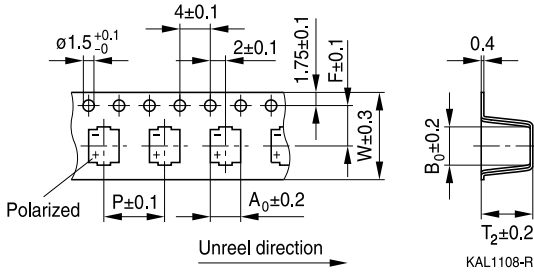

Case dimensions $d \times l$ (mm)	4 × 5.4	4 × 5.8	5 × 5.4	5 × 5.8	6.3 × 5.4
W	12.0	12.0	12.0	12.0	16.0
P	8.0	8.0	12.0	12.0	12.0
F	5.5	5.5	5.5	5.5	7.5
A_0	5.0	5.0	6.0	6.0	7.0
B_0	5.0	5.0	6.0	6.0	7.0
T_2	5.8	6.3	5.8	6.3	5.8

Case dimensions $d \times l$ (mm)	6.3 × 5.8	6.3 × 7.7	8 × 6.2	8 × 10	10 × 10
W	16.0	16.0	16.0	24.0	24.0
P	12.0	12.0	12.0	16.0	16.0
F	7.5	7.5	7.5	11.5	11.5
A_0	7.0	7.0	8.7	8.7	10.7
B_0	7.0	7.0	8.7	8.7	10.7
T_2	6.3	8.2	6.8	11.0	11.0

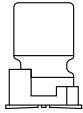

Reel packing

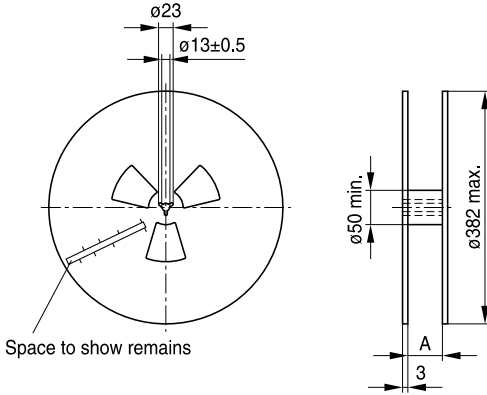

KAL1110-3

Capacitor dimensions d × l (mm)	Quantity per reel pcs.
4 × l	2000 pcs.
5 × l, 6.3 × l, 8 × 6.2	1000 pcs.
8 × 10, 10 × l	500 pcs.

d × l (mm)	4 × l, 5 × l	6.3 × l, 8 × 6.2	8 × 10, 10 × l
A	14	18	26

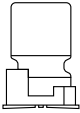

B41145

Low impedance series – 105 °C

SMD

Cautions and warnings

General

- 1 Aluminum electrolytic capacitors have a bi-polar structure. This is marked on the body of the capacitor. A capacitor must not be mounted with reversed polarity. The application of an AC or reverse voltage may cause a short circuit or damage the capacitor. Bi-polar capacitors must not be used in AC applications, where the polarity may be reversed in the circuits or is unknown.
- 2 The DC voltage applied to the capacitor terminal must not exceed its rated operating voltage, as this will result in a rapid increase of the leakage current and may damage the capacitor. It is recommended to operate the capacitor at 70 – 80% of its rated voltage to optimize its service life.
- 3 The ripple current applied to the capacitor must be within the permitted range. An excessive ripple current leads to impaired electrical properties and may damage the capacitor. Note that the sum of the peak values of the ripple voltage and the DC operating voltage must not exceed the rated DC voltage.
- 4 Capacitors must be used within their permitted range of operating temperature. Operation at room temperature optimizes their service life.
- 5 Capacitors with case diameter ≥ 8 mm are equipped with a safety vent. In capacitors fitted with a lead or soldering lug, the safety vent is usually located at the base of the case. It needs sufficient space around it to operate optimally. The following dimensions are recommended: for case diameter $d = 8$ to 16 mm, more than 2 mm; for $d = 18$ to 35 mm, more than 3 mm; and for $d = 42$ mm or more, more than 5 mm.
- 6 Capacitors should not be mounted with the safety vent face down on the board. Do not locate any wire or copper trace near the safety vent. Do not reverse the voltage, as this may result in excess pressure and the leakage of electrolyte.
- 7 Gas is released through the safety vent when the pressure inside the capacitor is too high. A gaseous liquid around the safety vent does not indicate a leakage of electrolyte.
- 8 The capacitor should be stored under conditions of normal temperature and in a non-acid, non-alkali environment of normal humidity. Exposure to high temperatures, for example under direct sunlight, will reduce its operating life. If the capacitor is stored in an environment containing acids or alkalis, the solderability of the leads may be affected.
- 9 containing acids or alkalis, the solderability of the leads may be affected. The leakage current of an aluminum electrolytic capacitor may increase after a long period of storage. After such storage, the capacitor must be aged by applying the rated operating voltage for 6 – 8 hours before use.
- 10 Manual soldering:
 - a Soldering must be performed within the specified conditions.
Bit temperature: 350 °C; application time of soldering iron: 3 seconds.
 - b Ensure that the soldering iron does not touch any part of the capacitor body.

SMD

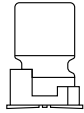

- 11 Do not apply excessive force to the leads and terminals. Do not move the capacitor after soldering it onto the PC board and do not carry the PC board by gripping the capacitor. Observe the following rules to prevent undue stress to the capacitor:
 - a Do not tilt or bend the capacitor after soldering.
 - b Ensure that the terminal spacing matches the corresponding hole spacing on the PC board.
- 12 The aluminum case is not insulated from the cathode. Do not place a conductor under the aluminum capacitors on the PC board as this may cause a short circuit. The case and top of capacitors used in switched mode power supplies have a high-voltage-resistant heat shrink sleeve to ensure safe usage.
- 13 The leads of capacitors with a case diameter exceeding 14 mm cannot be used for fixing.

Important notes

The following applies to all products named in this publication:

1. Some parts of this publication contain **statements about the suitability of our products for certain areas of application**. These statements are based on our knowledge of typical requirements that are often placed on our products in the areas of application concerned. We nevertheless expressly point out **that such statements cannot be regarded as binding statements about the suitability of our products for a particular customer application**. As a rule, EPCOS is either unfamiliar with individual customer applications or less familiar with them than the customers themselves. For these reasons, it is always ultimately incumbent on the customer to check and decide whether an EPCOS product with the properties described in the product specification is suitable for use in a particular customer application.
2. We also point out that **in individual cases, a malfunction of electronic components or failure before the end of their usual service life cannot be completely ruled out in the current state of the art, even if they are operated as specified**. In customer applications requiring a very high level of operational safety and especially in customer applications in which the malfunction or failure of an electronic component could endanger human life or health (e.g. in accident prevention or lifesaving systems), it must therefore be ensured by means of suitable design of the customer application or other action taken by the customer (e.g. installation of protective circuitry or redundancy) that no injury or damage is sustained by third parties in the event of malfunction or failure of an electronic component.
3. **The warnings, cautions and product-specific notes must be observed.**
4. In order to satisfy certain technical requirements, **some of the products described in this publication may contain substances subject to restrictions in certain jurisdictions (e.g. because they are classed as hazardous)**. Useful information on this will be found in our Material Data Sheets on the Internet (www.epcos.com/material). Should you have any more detailed questions, please contact our sales offices.
5. We constantly strive to improve our products. Consequently, **the products described in this publication may change from time to time**. The same is true of the corresponding product specifications. Please check therefore to what extent product descriptions and specifications contained in this publication are still applicable before or when you place an order. We also **reserve the right to discontinue production and delivery of products**. Consequently, we cannot guarantee that all products named in this publication will always be available. The aforementioned does not apply in the case of individual agreements deviating from the foregoing for customer-specific products.
6. Unless otherwise agreed in individual contracts, **all orders are subject to the current version of the "General Terms of Delivery for Products and Services in the Electrical Industry" published by the German Electrical and Electronics Industry Association (ZVEI)**.
7. The trade names EPCOS, BAOKE, Alu-X, CeraDiode, CSSP, CTVS, DSSP, MiniBlue, MKK, MLSC, MotorCap, PCC, PhaseCap, PhaseMod, SIFERRIT, SIFI, SIKOREL, SilverCap, SIMDAD, SIMID, SineFormer, SIOV, SIP5D, SIP5K, ThermoFuse, WindCap are **trademarks registered or pending** in Europe and in other countries. Further information will be found on the Internet at www.epcos.com/trademarks.