



Aluminum electrolytic capacitors

Capacitors with screw terminals

Series/Type: B41550, B41570

Date: November 2008

Long-life grade capacitors

Applications

- Highly professional power supplies

Features

- Outstanding reliability
- Operation at temperatures up to 125 °C permissible without insulating sleeve¹⁾
- High ripple current capability
- Long useful life
- Shelf life up to 10 years
- All-welded construction ensures reliable electrical contact
- RoHS-compatible

Construction

- Charge-discharge proof, polar
- Aluminum case with insulating sleeve
- Poles with screw terminal connections
- Mounting with ring clips, clamps or threaded stud
- The bases of types with threaded stud are not insulated



B41550

B41570

1) For $\varnothing \leq 51.6$ mm: 2500 h, for $\varnothing \geq 64.3$ mm: 5000 h



Specifications and characteristics in brief

Rated voltage V_R	16 ... 100 V DC	
Surge voltage V_S	$1.15 \cdot V_R$	
Rated capacitance C_R	1500 ... 220000 μ F	
Capacitance tolerance	-10/+30% \triangle Q	
Leakage current I_{leak} (20 °C, 5 min)	$I_{leak} \leq 0.3 \mu A \cdot \left(\frac{C_R}{\mu F} \cdot \frac{V_R}{V} \right)^{0.7} + 4 \mu A$	
Self-inductance ESL	d = 35.7 mm: approx. 10 nH d = 51.6 mm: approx. 15 nH d \geq 64.3 mm: approx. 20 nH	
Useful life	d \leq 51.6 mm d \geq 64.3 mm	Requirements:
105 °C; V_R ; $I_{AC,R}$	> 10000 h > 20000 h	$\Delta C/C$ $\leq \pm 45\%$ of initial value
85 °C; V_R ; $I_{AC,max}$	> 15000 h > 25000 h	ESR ≤ 3 times initial specified limit
40 °C; V_R ; $2.4 \cdot I_{AC,R}$	> 200000 h –	I_{leak} \leq initial specified limit
40 °C; V_R ; $2.7 \cdot I_{AC,R}$	– > 200000 h	
Voltage endurance test		Post test requirements:
105 °C; V_R ; $I_{AC,R}$	5000 h	$\Delta C/C$ $\leq \pm 15\%$ of initial value
		ESR ≤ 1.3 times initial specified limit
		I_{leak} \leq initial specified limit
Vibration resistance test	To IEC 60068-2-6, test Fc: Displacement amplitude 0.75 mm, frequency range 10 ... 55 Hz, acceleration max. 10 g, duration 3 \times 2 h. Capacitor mounted by its body which is rigidly clamped to the work surface.	
IEC climatic category	To IEC 60068-1: 55/105/56 (-55 °C/+105 °C/56 days damp heat test)	
Detail specification	Similar to CECC 30301-804	
Sectional specification	IEC 60384-4	

Ripple current capability

Due to the ripple current capability of the contact elements, the following current upper limits must not be exceeded:

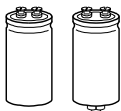
Capacitor diameter	≤ 51.6 mm	> 51.6 mm
$I_{AC,max}$	30 A	40 A



B41550, B41570

SIKOREL – 105 °C

Dimensional drawings

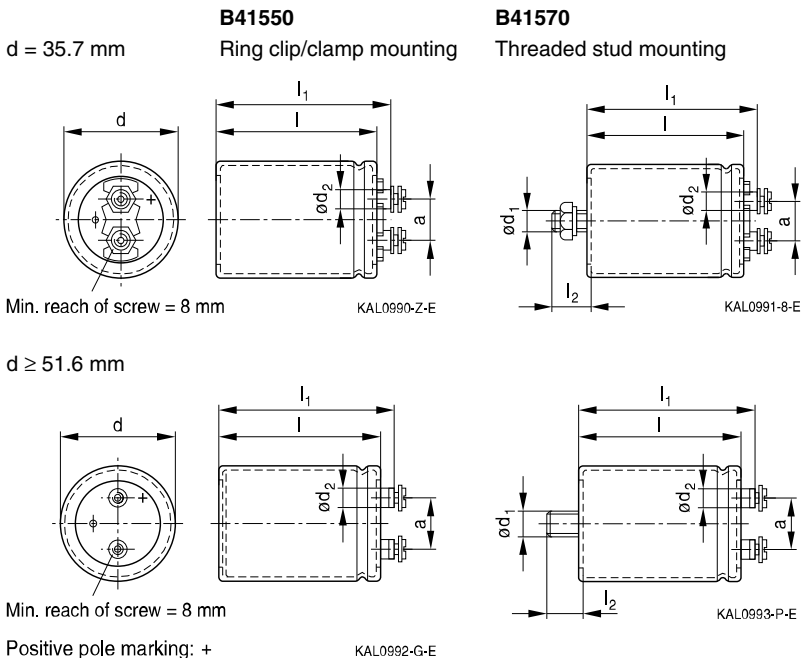

Dimensions and weights

Ter- minal	Dimensions (mm) with insulating sleeve							Approx. weight (g)
	d	$l \pm 1$	$l_1 \pm 1$	$l_2 +0/-1$	d_1	$d_2 \text{ max.}$	$a +0.2/-0.4$	
M5	35.7 +0/-0.8	55.7	62.0	13	M8	8.2	12.7	65
M5	35.7 +0/-0.8	80.7	87.0	13	M8	8.2	12.7	105
M5	35.7 +0/-0.8	105.7	112.0	13	M8	8.2	12.7	135
M5	51.6 +0/-0.8	80.7	87.0	17	M12	8.2	22.2	220
M5	64.3 +0/-0.8	80.7	87.0	17	M12	8.2	28.5	370
M5	64.3 +0/-0.8	105.7	112.0	17	M12	8.2	28.5	440
M5	76.9 +0/-0.7	105.7	112.0	17	M12	8.2	31.7	620
M5	76.9 +0/-0.7	143.2	149.5	17	M12	8.2	31.7	840

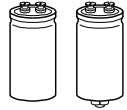

Packing

Capacitor diameter d (mm)	length l (mm)	Packing units (pcs.)
35.7	all	36
51.6	all	36
64.3	all	25

Capacitor diameter d (mm)	length l (mm)	Packing units (pcs.)
76.9	97.0 - 168.7	16
	191.0 - 220.7	12



For ecological reasons the packing is pure cardboard.

Accessories

The following items are included in the delivery package, but are not fastened to the capacitors:

	Thread	Toothed washers	Screws/nuts	Maximum torque
For terminals	M5	A 5.1 DIN 6797	Cylinder-head screw M5 × 8 DIN 84-4.8	2 Nm
For mounting	M8	J 8.2 DIN 6797	Hex nut BM 8 DIN 439	4 Nm
	M12	J 12.5 DIN 6797	Hex nut BM 12 DIN 439	10 Nm

The following items must be ordered separately. For details, refer to chapter "Capacitors with screw terminals – Accessories".

Item	Type
Ring clips	B44030
Clamps for capacitors with $d \geq 64.3$ mm	B44030
Insulating parts	B44020

B41550, B41570
SIKOREL – 105 °C
Overview of available types

V_R (V DC)	16	25	40	63	100
	Case dimensions $d \times l$ (mm)				
C_R (μ F)					
1500					35.7 × 55.7
2200				35.7 × 55.7	35.7 × 80.7
3300				35.7 × 80.7	35.7 × 105.7
4700			35.7 × 55.7	35.7 × 80.7	51.6 × 80.7
6800		35.7 × 55.7	35.7 × 80.7	35.7 × 105.7	64.3 × 80.7
10000	35.7 × 55.7	35.7 × 80.7	35.7 × 80.7	51.6 × 80.7	64.3 × 80.7
15000	35.7 × 80.7	35.7 × 80.7	35.7 × 105.7	64.3 × 80.7	64.3 × 105.7
22000	35.7 × 80.7	35.7 × 105.7	51.6 × 80.7	64.3 × 105.7	76.9 × 105.7
33000	35.7 × 105.7	51.6 × 80.7	64.3 × 80.7	76.9 × 105.7	76.9 × 143.2
47000	51.6 × 80.7	64.3 × 80.7	64.3 × 105.7	76.9 × 143.2	
68000	64.3 × 80.7	64.3 × 105.7	76.9 × 105.7		
100000	64.3 × 105.7	76.9 × 105.7	76.9 × 143.2		
150000	76.9 × 105.7	76.9 × 143.2			
220000	76.9 × 143.2				

The capacitance and voltage ratings listed above are available in different cases upon request.

Other voltage and capacitance ratings are also available upon request.

Technical data and ordering codes

C_R 100 Hz 20 °C μF	Case dimensions $d \times l$ mm	ESR_{typ} 100 Hz 20 °C $\text{m}\Omega$	ESR_{max} 100 Hz 20 °C $\text{m}\Omega$	Z_{max} 10 kHz 20 °C $\text{m}\Omega$	$I_{\text{AC,max}}$ 100 Hz 40 °C A	$I_{\text{AC,max}}$ 100 Hz 85 °C A	$I_{\text{AC,R}}$ 100 Hz 105 °C A	Ordering code (composition see below)
$V_R = 16 \text{ V DC}$								
10000	35.7 × 55.7	15	38	26	17	12	6.2	B415*0E4109Q000
15000	35.7 × 80.7	12	26	21	23	16	8.1	B415*0E4159Q000
22000	35.7 × 80.7	9.0	21	18	29	21	10	B415*0E4229Q000
33000	35.7 × 105.7	7.0	17	13	30	24	12	B415*0E4339Q000
47000	51.6 × 80.7	5.0	13	13	30	30	16	B415*0E4479Q000
68000	64.3 × 80.7	5.0	13	13	40	38	17	B415*0E4689Q000
100000	64.3 × 105.7	4.0	10	9.0	40	39	19	B415*0E4100Q000
150000	76.9 × 105.7	4.0	10	10	40	40	22	B415*0E4150Q000
220000	76.9 × 143.2	4.0	8.0	7.0	40	40	26	B415*0A4220Q000
$V_R = 25 \text{ V DC}$								
6800	35.7 × 55.7	16	32	27	18	13	6.4	B415*0A5688Q000
10000	35.7 × 80.7	14	28	21	21	15	7.5	B415*0E5109Q000
15000	35.7 × 80.7	11	24	17	26	19	9.4	B415*0E5159Q000
22000	35.7 × 105.7	8.0	20	15	30	22	11	B415*0E5229Q000
33000	51.6 × 80.7	6.0	13	12	30	29	15	B415*0E5339Q000
47000	64.3 × 80.7	5.0	13	11	40	34	17	B415*0E5479Q000
68000	64.3 × 105.7	5.0	11	9.0	40	35	17	B415*0E5689Q000
100000	76.9 × 105.7	4.0	9.0	8.0	40	39	21	B415*0E5100Q000
150000	76.9 × 143.2	4.0	7.0	6.0	40	40	26	B415*0A5150Q000
$V_R = 40 \text{ V DC}$								
4700	35.7 × 55.7	14	33	24	20	14	7.2	B415*0E7478Q000
6800	35.7 × 80.7	12	28	17	24	16	8.4	B415*0A7688Q000
10000	35.7 × 80.7	11	27	14	26	19	9.4	B415*0E7109Q000
15000	35.7 × 105.7	8.0	15	15	30	22	11	B415*0E7159Q000
22000	51.6 × 80.7	6.0	13	13	30	29	15	B415*0E7229Q000
33000	64.3 × 80.7	5.0	12	12	40	34	17	B415*0E7339Q000
47000	64.3 × 105.7	5.0	8.0	8.0	40	35	17	B415*0E7479Q000
68000	76.9 × 105.7	4.0	9.0	7.0	40	39	21	B415*0E7689Q000
100000	76.9 × 143.2	4.0	7.0	6.0	40	40	26	B415*0A7100Q000

Composition of ordering code

* = Mounting style

5 = for capacitors with ring clip/clamp mounting

7 = for capacitors with threaded stud

B41550, B41570
SIKOREL – 105 °C
Technical data and ordering codes

C_R 100 Hz 20 °C μF	Case dimensions $d \times l$ mm	ESR_{typ} 100 Hz 20 °C mΩ	ESR_{max} 100 Hz 20 °C mΩ	Z_{max} 10 kHz 20 °C mΩ	$I_{AC,max}$ 100 Hz 40 °C A	$I_{AC,max}$ 100 Hz 85 °C A	$I_{AC,R}$ 100 Hz 105 °C A	Ordering code (composition see below)
$V_R = 63 \text{ V DC}$								
2200	35.7 × 55.7	26	60	30	13	9.4	4.7	B415*0E8228Q000
3300	35.7 × 80.7	17	39	24	19	14	6.8	B415*0E8338Q000
4700	35.7 × 80.7	13	31	20	24	17	8.7	B415*0E8478Q000
6800	35.7 × 105.7	10	23	17	28	20	10	B415*0E8688Q000
10000	51.6 × 80.7	7.0	18	14	30	27	13	B415*0E8109Q000
15000	64.3 × 80.7	6.0	13	11	40	31	15	B415*0E8159Q000
22000	64.3 × 105.7	5.0	10	9.0	40	35	17	B415*0E8229Q000
33000	76.9 × 105.7	4.0	8.0	8.0	40	39	21	B415*0E8339Q000
47000	76.9 × 143.2	3.0	7.0	6.0	40	40	26	B415*0A8479Q000
$V_R = 100 \text{ V DC}$								
1500	35.7 × 55.7	36	83	34	12	8.8	4.2	B415*0A9158Q000
2200	35.7 × 80.7	26	57	30	16	12	5.9	B415*0E9228Q000
3300	35.7 × 105.7	17	37	24	22	16	8.0	B415*0E9338Q000
4700	51.6 × 80.7	15	29	20	28	20	10	B415*0E9478Q000
6800	64.3 × 80.7	10	20	17	36	26	13	B415*0E9688Q000
10000	64.3 × 80.7	8	15	14	40	32	16	B415*0E9109Q000
15000	64.3 × 105.7	7	13	11	40	36	18	B415*0E9159Q000
22000	76.9 × 105.7	6	11	9.0	40	38	19	B415*0A9229Q000
33000	76.9 × 143.2	5	9.0	8.0	40	40	23	B415*0A9339Q000

Composition of ordering code

* = Mounting style

5 = for capacitors with ring clip/clamp mounting

7 = for capacitors with threaded stud



Useful life

depending on ambient temperature T_A under ripple current operating conditions¹⁾

$d \leq 51.6$ mm

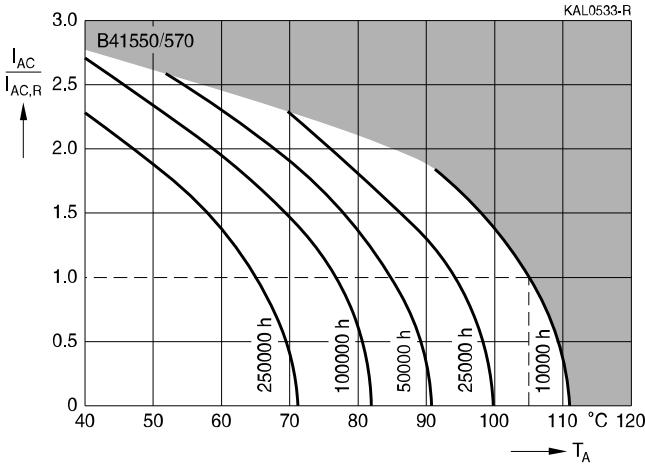

$d \geq 64.3$ mm

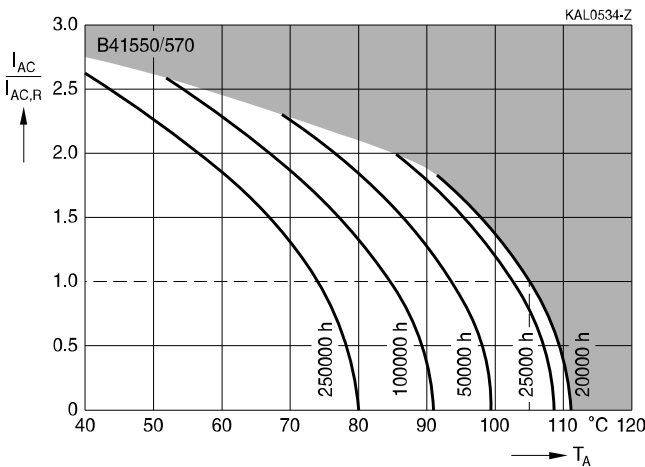

1) Refer to chapter "General technical information, 5.3 Calculation of useful life" on how to interpret the useful life graphs.



B41550, B41570

SIKOREL – 105 °C

Frequency factor of permissible ripple current I_{AC} versus frequency f

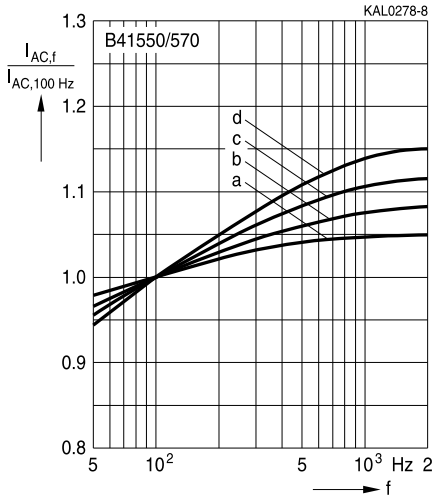

V_R (V DC)	16; 25	40	63	100
$d = 35.7$ mm	b	c	d	d
$d = 51.6$ mm	a	b	c	c
$d = 64.3$ mm	a	a	c	c
$d = 76.9$ mm	a	a	b	c

Frequency characteristics of ESR

Typical behavior

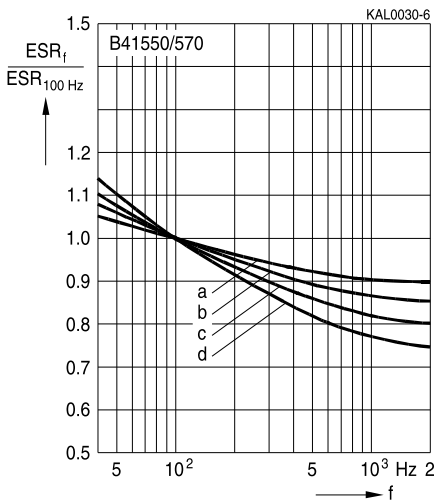

V_R (V DC)	16; 25	40	63	100
$d = 35.7$ mm	b	c	d	d
$d = 51.6$ mm	a	b	c	c
$d = 64.3$ mm	a	a	c	c
$d = 76.9$ mm	a	a	b	c



Impedance Z versus frequency f

Typical behavior at 20 °C

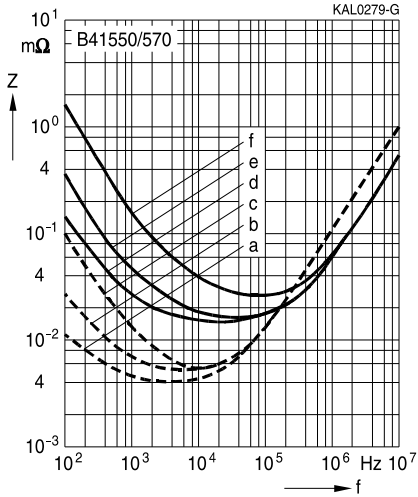

C_R μF	V_R V DC	d mm	Curve
150000	16	76.9	a
68000	40	76.9	b
15000	100	64.3	c
10000	16	35.7	d
47000	40	35.7	e
1500	100	35.7	f

**B41550, B41570****SIKOREL – 105 °C**

Cautions and warnings

Personal safety

The electrolytes used by EPCOS have not only been optimized with a view to the intended application, but also with regard to health and environmental compatibility. They do not contain any solvents that are detrimental to health, e.g. dimethyl formamide (DMF) or dimethyl acetamide (DMAC).

Furthermore, part of the high-voltage electrolytes used by EPCOS are self-extinguishing. They contain flame-retarding substances which will quickly extinguish any flame that may have been ignited.

As far as possible, EPCOS does not use any dangerous chemicals or compounds to produce operating electrolytes. However, in exceptional cases, such materials must be used in order to achieve specific physical and electrical properties because no safe substitute materials are currently known. However, the amount of dangerous materials used in our products has been limited to an absolute minimum. Nevertheless, the following rules should be observed when handling Al electrolytic capacitors:

- Any escaping electrolyte should not come into contact with eyes or skin.
- If electrolyte does come into contact with the skin, wash the affected parts immediately with running water. If the eyes are affected, rinse them for 10 minutes with plenty of water. If symptoms persist, seek medical treatment.
- Avoid breathing in electrolyte vapor or mists. Workplaces and other affected areas should be well ventilated. Clothing that has been contaminated by electrolyte must be changed and rinsed in water.



Product safety

The table below summarize the safety instructions that must be observed without fail. A detailed description can be found in the relevant sections of chapter "General technical information".

Topic	Safety information	Reference Chapter "General technical information"
Polarity	Make sure that polar capacitors are connected with the right polarity.	1 "Basic construction of aluminum electrolytic capacitors"
Reverse voltage	Voltages polarity classes should be prevented by connecting a diode.	3.1.6 "Reverse voltage"
Upper category temperature	Do not exceed the upper category temperatur.	7.2 "Maximum permissible operating temperature"
Maintenance	Make periodic inspections of the capacitors. Before the inspection, make sure that the power supply is turned off and carefully discharge the electricity of the capacitors. Do not apply any mechanical stress to the capacitor terminals.	10 "Maintenance"
Mounting position of screw terminal capacitors	Do not mount the capacitor with the terminals (safety vent) upside down.	11.1. "Mounting positions of capacitors with screw terminals"
Mounting of single-ended capacitors	The internal structure of single-ended capacitors might be damaged if excessive force is applied to the lead wires. Avoid any compressive, tensile or flexural stress. Do not move the capacitor after soldering to PC board. Do not pick up the PC board by the soldered capacitor. Do not insert the capacitor on the PC board with a hole space different to the lead space specified.	11.4 "Mounting considerations for single-ended capacitors"
Robustness of terminals	The following maximum tightening torques must not be exceeded when connecting screw terminals: M5: 2 Nm M6: 2.5 Nm	11.3 "Mounting torques"
Soldering	Do not exceed the specified time or temperature limits during soldering.	11.5 "Soldering"

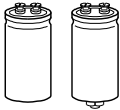

B41550, B41570

SIKOREL – 105 °C

Topic	Safety information	Reference Chapter "General technical information"
Soldering, cleaning agents	Do not allow halogenated hydrocarbons to come into contact with aluminum electrolytic capacitors.	11.6 "Cleaning agents"
Passive flammability	Avoid external energy, such as fire or electricity.	8.1 "Passive flammability"
Active flammability	Avoid overload of the capacitors.	8.2 "Active flammability"
		Reference Chapter "Capacitors with screw terminals"
Breakdown strength of insulating sleeves	Do not damage the insulating sleeve, especially when ring clips are used for mounting.	"Screw terminals - accessories"

Symbols and terms

Symbol	English	German
C	Capacitance	Kapazität
C_R	Rated capacitance	Nennkapazität
C_S	Series capacitance	Serienkapazität
$C_{S,T}$	Series capacitance at temperature T	Serienkapazität bei Temperatur T
C_f	Capacitance at frequency f	Kapazität bei Frequenz f
d	Case diameter, nominal dimension	Gehäusedurchmesser, Nennmaß
d_{max}	Maximum case diameter	Maximaler Gehäusedurchmesser
ESL	Self-inductance	Eigeninduktivität
ESR	Equivalent series resistance	Ersatzserienwiderstand
ESR_f	Equivalent series resistance at frequency f	Ersatzserienwiderstand bei Frequenz f
ESR_T	Equivalent series resistance at temperature T	Ersatzserienwiderstand bei Temperatur T
f	Frequency	Frequenz
I	Current	Strom
I_{AC}	Alternating current (ripple current)	Wechselstrom
$I_{AC,rms}$	Root-mean-square value of alternating current	Wechselstrom, Effektivwert
$I_{AC,f}$	Ripple current at frequency f	Wechselstrom bei Frequenz f
$I_{AC,max}$	Maximum permissible ripple current	Maximal zulässiger Wechselstrom
$I_{AC,R}$	Rated ripple current	Nennwechselstrom
$I_{AC,R} (B)$	Rated ripple current for base cooling	Nennwechselstromstrom für Bodenkühlung
I_{leak}	Leakage current	Ableitstrom
$I_{leak,op}$	Operating leakage current	Ableitstrom bei Betrieb
l	Case length, nominal dimension	Gehäuselänge, Nennmaß
l_{max}	Maximum case length (without terminals and mounting stud)	Maximale Gehäuselänge (ohne Anschlüsse und Gewindebolzen)
R	Resistance	Widerstand
R_{ins}	Insulation resistance	Isolationswiderstand
R_{symm}	Balancing resistance	Symmetrierwiderstand
T	Temperature	Temperatur
ΔT	Temperature difference	Temperaturdifferenz
T_A	Ambient temperature	Umgebungstemperatur
T_C	Case temperature	Gehäusetemperatur
T_B	Capacitor base temperature	Temperatur des Becherbodens
t	Time	Zeit
Δt	Period	Zeitraum
t_b	Service life (operating hours)	Brauchbarkeitsdauer (Betriebszeit)

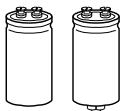
B41550, B41570
SIKOREL – 105 °C

Symbol	English	German
V	Voltage	Spannung
V _F	Forming voltage	Formierspannung
V _{op}	Operating voltage	Betriebsspannung
V _R	Rated voltage, DC voltage	Nennspannung, Gleichspannung
V _S	Surge voltage	Spitzenspannung
X _C	Capacitive reactance	Kapazitiver Blindwiderstand
X _L	Inductive reactance	Induktiver Blindwiderstand
Z	Impedance	Scheinwiderstand
Z _T	Impedance at temperature T	Scheinwiderstand bei Temperatur T
tan δ	Dissipation factor	Verlustfaktor
λ	Failure rate	Ausfallrate
ε ₀	Absolute permittivity	Elektrische Feldkonstante
ε _r	Relative permittivity	Dielektrizitätszahl
ω	Angular velocity; $2 \cdot \pi \cdot f$	Kreisfrequenz; $2 \cdot \pi \cdot f$

Notes

All dimensions are given in mm.

Important notes

The following applies to all products named in this publication:

1. Some parts of this publication contain **statements about the suitability of our products for certain areas of application**. These statements are based on our knowledge of typical requirements that are often placed on our products in the areas of application concerned. We nevertheless expressly point out **that such statements cannot be regarded as binding statements about the suitability of our products for a particular customer application**. As a rule, EPCOS is either unfamiliar with individual customer applications or less familiar with them than the customers themselves. For these reasons, it is always ultimately incumbent on the customer to check and decide whether an EPCOS product with the properties described in the product specification is suitable for use in a particular customer application.
2. We also point out that **in individual cases, a malfunction of electronic components or failure before the end of their usual service life cannot be completely ruled out in the current state of the art, even if they are operated as specified**. In customer applications requiring a very high level of operational safety and especially in customer applications in which the malfunction or failure of an electronic component could endanger human life or health (e.g. in accident prevention or lifesaving systems), it must therefore be ensured by means of suitable design of the customer application or other action taken by the customer (e.g. installation of protective circuitry or redundancy) that no injury or damage is sustained by third parties in the event of malfunction or failure of an electronic component.
3. **The warnings, cautions and product-specific notes must be observed.**
4. In order to satisfy certain technical requirements, **some of the products described in this publication may contain substances subject to restrictions in certain jurisdictions (e.g. because they are classed as hazardous)**. Useful information on this will be found in our Material Data Sheets on the Internet (www.epcos.com/material). Should you have any more detailed questions, please contact our sales offices.
5. We constantly strive to improve our products. Consequently, **the products described in this publication may change from time to time**. The same is true of the corresponding product specifications. Please check therefore to what extent product descriptions and specifications contained in this publication are still applicable before or when you place an order. We also **reserve the right to discontinue production and delivery of products**. Consequently, we cannot guarantee that all products named in this publication will always be available. The aforementioned does not apply in the case of individual agreements deviating from the foregoing for customer-specific products.
6. Unless otherwise agreed in individual contracts, **all orders are subject to the current version of the "General Terms of Delivery for Products and Services in the Electrical Industry" published by the German Electrical and Electronics Industry Association (ZVEI)**.
7. The trade names EPCOS, BAOKE, Alu-X, CeraDiode, CSSP, CTVS, DSSP, MiniBlue, MKK, MLSC, MotorCap, PCC, PhaseCap, PhaseMod, SIFERRIT, SIFI, SIKOREL, SilverCap, SIMDAD, SIMID, SineFormer, SIOV, SIP5D, SIP5K, ThermoFuse, WindCap are **trademarks registered or pending** in Europe and in other countries. Further information will be found on the Internet at www.epcos.com/trademarks.