

Aluminum electrolytic capacitors

Single-ended capacitors

Series/Type: B43858

Date: December 2014

Long-life grade capacitors

Applications

- Professional power supplies

Features

- High ripple current capability at high frequency
- Long useful life
- RoHS-compatible

Construction

- Radial leads
- Charge-discharge proof, polar
- Aluminum case with insulating sleeve
- Minus pole marking on the insulating sleeve
- Case with safety vent

Delivery mode

Terminal configurations and packing:

- Bulk
- Taped, Ammo pack
- Cut
- Kinked
- PAPR (protection against polarity reversal):
crimped leads, J leads, bent leads

Refer to chapter "Single-ended capacitors – Taping, packing and lead configurations" for further details.

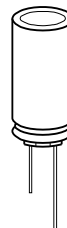

Specifications and characteristics in brief

Rated voltage V_R	160 ... 450 V DC			
Surge voltage V_S	$1.1 \cdot V_R$			
Rated capacitance C_R	2.2 ... 330 μF			
Capacitance tolerance	$\pm 20\% \triangle M$			
Dissipation factor $\tan \delta$ (20 °C, 120 Hz)	$V_R \leq 250 \text{ V DC: } \tan \delta \text{ (max.)} = 0.20$ $V_R \geq 350 \text{ V DC: } \tan \delta \text{ (max.)} = 0.24$			
Leakage current I_{leak} (20 °C, 5 min)	$I_{\text{leak}} = 0.03 \mu\text{A} \cdot \left(\frac{C_R}{\mu\text{F}} \cdot \frac{V_R}{\text{V}} \right) + 15 \mu\text{A}$			
Self-inductance ESL	Diameter (mm)	≤ 12.5	16	18
	ESL (nH)	20	26	34
Useful life ¹⁾ 105 °C; V_R ; $I_{\text{AC,R}}$ Requirements	$> 5000 \text{ h}$ $ \Delta C/C \leq 35\% \text{ of initial value}$ $\tan \delta \leq 3 \text{ times initial specified limit}$ $I_{\text{leak}} \leq \text{initial specified limit}$			
Voltage endurance test 105 °C; V_R Post test requirements	5000 h			
	$ \Delta C/C \leq 25\% \text{ of initial value}$ $\tan \delta \leq 2 \text{ times initial specified limit}$ $I_{\text{leak}} \leq \text{initial specified limit}$			
Vibration resistance test	To IEC 60068-2-6, test Fc: Frequency range 10 Hz ... 2 kHz, displacement amplitude 0.75 mm, acceleration max. 10 g, duration $3 \times 2 \text{ h}$. Capacitor rigidly clamped by the aluminum case.			
IEC climatic category	To IEC 60068-1: $V_R \leq 250 \text{ V: } 40/105/56 \text{ (} -40 \text{ °C/+105 °C/56 days damp heat test)}$ $V_R \geq 350 \text{ V: } 25/105/56 \text{ (} -25 \text{ °C/+105 °C/56 days damp heat test)}$			
Sectional specification	IEC 60384-4			

1) Refer to chapter "General technical information, 5 Useful life" on how to interpret useful life.



B43858

High ripple current – 105 °C

Dimensional drawings

With stand-off rubber seal

Diameters (mm): 10, 12.5, 16, 18

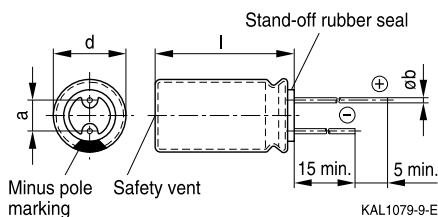

Dimensions and weights

Dimensions (mm)				Approx. weight
$d \pm 0.5$	l	$a \pm 0.5$	b	g
10	12.5 +1.0	5.0	0.60 ±0.05	1.6
10	16 +1.0	5.0	0.60 ±0.05	1.9
10	20 +2.0	5.0	0.60 ±0.05	2.6
12.5	20 +2.0	5.0	0.60 ±0.05	3.6
12.5	25 +2.0	5.0	0.60 ±0.05	4.5
16	20 +2.0	7.5	0.80 ±0.05	5.5
16	25 +2.0	7.5	0.80 ±0.05	7.5
16	31.5 +2.0	7.5	0.80 ±0.05	7.8
18	20 +2.0	7.5	0.80 ±0.1	8.0
18	25 +2.0	7.5	0.80 ±0.1	9.0
18	31.5 +2.0	7.5	0.80 ±0.1	11.0
18	35 +2.0	7.5	0.80 ±0.1	13.0
18	40 +2.0	7.5	0.80 ±0.1	16.0

Overview of available types

V_R (V DC)	160	200	250	350	400	450
	Case dimensions $d \times l$ (mm)					
C_R (μ F)						
2.2				10 × 12.5	10 × 12.5	10 × 12.5
3.3				10 × 12.5	10 × 16	10 × 16
4.7				10 × 12.5	10 × 16	10 × 16
6.8				10 × 16	10 × 16	10 × 16
10			10 × 16	10 × 16	10 × 20	10 × 20
22	10 × 16	10 × 16	10 × 20	12.5 × 20	12.5 × 25 16 × 20	16 × 20
33	10 × 16	10 × 20	12.5 × 20	12.5 × 25 16 × 20	16 × 20	16 × 25
47	12.5 × 20	12.5 × 20	12.5 × 25	16 × 25 18 × 20	16 × 31.5 18 × 25	16 × 31.5
68	12.5 × 20	12.5 × 25 16 × 20	16 × 20	16 × 31.5 18 × 25	18 × 31.5	18 × 35
82						18 × 40
100	16 × 20	16 × 25	16 × 31.5 18 × 25	18 × 35	18 × 40	
220	18 × 31.5	18 × 35	18 × 40			
330	18 × 40					

Other voltage and capacitance ratings are available upon request.

B43858
High ripple current – 105 °C
Technical data and ordering codes

C_R 120 Hz 20 °C μF	Case dimensions $d \times l$ mm	$I_{AC,R}$ 100 kHz 105 °C mA	Ordering code (composition see below)
$V_R = 160 \text{ V DC}$			
22	10 × 16	300	B43858G1226M***
33	10 × 16	350	B43858G1336M***
47	12.5 × 20	650	B43858G1476M***
68	12.5 × 20	700	B43858G1686M***
100	16 × 20	950	B43858G1107M***
220	18 × 31.5	1800	B43858G1227M***
330	18 × 40	2300	B43858G1337M***
$V_R = 200 \text{ V DC}$			
22	10 × 16	300	B43858G2226M***
33	10 × 20	470	B43858G2336M***
47	12.5 × 20	590	B43858G2476M***
68	12.5 × 25	780	B43858J2686M***
68	16 × 20	780	B43858G2686M***
100	16 × 25	1250	B43858G2107M***
220	18 × 35	2000	B43858G2227M***
$V_R = 250 \text{ V DC}$			
10	10 × 16	280	B43858L2106M***
22	10 × 20	480	B43858L2226M***
33	12.5 × 20	630	B43858L2336M***
47	12.5 × 25	790	B43858L2476M***
68	16 × 20	850	B43858L2686M***
100	16 × 31.5	1450	B43858L2107M***
100	18 × 25	1200	B43858M2107M***
220	18 × 40	2200	B43858L2227M***

Composition of ordering code

*** = Version

000 = for standard leads, bulk

 001 = for kinked leads, bulk (for $d \times l = 10 \times 20 \dots 12.5 \times 25$ mm and $\varnothing 16 \dots 18$ mm)

002 = for cut leads, bulk

 003 = for crimped leads, blister (for $\varnothing 16 \dots 18$ mm)

 004 = for J leads, blister (for $\varnothing 10 \dots 18$ mm, excluding $d \times l = 18 \times 40$ mm)

 008 = for taped leads, Ammo pack, lead spacing $F = 5.0$ mm (for $\varnothing 10 \dots 12.5$ mm)

 009 = for taped leads, Ammo pack, lead spacing $F = 7.5$ mm (for $\varnothing 16$ mm and $d \times l = 18 \times 20 \dots 18 \times 31.5$ mm)

 012 = for bent 90° leads, blister (for $\varnothing 16 \dots 18$ mm)

Technical data and ordering codes

C_R 120 Hz 20 °C μF	Case dimensions $d \times l$ mm	$I_{AC,R}$ 100 kHz 105 °C mA	Ordering code (composition see below)
$V_R = 350 \text{ V DC}$			
2.2	10 × 12.5	100	B43858G4225M***
3.3	10 × 12.5	130	B43858G4335M***
4.7	10 × 12.5	140	B43858G4475M***
6.8	10 × 16	200	B43858G4685M***
10	10 × 16	220	B43858G4106M***
22	12.5 × 20	450	B43858G4226M***
33	12.5 × 25	580	B43858G4336M***
33	16 × 20	580	B43858J4336M***
47	16 × 25	850	B43858G4476M***
47	18 × 20	820	B43858J4476M***
68	16 × 31.5	1100	B43858G4686M***
68	18 × 25	900	B43858J4686M***
100	18 × 35	1450	B43858G4107M***
$V_R = 400 \text{ V DC}$			
2.2	10 × 12.5	100	B43858G9225M***
3.3	10 × 16	130	B43858G9335M***
4.7	10 × 16	180	B43858G9475M***
6.8	10 × 16	190	B43858G9685M***
10	10 × 20	290	B43858G9106M***
22	12.5 × 25	520	B43858G9226M***
22	16 × 20	530	B43858J9226M***
33	16 × 20	650	B43858G9336M***
47	16 × 31.5	1050	B43858G9476M***
47	18 × 25	900	B43858J9476M***
68	18 × 31.5	1300	B43858G9686M***
100	18 × 40	1600	B43858G9107M***

Composition of ordering code

*** = Version

- 000 = for standard leads, bulk
- 001 = for kinked leads, bulk (for $d \times l = 10 \times 20 \dots 12.5 \times 25 \text{ mm}$ and $\varnothing 16 \dots 18 \text{ mm}$)
- 002 = for cut leads, bulk
- 003 = for crimped leads, blister (for $\varnothing 16 \dots 18 \text{ mm}$)
- 004 = for J leads, blister (for $\varnothing 10 \dots 18 \text{ mm}$, excluding $d \times l = 18 \times 40 \text{ mm}$)
- 008 = for taped leads, Ammo pack, lead spacing $F = 5.0 \text{ mm}$ (for $\varnothing 10 \dots 12.5 \text{ mm}$)
- 009 = for taped leads, Ammo pack, lead spacing $F = 7.5 \text{ mm}$ (for $\varnothing 16 \text{ mm}$ and $d \times l = 18 \times 20 \dots 18 \times 31.5 \text{ mm}$)
- 012 = for bent 90° leads, blister (for $\varnothing 16 \dots 18 \text{ mm}$)

B43858
High ripple current – 105 °C
Technical data and ordering codes

C_R 120 Hz 20 °C μF	Case dimensions $d \times l$ mm	$I_{AC,R}$ 100 kHz 105 °C mA	Ordering code (composition see below)
$V_R = 450 \text{ V DC}$			
2.2	10 × 12.5	100	B43858G5225M***
3.3	10 × 16	130	B43858G5335M***
4.7	10 × 16	150	B43858G5475M***
6.8	10 × 16	190	B43858G5685M***
10	10 × 20	310	B43858G5106M***
22	16 × 20	600	B43858G5226M***
33	16 × 25	800	B43858G5336M***
47	16 × 31.5	1050	B43858G5476M***
68	18 × 35	1350	B43858G5686M***
82	18 × 40	1600	B43858G5826M***

Composition of ordering code

*** = Version

000 = for standard leads, bulk

 001 = for kinked leads, bulk (for $d \times l = 10 \times 20 \dots 12.5 \times 25 \text{ mm}$ and $\varnothing 16 \dots 18 \text{ mm}$)

002 = for cut leads, bulk

 003 = for crimped leads, blister (for $\varnothing 16 \dots 18 \text{ mm}$)

 004 = for J leads, blister (for $\varnothing 10 \dots 18 \text{ mm}$, excluding $d \times l = 18 \times 40 \text{ mm}$)

 008 = for taped leads, Ammo pack, lead spacing $F = 5.0 \text{ mm}$ (for $\varnothing 10 \dots 12.5 \text{ mm}$)

 009 = for taped leads, Ammo pack, lead spacing $F = 7.5 \text{ mm}$ (for $\varnothing 16 \text{ mm}$ and $d \times l = 18 \times 20 \dots 18 \times 31.5 \text{ mm}$)

 012 = for bent 90° leads, blister (for $\varnothing 16 \dots 18 \text{ mm}$)

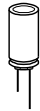

B43858

High ripple current – 105 °C

Useful life¹⁾

depending on ambient temperature T_A under ripple current operating conditions

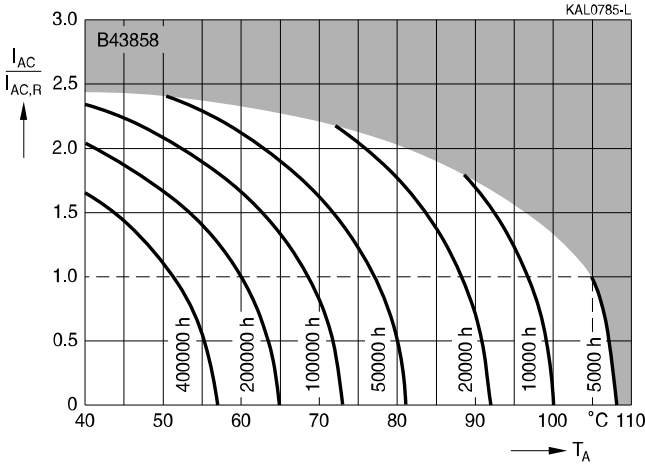

Frequency factor of permissible ripple current I_{AC} versus frequency f

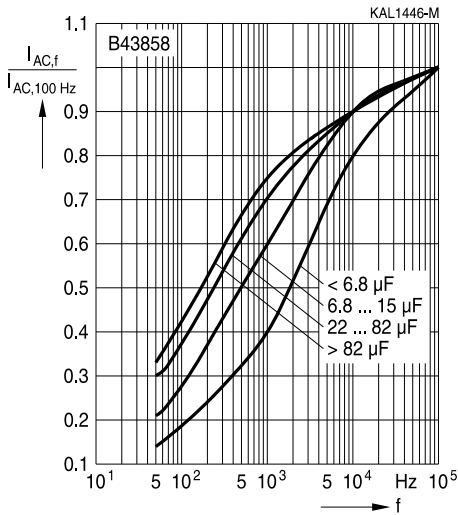

1) Refer to chapter "General technical information, 5 Useful life" on how to interpret useful life.



B43858

High ripple current – 105 °C

Taping, packing and lead configurations

Taping

Single-ended capacitors are available taped in Ammo pack from diameter 8 to 18 mm as follows:

- Lead spacing $F = 3.5$ mm ($\varnothing d = 8$ mm)
- Lead spacing $F = 5.0$ mm ($\varnothing d = 8 \dots 12.5$ mm)
- Lead spacing $F = 7.5$ mm ($\varnothing d = 16 \dots 18$ mm).

The dimensions for F , P_1 and 1 max. are specified with reference to the center of the terminal wires.

Lead spacing 3.5 mm ($\varnothing d = 8$ mm)

Last 3 digits of ordering code: 006

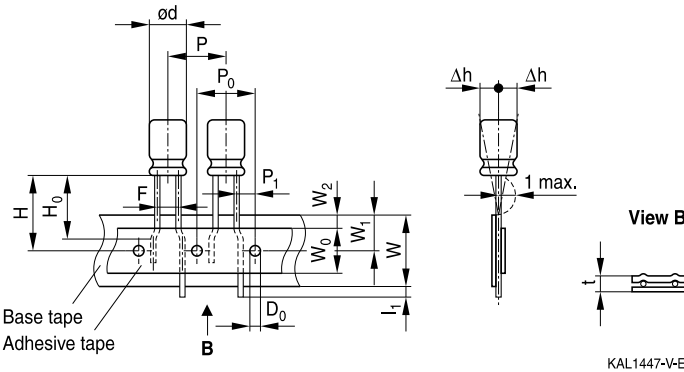

Dimensions in mm

$\varnothing d$	F	H	W	W_0	W_1	W_2	P	P_0	P_1	l_1	t	Δh	D_0
8	3.5	18.5	18.0	9.5	9.0	3.0	12.7	12.7	4.6	1.0	0.7	1.0	4.0
Tolerance	+0.8 -0.2	± 1.0	± 0.5	min.	± 0.5	max.	± 1.0	± 0.3	± 0.6	max.	± 0.2	max.	± 0.2

Leads can also run straight through the taping area.



B43858

High ripple current – 105 °C

Lead spacing 5.0 mm (∅ d = 8 mm)

Last 3 digits of ordering code: 008

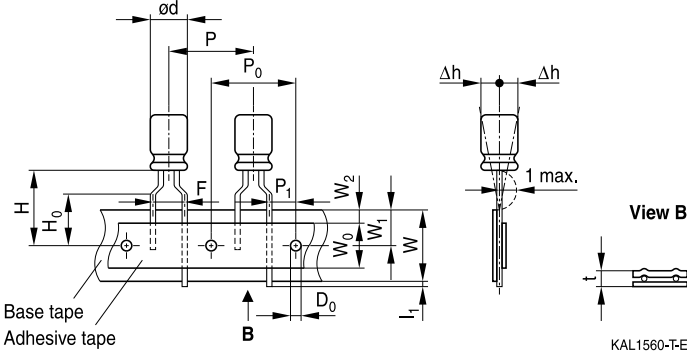

Lead spacing 5.0 mm (∅ d = 10 ... 12.5 mm)

Last 3 digits of ordering code: 008

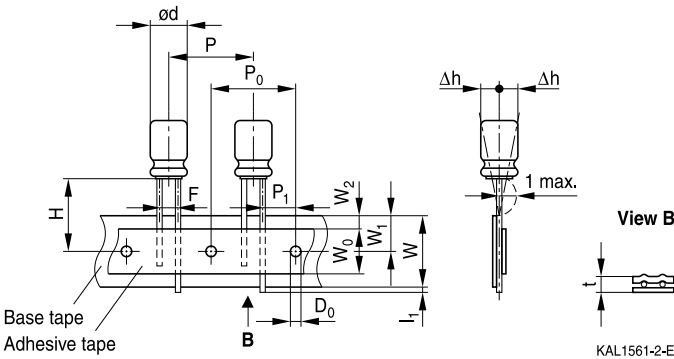

Dimensions in mm

∅ d	F	H	W	W ₀	W ₁	W ₂	H ₀	P	P ₀	P ₁	l ₁	t	Δh	D ₀
8		20.0		9.5			16.0	12.7	12.7	3.85				
10	5.0	19.0	18.0	9.5	9.0	1.5	–	12.7	12.7	3.85	1.0	0.6	1.0	4.0
12.5		19.0		11.5			–	15.0	15.0	5.0				
Tolerance	+0.8 –0.2	±0.75	±0.5	min.	±0.5	max.	±0.5	±1.0	±0.2	±0.5	max.	+0.3 –0.2	max.	±0.2

Taping is available up to dimensions d × l = 12.5 × 25 mm.



B43858

High ripple current – 105 °C

Lead spacing 7.5 mm (∅ d = 16 ...18 mm)

Last 3 digits of ordering code: 009

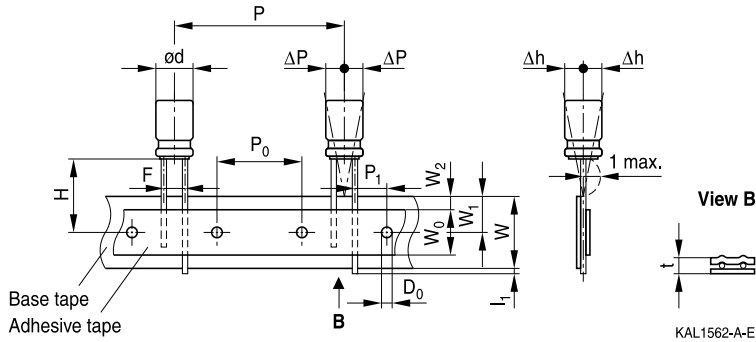

Dimensions in mm

∅ d	F	H	W	W ₀	W ₁	W ₂	P	P ₀	P ₁	l ₁	t	ΔP	Δh	D ₀
16	7.5	18.5	18.0	12.5	9.0	1.5	30.0	15.0	3.75	1.0	0.7	0	0	4.0
18														
Tolerance	±0.8	-0.5 +0.75	±0.5	min.	±0.5	max.	±1.0	±0.2	±0.5	max.	±0.2	±1.0	±1.0	±0.2

Taping is available up to dimensions d × l = 16 × 31.5 mm and 18 × 31.5 mm.



Cut or kinked leads

Single-ended capacitors are available with cut or kinked leads. Other lead configurations also available upon request.

Cut leads

Last 3 digits of ordering code: 002

With stand-off rubber seal

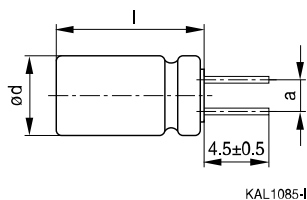

With flat rubber seal

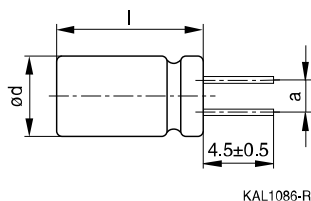

Case size d × l (mm)	Dimensions (mm) a ±0.5
10 × 12.5	5.0
10 × 16	5.0
10 × 20	5.0
12.5 × 20	5.0
12.5 × 25	5.0
16 × 20	7.5
16 × 25	7.5
16 × 31.5	7.5
16 × 35.5	7.5
18 × 20	7.5
18 × 25	7.5
18 × 31.5	7.5
18 × 35	7.5
18 × 40	7.5



B43858

High ripple current – 105 °C

Kinked leads

Last 3 digits of ordering code: 001

With stand-off rubber seal

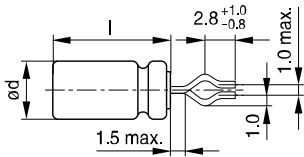

KAL1081-K

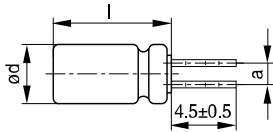

KAL1083-2

With flat rubber seal

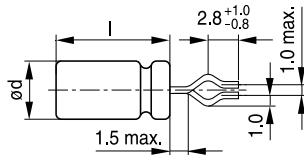

KAL1082-T

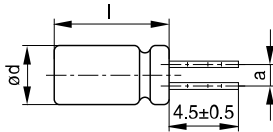

KAL1084-A

Case size d × l (mm)	Dimensions (mm) a ±0.5
10 × 20	5.0
12.5 × 20	5.0
12.5 × 25	5.0
16 × 20	7.5
16 × 25	7.5
16 × 31.5	7.5
16 × 35.5	7.5
18 × 20	7.5
18 × 25	7.5
18 × 31.5	7.5
18 × 35	7.5
18 × 40	7.5



PAPR leads (Protection Against Polarity Reversal)

These lead configurations ensure correct placement of the capacitor on the PCB with regard to polarity. PAPR leads are available for diameters from 10 mm up to 18 mm (excluding $d \times l = 12.5 \times 30/35/40$ mm).

There are three configurations available: Crimped leads, J leads, bent 90° leads.

Crimped leads

Last 3 digits of ordering code: 003

With stand-off rubber seal

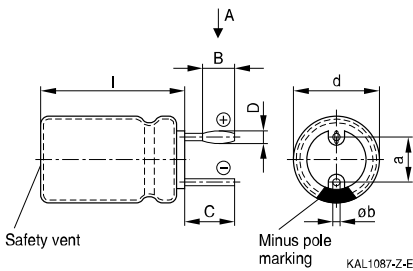

With flat rubber seal

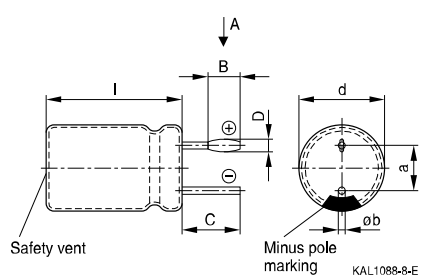

Suggestion for PCB hole diameter

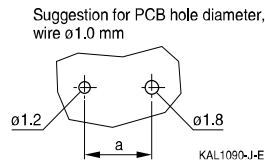
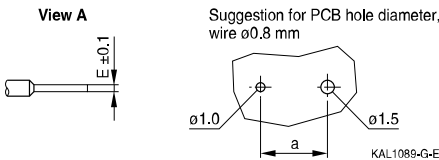

Case size $d \times l$ (mm)	Dimensions (mm)					
	B ± 0.2	C ± 0.5	D ± 0.1	E ± 0.1	a ± 0.5	$\varnothing b$
16 × 20	1.5	3.0	1.3	0.3	7.5	0.8 ± 0.05
16 × 25	1.5	3.0	1.3	0.3	7.5	0.8 ± 0.05
16 × 31.5	1.5	3.0	1.3	0.3	7.5	0.8 ± 0.05
16 × 35.5	1.5	3.0	1.3	0.3	7.5	0.8 ± 0.05
18 × 20	1.5	3.0	1.3	0.3	7.5	0.8 ± 0.1
18 × 25	1.5	3.0	1.3	0.3	7.5	0.8 ± 0.1
18 × 31.5	1.5	3.0	1.3	0.3	7.5	0.8 ± 0.1
18 × 35	1.5	3.0	1.3	0.3	7.5	0.8 ± 0.1
18 × 40	1.5	3.0	1.3	0.3	7.5	0.8 ± 0.1



B43858

High ripple current – 105 °C

J leads

Last 3 digits of ordering code: 004

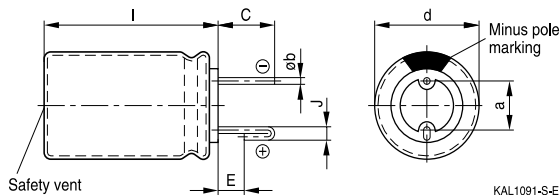

Suggestion for PCB hole diameter

Suggestion for PCB hole diameter, wire $\varnothing 0.6$ mm

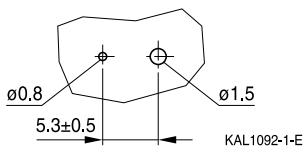

Suggestion for PCB hole diameter, wire $\varnothing 0.8$ mm

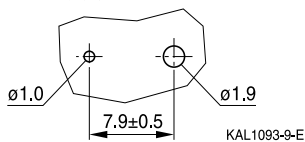

Case size d × l (mm)	Dimensions (mm)				
	C ±0.5	E ±0.5	J ±0.2	a ±0.5	∅b
10 × 12.5	3.2	0.7	1.2	5.0	0.6 ±0.05
10 × 16	3.2	0.7	1.2	5.0	0.6 ±0.05
10 × 20	3.2	0.7	1.2	5.0	0.6 ±0.05
12.5 × 20	3.2	0.7	1.2	5.0	0.6 ±0.05
12.5 × 25	3.2	0.7	1.2	5.0	0.6 ±0.05
16 × 20	3.5	0.7	1.6	7.5	0.8 ±0.05
16 × 25	3.5	0.7	1.6	7.5	0.8 ±0.05
16 × 31.5	3.5	0.7	1.6	7.5	0.8 ±0.05
16 × 35.5	3.5	0.7	1.6	7.5	0.8 ±0.05
18 × 20	3.5	0.7	1.6	7.5	0.8 ±0.1
18 × 25	3.5	0.7	1.6	7.5	0.8 ±0.1
18 × 31.5	3.5	0.7	1.6	7.5	0.8 ±0.1
18 × 35	3.5	0.7	1.6	7.5	0.8 ±0.1

Bent 90° leads for horizontal mounting pinning

Last 3 digits of ordering code: 012

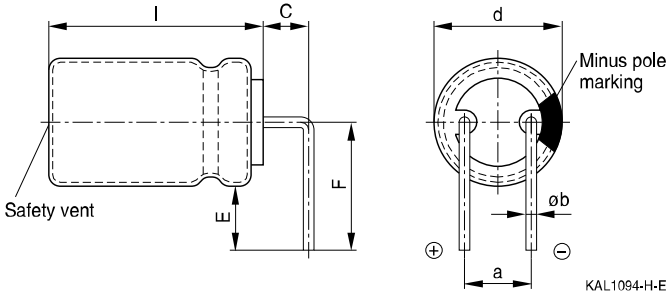

Case size d × l (mm)	Dimensions (mm)				
	C ±0.5	E ±0.5	F ±0.5	a ±0.5	Øb
16 × 20	4.0	4.0	12.0	7.5	0.8 ±0.05
16 × 25	4.0	4.0	12.0	7.5	0.8 ±0.05
16 × 31.5	4.0	4.0	12.0	7.5	0.8 ±0.05
16 × 35.5	4.0	4.0	12.0	7.5	0.8 ±0.05
18 × 20	4.0	4.0	13.0	7.5	0.8 ±0.1
18 × 25	4.0	4.0	13.0	7.5	0.8 ±0.1
18 × 31.5	4.0	4.0	13.0	7.5	0.8 ±0.1
18 × 35	4.0	4.0	13.0	7.5	0.8 ±0.1
18 × 40	4.0	4.0	13.0	7.5	0.8 ±0.1

Bent leads for diameter 12.5 mm available upon request.



B43858

High ripple current – 105 °C

Packing units and box dimensions

Ammo pack

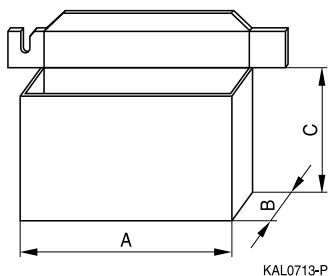

Case size d × l mm	Dimensions (mm)			Packing units pcs.
	A _{max}	B _{max}	C _{max}	
8 × 11.5	345	60	240	1000
10 × 12.5	345	60	280	750
10 × 16	345	65	200	500
10 × 20	345	65	200	500
12.5 × 20	345	65	260	500
12.5 × 25	345	65	260	500
16 × 20	320	65	285	300
16 × 25	320	65	285	300
16 × 31.5	320	75	275	300
18 × 20	320	65	285	250
18 × 25	320	65	285	250
18 × 31.5	320	75	275	250

Overview of packing units and code numbers for case sizes 8 × 11.5 ... 16 × 35.5

				PAPR					
Case size d × l	Stan- dard, bulk	Taped, Ammo pack	Kinked leads, bulk	Cut leads, bulk	Crimped leads, blister	J leads, blister	Bent 90° leads, blister		
mm	pcs.	pcs.	pcs.	pcs.	pcs.	pcs.	pcs.		
8 × 11.5	1000	1000	–	–	–	–			
10 × 12.5	1000	750	–	1000	–	675			
10 × 16	1000	500	–	1000	–	675			
10 × 20	500	500	500	500	–	500			
12.5 × 20	350	500	350	350	–	300	1)		
12.5 × 25	250	500	500	500	–	225	1)		
12.5 × 30	200	–	–	–	–	–			
12.5 × 35	175	–	–	–	–	–			
12.5 × 40	175	–	–	–	–	–			
16 × 20	250	300	200	200	200	200	120		
16 × 25	250	300	200	200	200	200	216		
16 × 31.5	200	300	250	250	344	344	180		
16 × 35.5	100	–	100	100	150	150	150		
The last three digits of the complete ordering code state the lead configuration	000	Code	F (mm)	d (mm)	001	002	003	004	012
		006	3.5	8					
		008	5	8...12.5					
		009	7.5	16...18					

1) Available upon request



B43858

High ripple current – 105 °C

Overview of packing units and code numbers for case sizes 18 × 20 ... 18 × 40

					PAPR				
Case size d × l mm	Standard, bulk pcs.	Taped, Ammo pack pcs.			Kinked leads, bulk pcs.	Cut leads, bulk pcs.	Crimped leads, blister pcs.	J leads, blister pcs.	Bent 90° leads, blister pcs.
18 × 20	175	250			175	175	200	200	120
18 × 25	150	250			150	150	200	200	120
18 × 31.5	100	250			100	100	150	150	120
18 × 35	100	–			100	100	150	150	150
18 × 40	125	–			100	100	120	–	72
The last three digits of the complete ordering code state the lead configuration	000	Code	F (mm)	d (mm)	001	002	003	004	012
		009	7.5	16...18					



Cautions and warnings

Personal safety

The electrolytes used by EPCOS have been optimized both with a view to the intended application and with regard to health and environmental compatibility. They do not contain any solvents that are detrimental to health, e.g. dimethyl formamide (DMF) or dimethyl acetamide (DMAC).

Furthermore, some of the high-voltage electrolytes used by EPCOS are self-extinguishing.

As far as possible, EPCOS does not use any dangerous chemicals or compounds to produce operating electrolytes. However, in exceptional cases, such materials must be used in order to achieve specific physical and electrical properties because no alternative materials are currently known. However, the amount of dangerous materials used in our products is limited to an absolute minimum.

Materials and chemicals used in EPCOS aluminum electrolytic capacitors are continuously adapted in compliance with the EPCOS Corporate Environmental Policy and the latest EU regulations and guidelines such as RoHS, REACH/SVHC, GADSL, and ELV.

MDS (Material Data Sheets) are available on the EPCOS website for all types listed in the data book. MDS for customer specific capacitors are available upon request.

MSDS (Material Safety Data Sheets) are available for all of our electrolytes upon request.

Nevertheless, the following rules should be observed when handling aluminum electrolytic capacitors: No electrolyte should come into contact with eyes or skin. If electrolyte does come into contact with the skin, wash the affected areas immediately with running water. If the eyes are affected, rinse them for 10 minutes with plenty of water. If symptoms persist, seek medical treatment. Avoid inhaling electrolyte vapor or mists. Workplaces and other affected areas should be well ventilated. Clothing that has been contaminated by electrolyte must be changed and rinsed in water.



B43858

High ripple current – 105 °C

Product safety

The table below summarizes the safety instructions that must be observed without fail. A detailed description can be found in the relevant sections of chapter "General technical information".

Topic	Safety information	Reference chapter "General technical information"
Polarity	Make sure that polar capacitors are connected with the right polarity.	1 "Basic construction of aluminum electrolytic capacitors"
Reverse voltage	Voltages of opposite polarity should be prevented by connecting a diode.	3.1.6 "Reverse voltage"
Mounting position of screw-terminal capacitors	Screw terminal capacitors must not be mounted with terminals facing down unless otherwise specified.	11.1. "Mounting positions of capacitors with screw terminals"
Robustness of terminals	The following maximum tightening torques must not be exceeded when connecting screw terminals: M5: 2.5 Nm M6: 4.0 Nm	11.3 "Mounting torques"
Mounting of single-ended capacitors	The internal structure of single-ended capacitors might be damaged if excessive force is applied to the lead wires. Avoid any compressive, tensile or flexural stress. Do not move the capacitor after soldering to PC board. Do not pick up the PC board by the soldered capacitor. Do not insert the capacitor on the PC board with a hole space different to the lead space specified.	11.4 "Mounting considerations for single-ended capacitors"
Soldering	Do not exceed the specified time or temperature limits during soldering.	11.5 "Soldering"
Soldering, cleaning agents	Do not allow halogenated hydrocarbons to come into contact with aluminum electrolytic capacitors.	11.6 "Cleaning agents"
Upper category temperature	Do not exceed the upper category temperature.	7.2 "Maximum permissible operating temperature"
Passive flammability	Avoid external energy, e.g. fire.	8.1 "Passive flammability"



Topic	Safety information	Reference chapter "General technical information"
Active flammability	Avoid overload of the capacitors.	8.2 "Active flammability"
Maintenance	Make periodic inspections of the capacitors. Before the inspection, make sure that the power supply is turned off and carefully discharge the electricity of the capacitors. Do not apply excessive mechanical stress to the capacitor terminals when mounting.	10 "Maintenance"
Storage	Do not store capacitors at high temperatures or high humidity. Capacitors should be stored at +5 to +35 °C and a relative humidity of ≤ 75%.	7.3 "Shelf life and storage conditions"
		Reference chapter "Capacitors with screw terminals"
Breakdown strength of insulating sleeves	Do not damage the insulating sleeve, especially when ring clips are used for mounting.	"Screw terminals – accessories"

Display of ordering codes for EPCOS products

The ordering code for one and the same product can be represented differently in data sheets, data books, other publications and the website of EPCOS, or in order-related documents such as shipping notes, order confirmations and product labels. The varying representations of the ordering codes are due to different processes employed and do not affect the specifications of the respective products. Detailed information can be found on the Internet under www.epcos.com/orderingcodes

B43858
High ripple current – 105 °C
Symbols and terms

Symbol	English	German
C	Capacitance	Kapazität
C_R	Rated capacitance	Nennkapazität
C_S	Series capacitance	Serienkapazität
$C_{S,T}$	Series capacitance at temperature T	Serienkapazität bei Temperatur T
C_f	Capacitance at frequency f	Kapazität bei Frequenz f
d	Case diameter, nominal dimension	Gehäusedurchmesser, Nennmaß
d_{max}	Maximum case diameter	Maximaler Gehäusedurchmesser
ESL	Self-inductance	Eigeninduktivität
ESR	Equivalent series resistance	Ersatzserienwiderstand
ESR_f	Equivalent series resistance at frequency f	Ersatzserienwiderstand bei Frequenz f
ESR_T	Equivalent series resistance at temperature T	Ersatzserienwiderstand bei Temperatur T
f	Frequency	Frequenz
I	Current	Strom
I_{AC}	Alternating current (ripple current)	Wechselstrom
$I_{AC,RMS}$	Root-mean-square value of alternating current	Wechselstrom, Effektivwert
$I_{AC,f}$	Ripple current at frequency f	Wechselstrom bei Frequenz f
$I_{AC,max}$	Maximum permissible ripple current	Maximal zulässiger Wechselstrom
$I_{AC,R}$	Rated ripple current	Nennwechselstrom
I_{leak}	Leakage current	Reststrom
$I_{leak,op}$	Operating leakage current	Betriebsreststrom
l	Case length, nominal dimension	Gehäuselänge, Nennmaß
l_{max}	Maximum case length (without terminals and mounting stud)	Maximale Gehäuselänge (ohne Anschlüsse und Gewindebolzen)
R	Resistance	Widerstand
R_{ins}	Insulation resistance	Isolationswiderstand
R_{symm}	Balancing resistance	Symmetrierwiderstand
T	Temperature	Temperatur
ΔT	Temperature difference	Temperaturdifferenz
T_A	Ambient temperature	Umgebungstemperatur
T_C	Case temperature	Gehäusetemperatur
T_B	Capacitor base temperature	Temperatur des Gehäusebodens
t	Time	Zeit
Δt	Period	Zeitraum
t_b	Service life (operating hours)	Brauchbarkeitsdauer (Betriebszeit)



Symbol	English	German
V	Voltage	Spannung
V _F	Forming voltage	Formierspannung
V _{op}	Operating voltage	Betriebsspannung
V _R	Rated voltage, DC voltage	Nennspannung, Gleichspannung
V _S	Surge voltage	Spitzenspannung
X _C	Capacitive reactance	Kapazitiver Blindwiderstand
X _L	Inductive reactance	Induktiver Blindwiderstand
Z	Impedance	Scheinwiderstand
Z _T	Impedance at temperature T	Scheinwiderstand bei Temperatur T
tan δ	Dissipation factor	Verlustfaktor
λ	Failure rate	Ausfallrate
ε ₀	Absolute permittivity	Elektrische Feldkonstante
ε _r	Relative permittivity	Dielektrizitätszahl
ω	Angular velocity; 2 · π · f	Kreisfrequenz; 2 · π · f

Note

All dimensions are given in mm.

Important notes

The following applies to all products named in this publication:

1. Some parts of this publication contain **statements about the suitability of our products for certain areas of application**. These statements are based on our knowledge of typical requirements that are often placed on our products in the areas of application concerned. We nevertheless expressly point out **that such statements cannot be regarded as binding statements about the suitability of our products for a particular customer application**. As a rule, EPCOS is either unfamiliar with individual customer applications or less familiar with them than the customers themselves. For these reasons, it is always ultimately incumbent on the customer to check and decide whether an EPCOS product with the properties described in the product specification is suitable for use in a particular customer application.
2. We also point out that **in individual cases, a malfunction of electronic components or failure before the end of their usual service life cannot be completely ruled out in the current state of the art, even if they are operated as specified**. In customer applications requiring a very high level of operational safety and especially in customer applications in which the malfunction or failure of an electronic component could endanger human life or health (e.g. in accident prevention or lifesaving systems), it must therefore be ensured by means of suitable design of the customer application or other action taken by the customer (e.g. installation of protective circuitry or redundancy) that no injury or damage is sustained by third parties in the event of malfunction or failure of an electronic component.
3. **The warnings, cautions and product-specific notes must be observed.**
4. In order to satisfy certain technical requirements, **some of the products described in this publication may contain substances subject to restrictions in certain jurisdictions (e.g. because they are classed as hazardous)**. Useful information on this will be found in our Material Data Sheets on the Internet (www.epcos.com/material). Should you have any more detailed questions, please contact our sales offices.
5. We constantly strive to improve our products. Consequently, **the products described in this publication may change from time to time**. The same is true of the corresponding product specifications. Please check therefore to what extent product descriptions and specifications contained in this publication are still applicable before or when you place an order. We also **reserve the right to discontinue production and delivery of products**. Consequently, we cannot guarantee that all products named in this publication will always be available. The aforementioned does not apply in the case of individual agreements deviating from the foregoing for customer-specific products.
6. Unless otherwise agreed in individual contracts, **all orders are subject to the current version of the "General Terms of Delivery for Products and Services in the Electrical Industry" published by the German Electrical and Electronics Industry Association (ZVEI)**.

Important notes

7. The trade names EPCOS, Alu-X, CeraDiode, CeraLink, CeraPad, CeraPlas, CSMP, CSSP, CTVS, DeltaCap, DigiSiMic, DSSP, FilterCap, FormFit, LeaXield, MiniBlue, MiniCell, MKD, MKK, MLSC, MotorCap, PCC, PhaseCap, PhaseCube, PhaseMod, PhiCap, PQSine, SIFERRIT, SIFI, SIKOREL, SilverCap, SIMDAD, SiMic, SIMID, SineFormer, SIOV, SIP5D, SIP5K, TFAP, ThermoFuse, WindCap are **trademarks registered or pending** in Europe and in other countries. Further information will be found on the Internet at www.epcos.com/trademarks.vvv