

Features

- Guard Ring Die Construction for Transient Protection
- Ideally Suited for Automatic Assembly
- Low Power Loss, High Efficiency
- Surge Overload Rating to 175A Peak
- For Use in Low Voltage, High Frequency Inverters, Free Wheeling, and Polarity Protection Application

Mechanical Data

- Case: Molded Plastic
- Plastic Material - UL Flammability Classification 94V-0
- Moisture sensitivity: Level 1 per J-STD-020A
- Terminals: Solder Plated Terminal Solderable per MIL-STD-202, Method 208
- Also Available in Lead Free Plating (Matte Tin Finish). Please see Ordering Information, Note 4, on Page 2
- Polarity: Cathode Band or Cathode Notch
- Approx. Weight: 0.21 grams
- Marking: Type Number

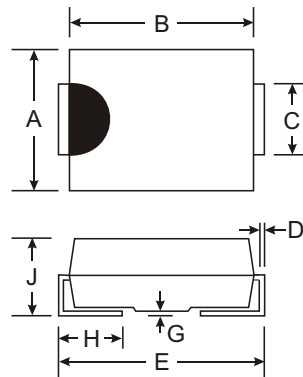

SMC		
Dim	Min	Max
A	5.59	6.22
B	6.60	7.11
C	2.75	3.18
D	0.15	0.31
E	7.75	8.13
G	0.10	0.20
H	0.76	1.52
J	2.00	2.62
All Dimensions in mm		

Maximum Ratings and Electrical Characteristics @ T_A = 25°C unless otherwise specified

Single phase, half wave, 60Hz, resistive or inductive load.
For capacitive load, derate current by 20%.

Characteristic	Symbol	B520C	B530C	B540C	B550C	B560C	Unit
Peak Repetitive Reverse Voltage	V _{RRM}	20	30	40	50	60	V
Working Peak Reverse Voltage	V _{RWM}						
DC Blocking Voltage	V _R						
RMS Reverse Voltage	V _{R(RMS)}	14	21	28	35	42	V
Average Rectified Output Current @ T _T = 90°C	I _O	5.0					A
Non-Repetitive Peak Forward Surge Current, 8.3 ms single half-sine-wave Superimposed on Rated Load (JEDEC method)	I _{FSM}	175					A
Forward Voltage @ I _F = 5.0A DC	V _{FM}	0.55			0.70		V
Peak Reverse Current @ T _A = 25°C at Rated DC Blocking Voltage @ T _A = 100°C	I _{RM}	0.5			20		mA
Typical Total Capacitance (Note 2)	C _T	300					pF
Typical Thermal Resistance, Junction to Terminal (Note 1)	R _{θJT}	10					K/W
Typical Thermal Resistance, Junction to Ambient	R _{θJA}	50					°C/W
Operating Temperature Range	T _J	-55 to +125					°C
Storage Temperature Range	T _{STG}	-55 to +150					°C

Notes: 1. Thermal Resistance: Junction to terminal, unit mounted on PC board with 5.0 mm² (0.013 mm thick) copper pads as heat sink.
2. Measured at 1.0 MHz and applied reverse voltage of 4.0V DC.

Ordering Information (Note 3 & 4)

Device*	Packaging	Shipping
B5xC-13	SMC	3000/Tape & Reel

Notes: 3. For Packaging Details, go to our website at <http://www.diodes.com/datasheets/ap02007.pdf>.

*x = Device type, e.g. B530C.

4. For lead free terminal plating part number, please add "-F" suffix to part number above. Example: B550-13-F.

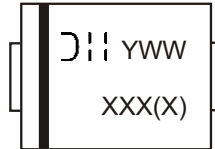

XXXX = Product type marking code, ex: B540C (SMC package)

Di = Manufacturers' code marking

YWW = Date code marking

Y = Last digit of year ex: 2 for 2002

WW = Week code 01 to 52

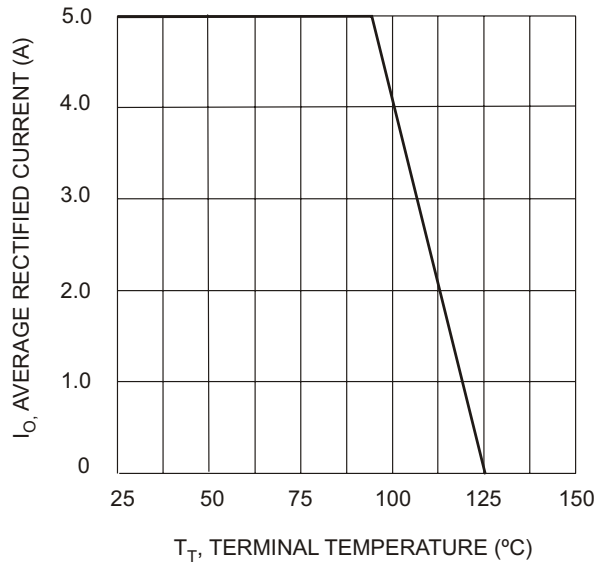

Fig. 1 Forward Current Derating Curve

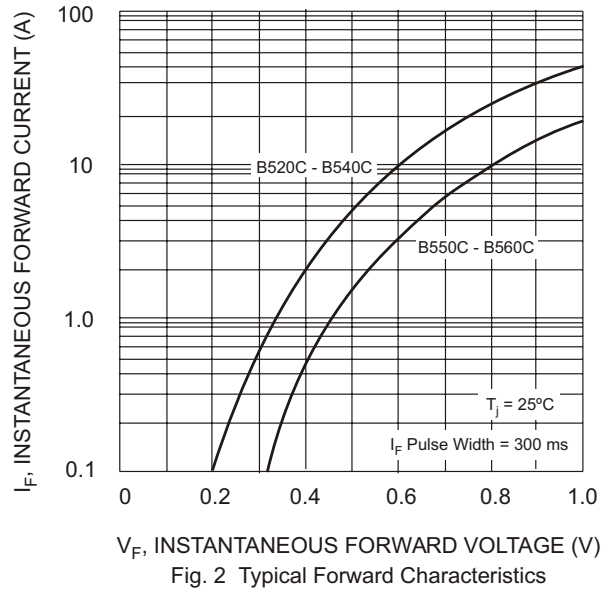

Fig. 2 Typical Forward Characteristics

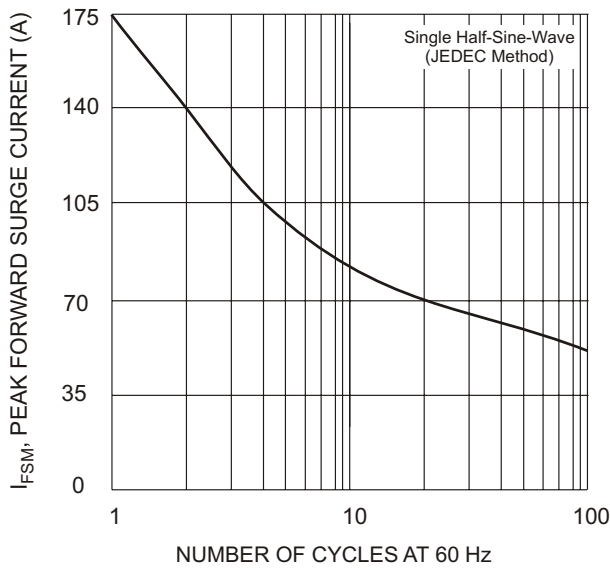

Fig. 3 Max Non-Repetitive Peak Forward Surge Current

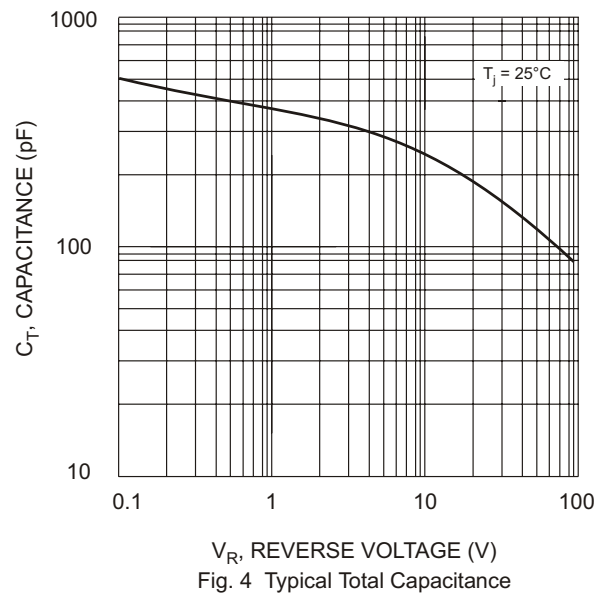

Fig. 4 Typical Total Capacitance

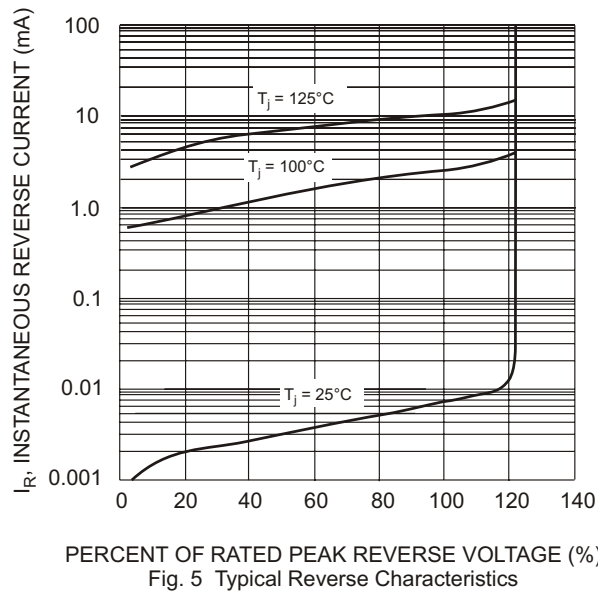

Fig. 5 Typical Reverse Characteristics