

SCHOTTKY BARRIER RECTIFIERS

Features

- Metal silicon junction, majority carrier conduction
- Guarding for overvoltage protection
- Low power loss, high efficiency
- High current capability
- low forward voltage drop
- High surge capability
- For use in low voltage, high frequency inverters, free wheeling, and polarity protection applications

PINNING

PIN	DESCRIPTION
1	Cathode
2	Anode

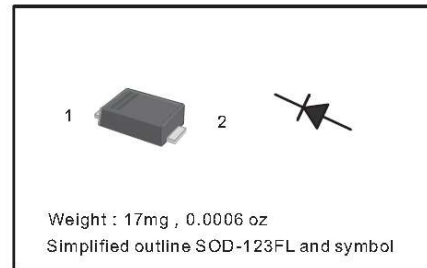

Maximum Ratings and Electrical characteristics

Ratings at 25 °C ambient temperature unless otherwise specified.

Parameter	Symbols	B5817WL	B5818WL	B5819WL	Units
Maximum Repetitive Peak Reverse Voltage	V_{RRM}	20	30	40	V
Maximum RMS voltage	V_{RMS}	14	21	28	V
Maximum DC Blocking Voltage	V_{DC}	20	30	40	V
Maximum Average Forward Rectified Current 0.375" (9.5 mm) Lead Length at $T_L = 90^\circ\text{C}$	$I_{F(AV)}$	1			A
Peak Forward Surge Current, 8.3ms Single Half Sine-wave Superimposed On Rated Load (JEDEC method) at $T_L = 70^\circ\text{C}$	I_{FSM}	25			A
Maximum Instantaneous Forward Voltage at 1 A Maximum Instantaneous Forward Voltage at 3.1 A	V_F	0.45 0.75	0.55 0.875	0.6 0.9	V
Maximum Instantaneous Reverse Current at $T_A = 25^\circ\text{C}$ Rated DC Reverse Voltage $T_A = 100^\circ\text{C}$	I_R	1 10			mA
Typical Thermal Resistance	$R_{\theta JA}$ $R_{\theta JL}$	50 15			$^\circ\text{C/W}$
Typical Junction Capacitance	C_j	110			pF
Storage and Operating Junction Temperature Range	T_j, T_{stg}	-55 ~ +125			$^\circ\text{C}$

SHIKE MAKE CONSCIOUS PRODUCT

CONSCIOUS PRODUCTS BEGIN WITH CONSCIOUS PEOPLE

REV.07



www.shike.tw

Fig.1 Forward Current Derating Curve

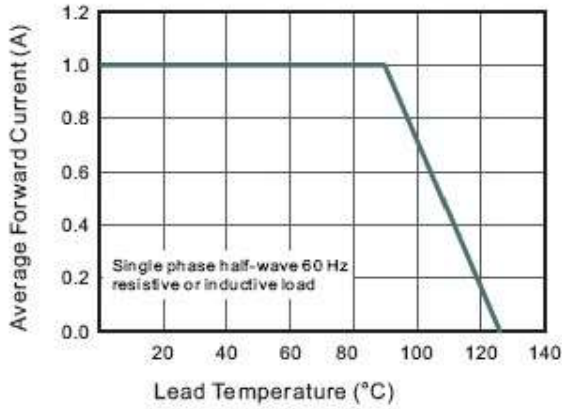

Fig.2 Typical Reverse Characteristics

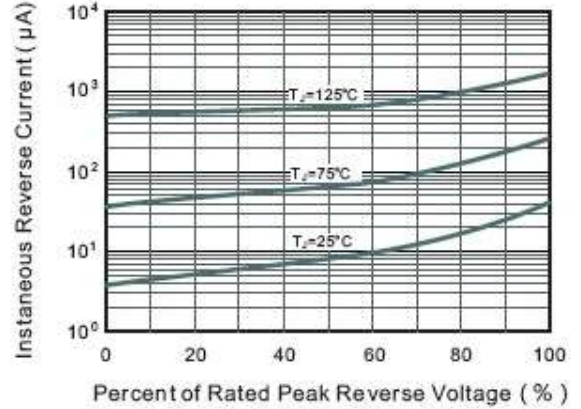

Fig.3 Typical Forward Characteristic

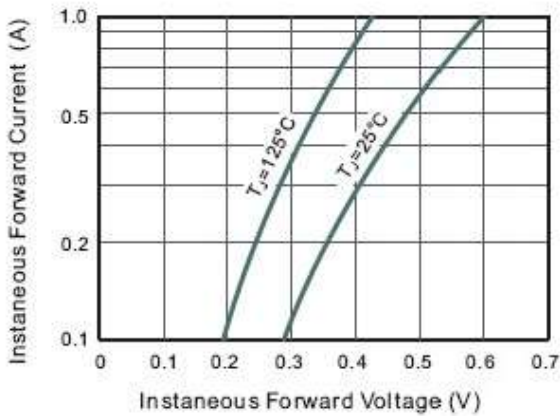

Fig.4 Typical Junction Capacitance

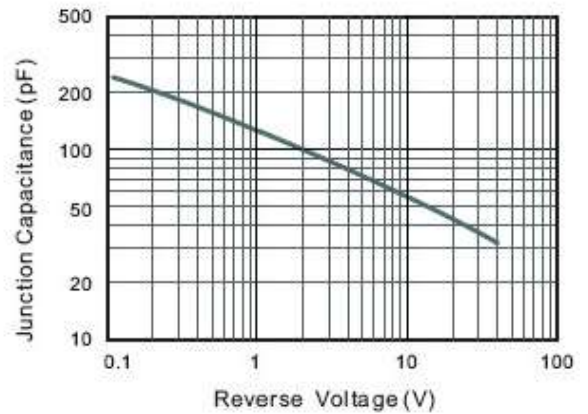

Fig.5 Maximum Non-Repetitive Peak Forward Surge Current

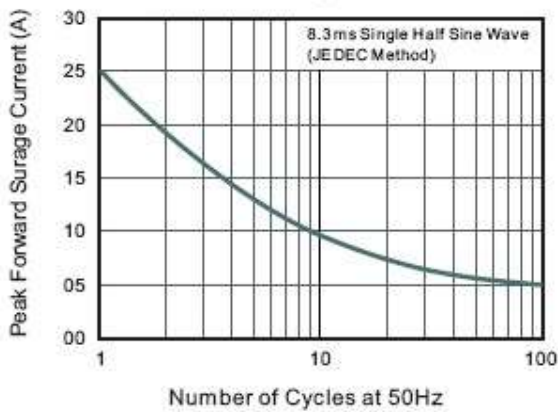
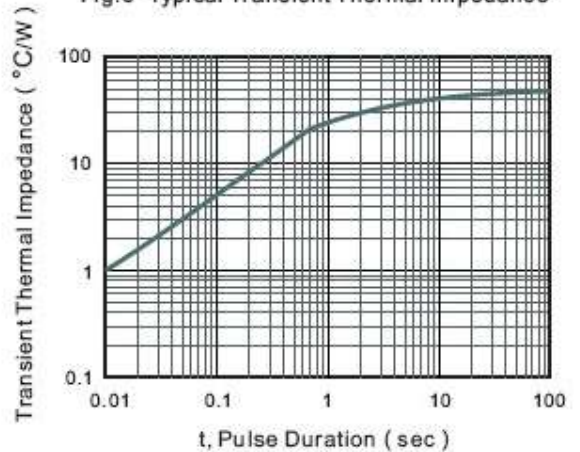

Fig.6- Typical Transient Thermal Impedance



PACKAGE OUTLINE

Plastic surface mounted package; 2 leads

SOD123FL

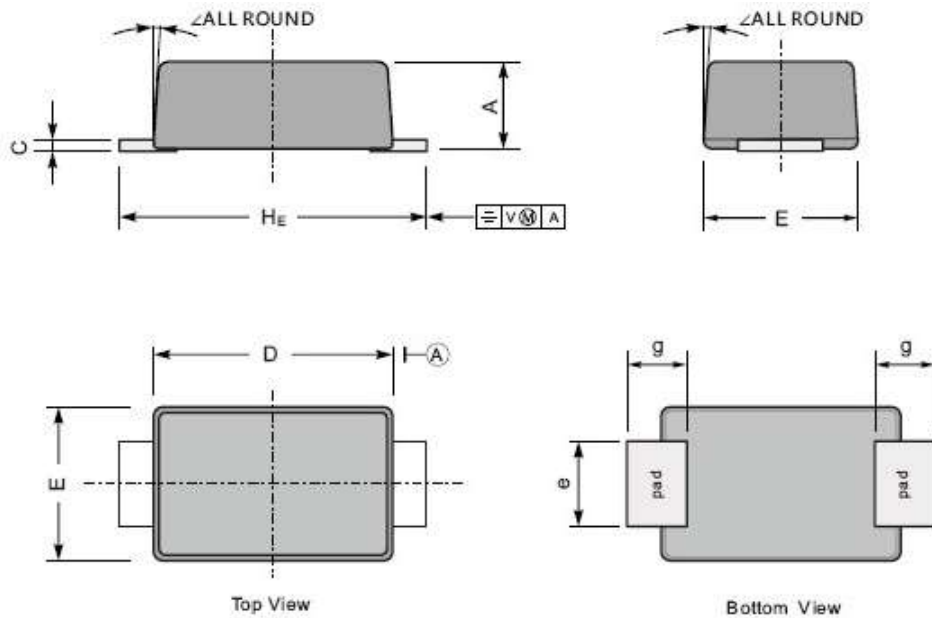

UNIT		A	C	D	E	e	g	H _E	∠
mm	max	1.1	0.20	2.9	1.9	1.1	0.9	3.8	7°
	min	0.9	0.12	2.6	1.7	0.8	0.7	3.5	
mil	max	43	7.9	114	75	43	35	150	
	min	35	4.7	102	67	31	28	138	

Marking

Type number marking code

B5817WL	SJ
B5818WL	SK
B5819WL	SL

The recommended mounting pad size

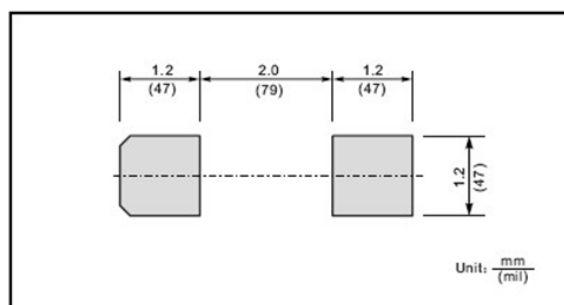

SHIKE MAKE CONSCIOUS PRODUCT
CONSCIOUS PRODUCTS BEGIN WITH CONSCIOUS PEOPLE



• Recommended condition of flow soldering

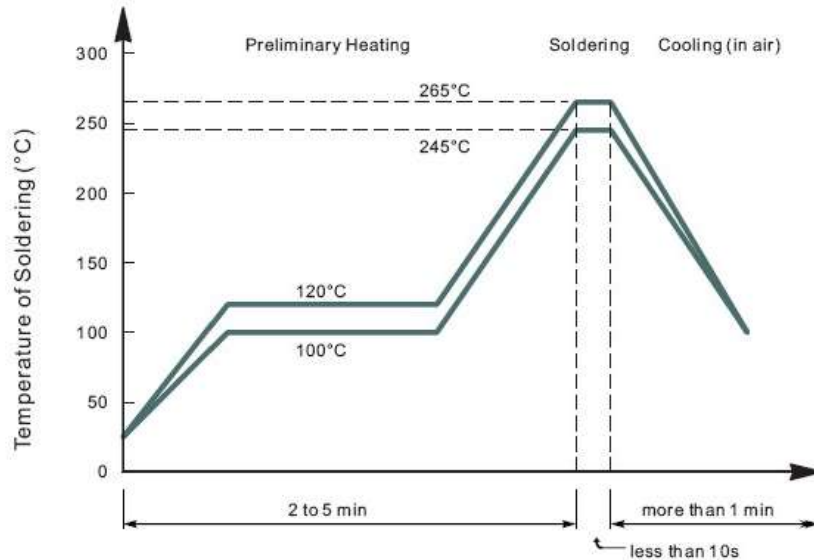

• Recommended condition of reflow soldering

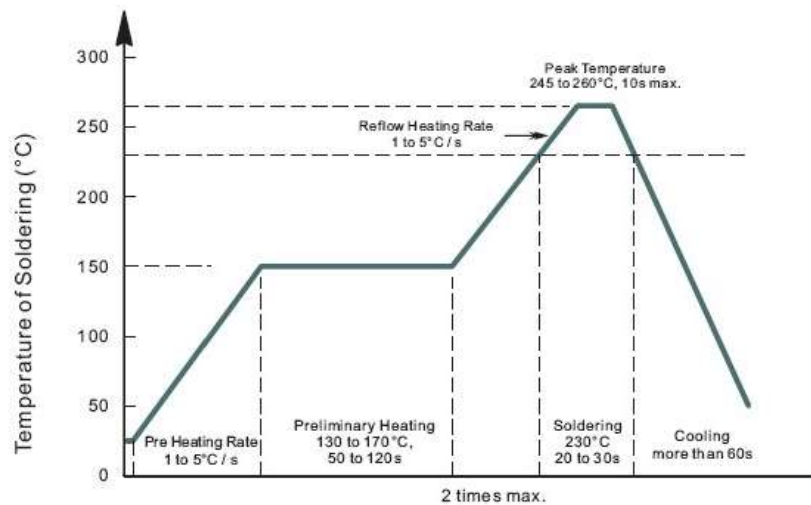

Recommended peak temperature is over 245 °C. If peak temperature is below 245 °C, you may adjust the following parameters; time length of peak temperature (longer), time length of soldering (longer), thickness of solder paste (thicker)

• Condition of hand soldering

Temperature: 320°C

Time: 3s max.

Times: one time

• Remark:

Lead free solder paste (96.5Sn/3.0Ag/0.5Cu)

SHIKE MAKE CONSCIOUS PRODUCT

CONSCIOUS PRODUCTS BEGIN WITH CONSCIOUS PEOPLE

