

● FEATURES

- Extremely low V_F .
- Low stored charge, majority carrier conduction.
- Low power loss/high efficient

● APPLICATIONS

- For Use In Low Voltage, High Frequency Inverters.
- Free Wheeling, And Polarity Protection Applications.

● ORDERING INFORMATION



Type No.	Marking	Package Code
B5817WS	SJ	SOD-323
B5818WS	SK	SOD-323
B5819WS	SL	SOD-323

● MAXIMUM RATING @ $T_a=25^{\circ}\text{C}$ unless otherwise specified

Parameter	symbol	B5817WS	B5818WS	B5819WS	Unit
Non-Repetitive Peak reverse voltage	V_{RM}	20	30	40	V
Peak repetitive Peak reverse voltage	V_{RRM}				
Working Peak Reverse voltage	V_{RWM}	20	30	40	V
DC Reverse Voltage	V_R				
RMS Reverse Voltage	$V_{R(RMS)}$	14	21	28	V
Average Rectified output Current	I_o	1			A
Peak forward surge current@=8.3ms	I_{FSM}	20			A
Power Dissipation	P_d	250			mW
Thermal Resistance Junction to Ambient	$R_{\theta JA}$	500			$^{\circ}\text{C}/\text{W}$
Storage temperature	T_{STG}	-65~+150			$^{\circ}\text{C}$

● ELECTRICAL CHARACTERISTICS @ Ta=25°C unless otherwise specified

Parameter	Symbol	Test Condition	MIN	MAX	UNIT
Reverse breakdown voltage	$V_{(BR)}$	$I_R=1\text{mA}$			V
		B5817WS	20		
		B5818WS	30		
Reverse voltage leakage current	I_R	$V_R=20\text{V}$	B5817WS		mA
		$V_R=30\text{V}$	B5818WS	1	
		$V_R=40\text{V}$	B5819WS		
Forward voltage	V_F	B5817WS	$I_F=1\text{A}$	0.45	V
			$I_F=3\text{A}$	0.75	
		B5818WS	$I_F=1\text{A}$	0.55	
			$I_F=3\text{A}$	0.875	
		B5819WS	$I_F=1\text{A}$	0.6	
			$I_F=3\text{A}$	0.9	
Diode capacitance	C_D	$V_R=4\text{V}, f=1\text{MHz}$		120	pF

● TYPICAL CHARACTERISTICS @ Ta=25°C unless otherwise specified

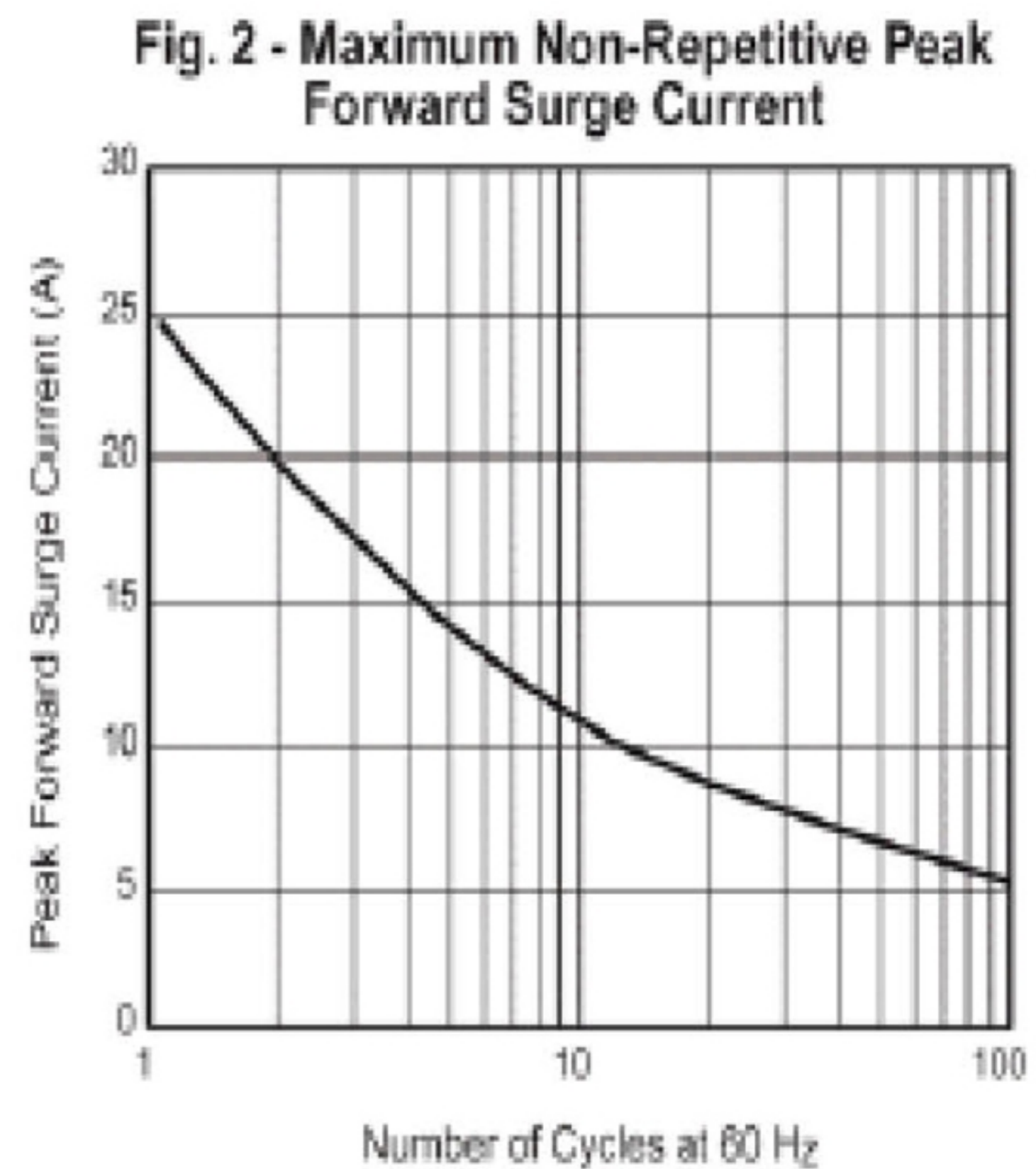
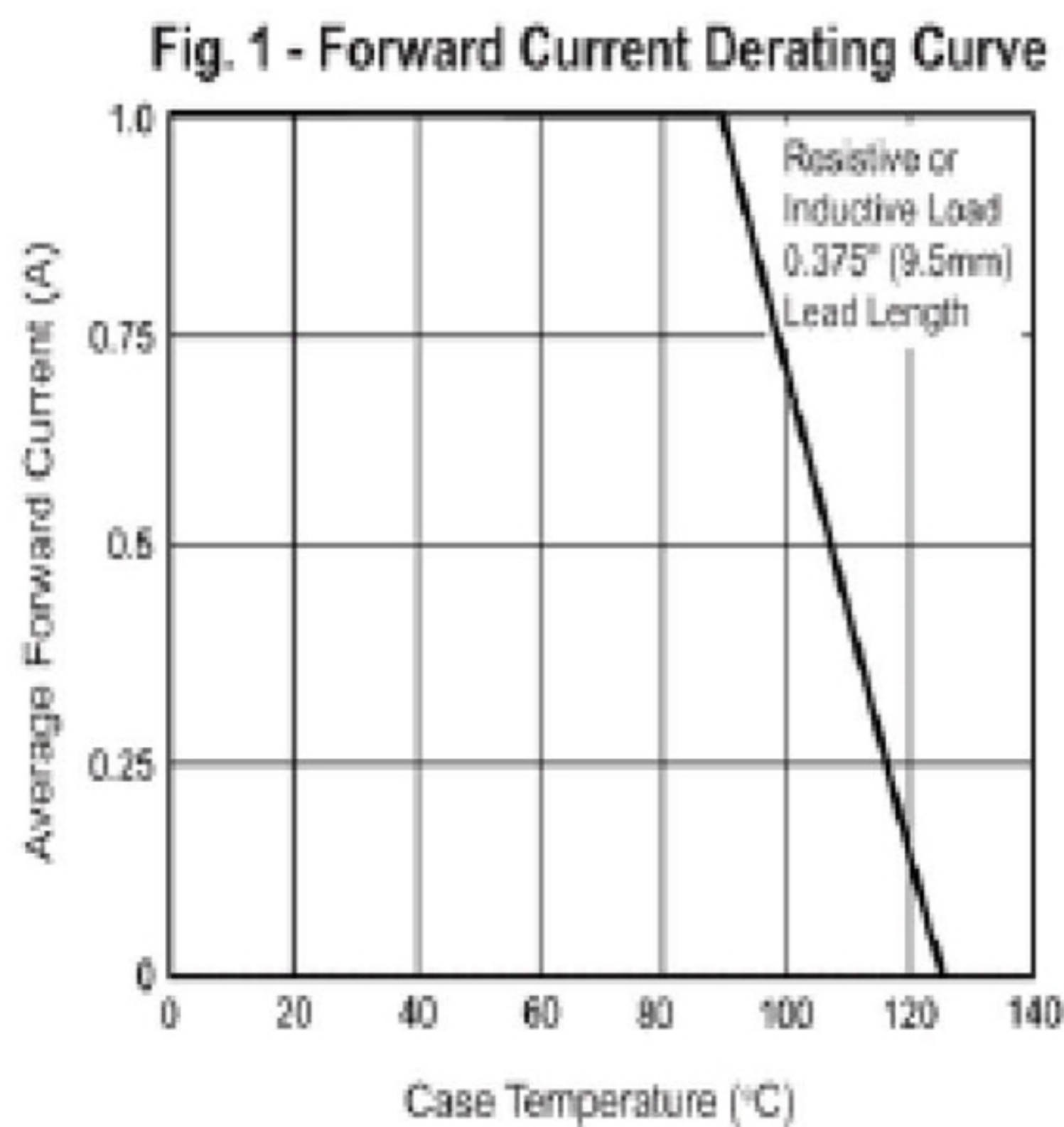

Fig. 3 - Typical Instantaneous Forward Characteristics

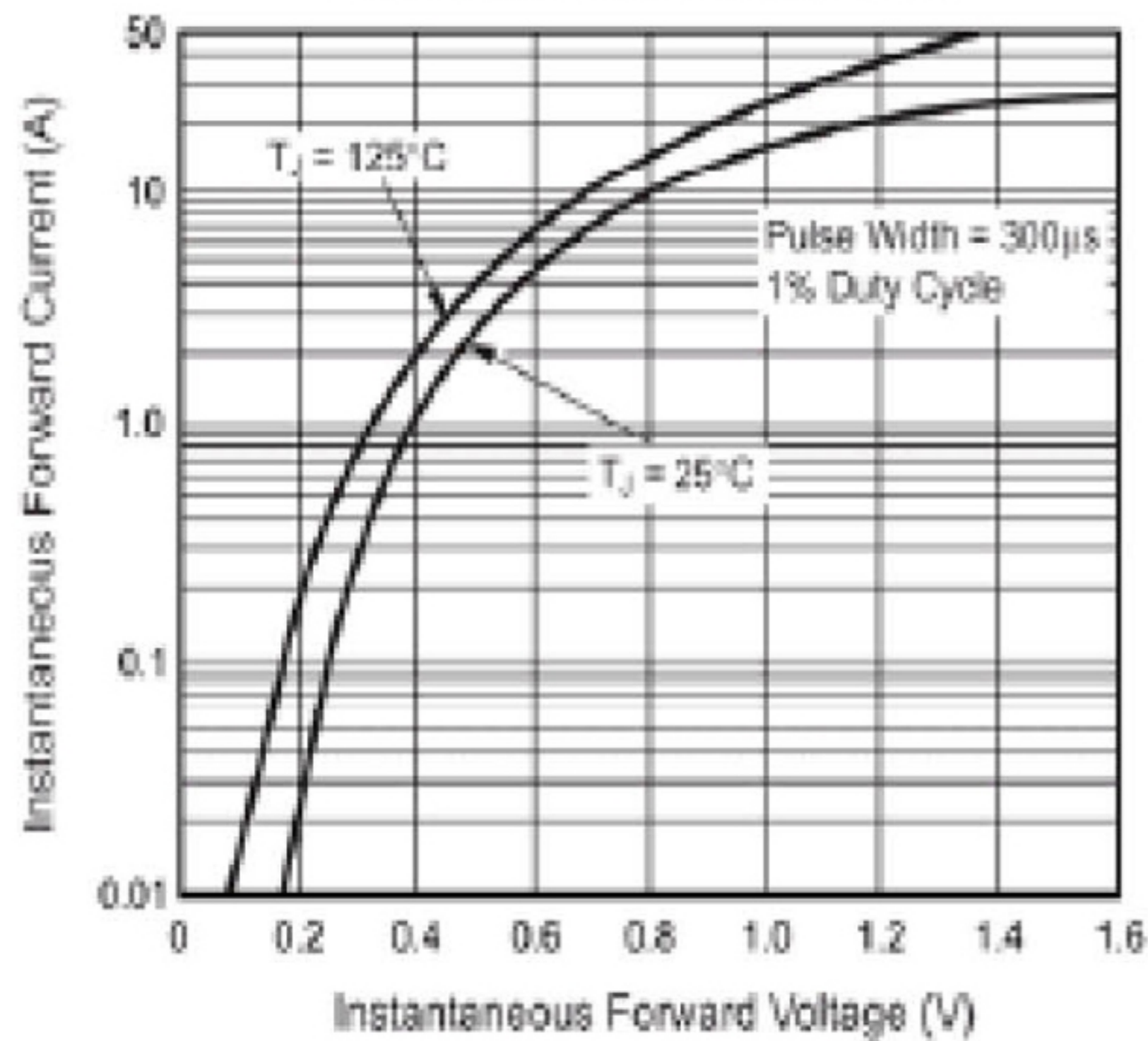

Fig. 4 - Typical Reverse Characteristics

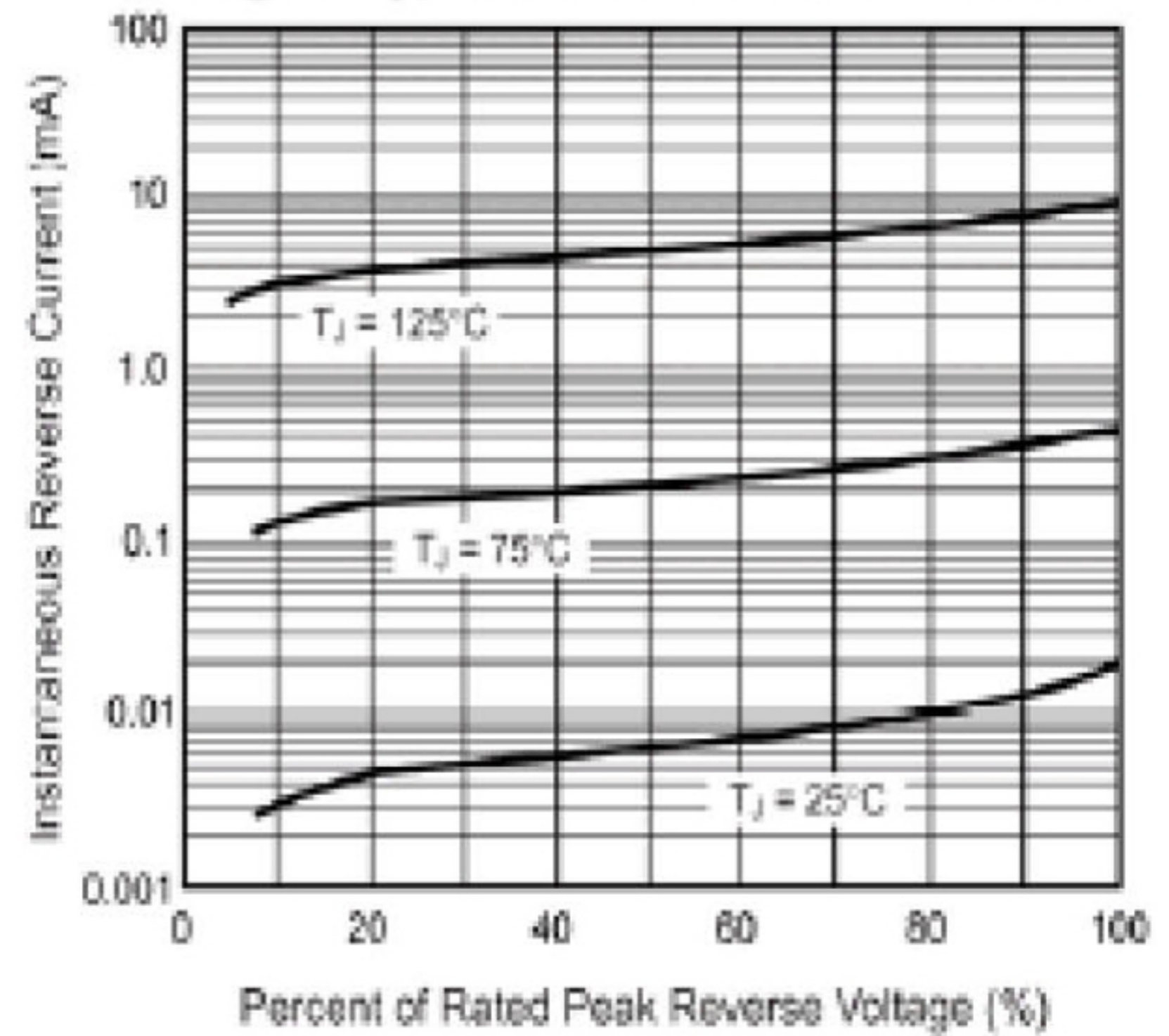

Fig. 5 - Typical Junction Capacitance

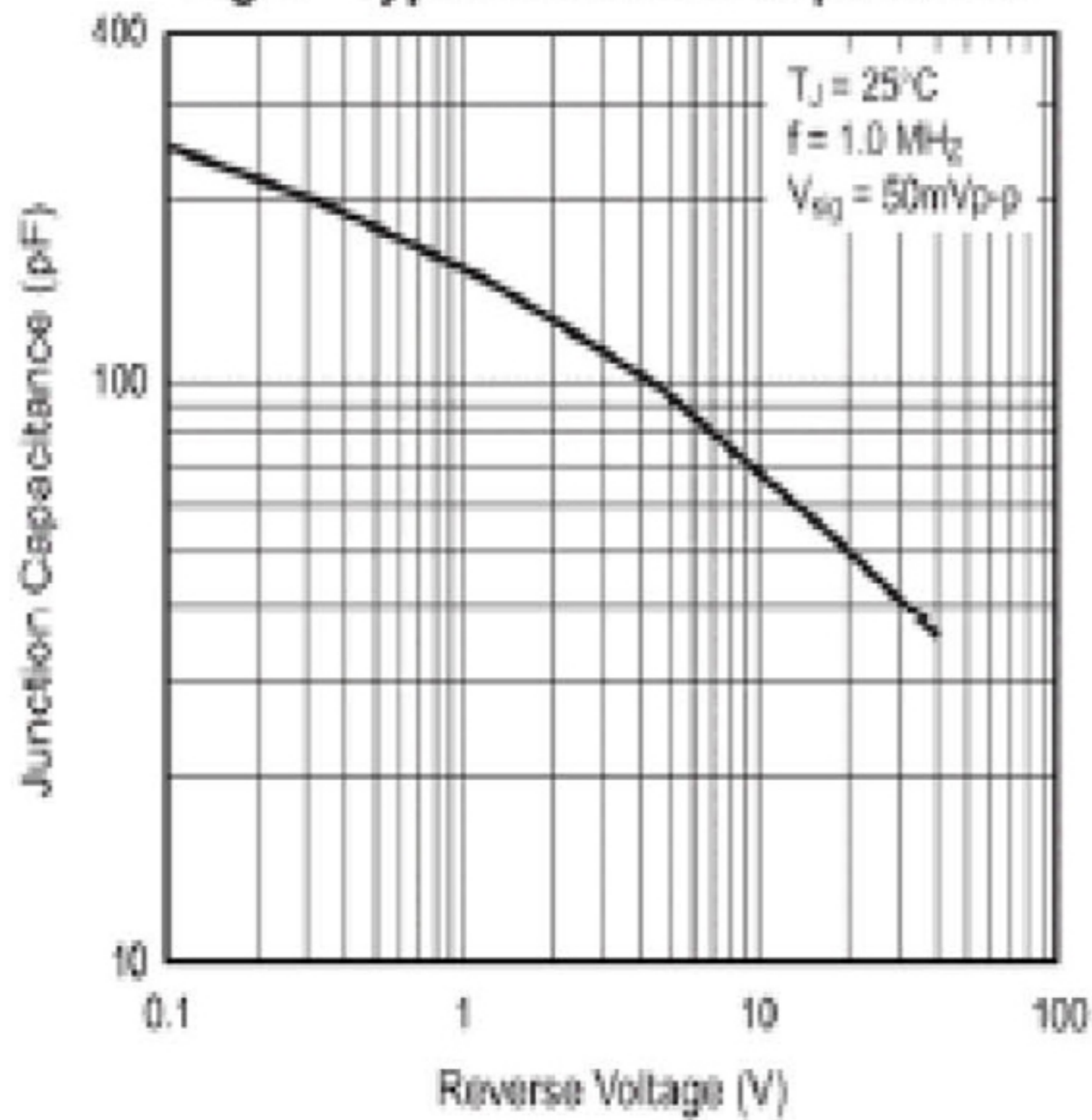
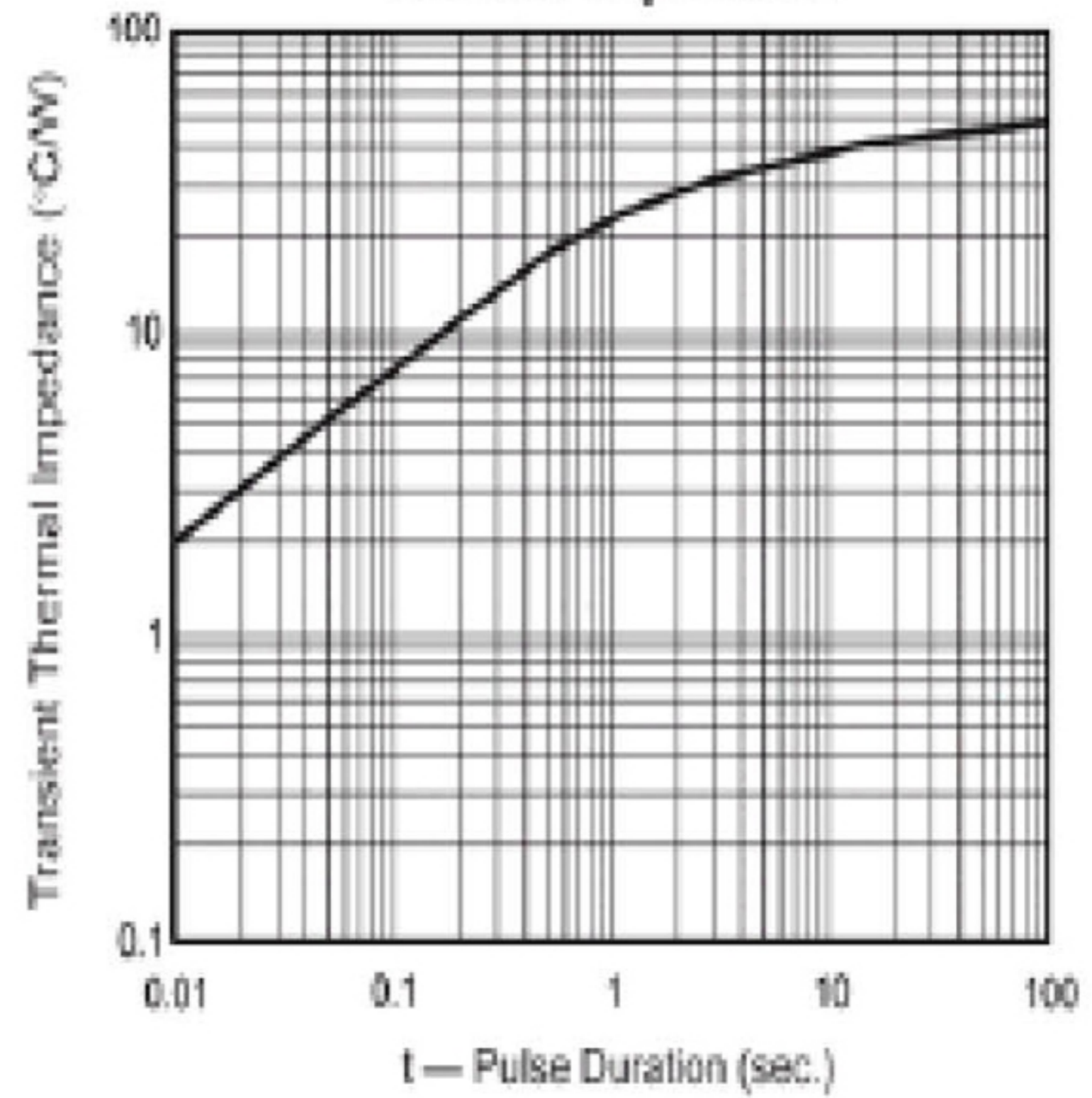
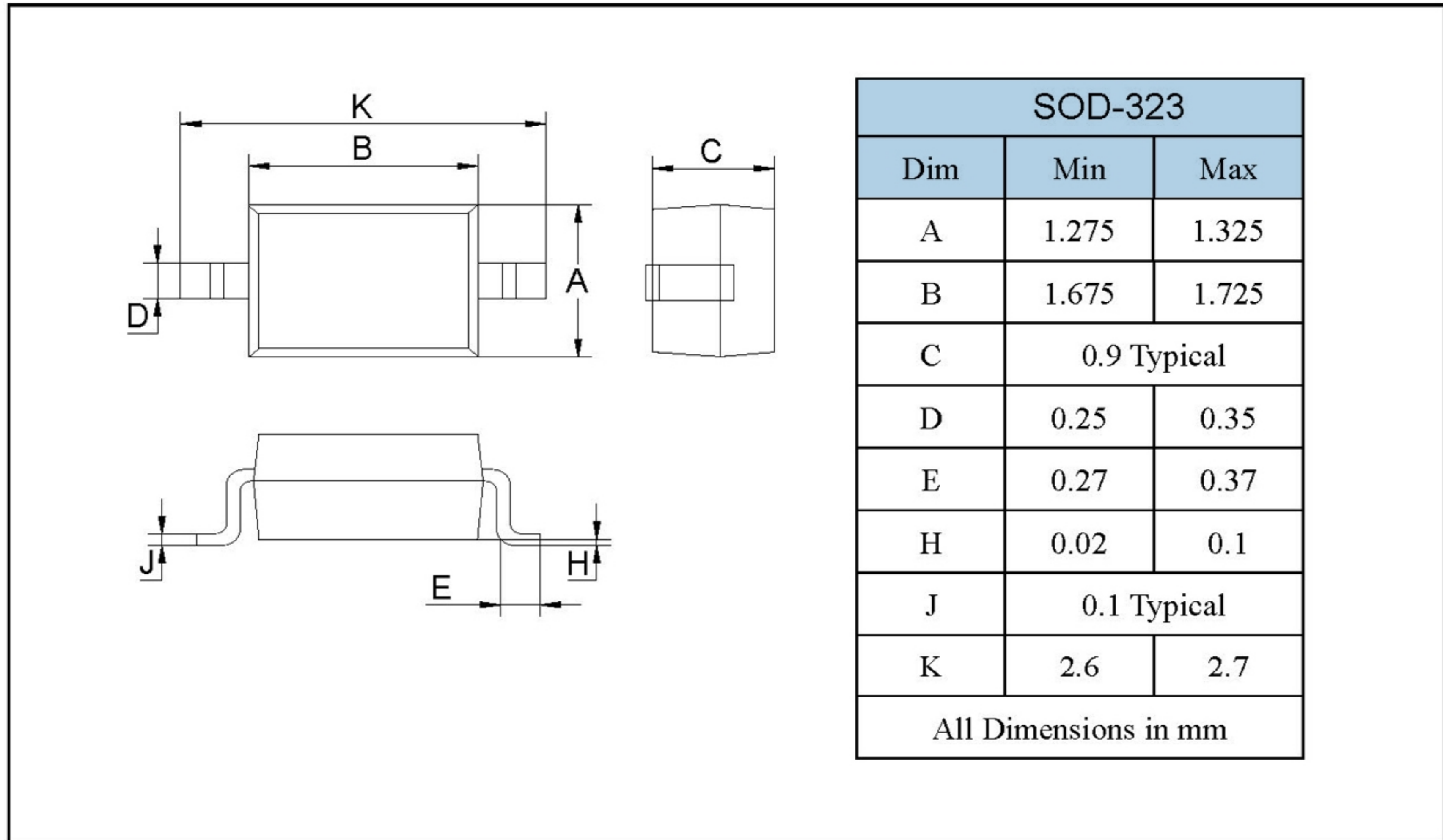

Fig. 6 - Typical Transient Thermal Impedance



PACKAGE OUTLINE

Plastic surface mounted package



SOLDERING FOOTPRINT

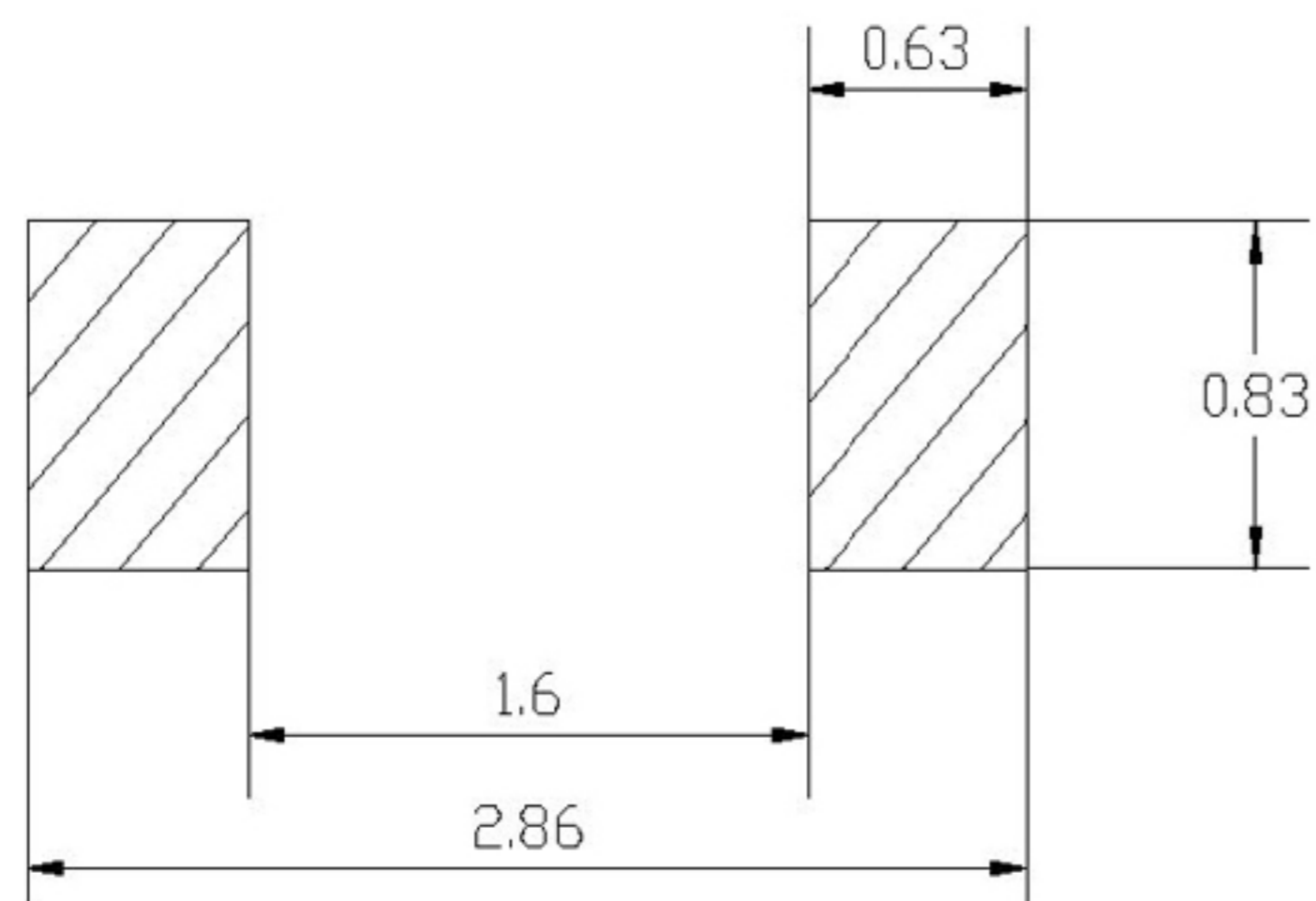

Unit : mm

PACKAGE INFORMATION

Device	Package	Shipping
B5817WS-B5819WS	SOD-323	3000/Tape&Reel