



Rated impedance 30 to 2000 Ω
Rated current 0,1 to 0,5 A



Construction

- Size 0603 to 1210 (EIA) or 1608 to 3225 (IEC)
- Multilayer technology with ferrite

Features

- Broadband attenuation
- Suitable for reflow (IR and vapor phase) and wave soldering

Applications

Prevention of high-frequency EMI in

- computers, printers
- VCRs, TVs
- cordless phones
- mobile phones

Terminals

- Tinned
- Ni intermediate layer

Marking

No marking on component

Minimum marking on reel:

Manufacturer, part number, ordering code,
Z value and tolerance of Z value,
quantity, date of packing

Delivery mode

8-mm blister tape wound on 178-mm \varnothing reel

For details on taping, packing and packing units [see page 234](#)

General technical data

Impedance $ Z $	Measured with HP 4291A at frequency f_z
Rated current I_R	Maximum dc current at ambient temperature $T_A = 85^\circ\text{C}$
DC resistance R_{\max}	Measured at 20°C ambient temperature
Climatic category	In accordance with IEC 60068-1 40/085/56 ($-40^\circ\text{C}/+85^\circ\text{C}/56$ days damp heat test)
Storage temperature	$-40^\circ\text{C}/+85^\circ\text{C}$
Soldering:	
Wave soldering	Maximum 260°C , 5 s
Infrared soldering	Maximum 250°C , 30 s temperature/time profile $> 215^\circ\text{C}$, max. 60 s
Vapor-phase soldering	Maximum $(215 \pm 5)^\circ\text{C}$, max. 60 s
Solderability	$(230 \pm 5)^\circ\text{C}$, $(4 \pm 1,0)$ s after preheating at 120 to 150°C , 60 s wetting of soldering area: $\geq 90\%$
Resistance to soldering heat	$(260 \pm 5)^\circ\text{C}$, $(10 \pm 0,5)$ s after preheating at 120 to 150°C , 60 s impedance change max. $\pm 75\%$
Permissible PCB bending	2 mm (100 mm long standard PCB)
Temperature cycles	$-40^\circ\text{C}/+85^\circ\text{C}$, for each 30 min., total 100 cycles impedance change $\leq 20\%$
Humidity test	40°C , 90 to 95 % r. h. at 200 mA, 1000 h impedance change $\leq 20\%$
Life test	1000 h at 85°C and 200 mA impedance change $\leq 20\%$

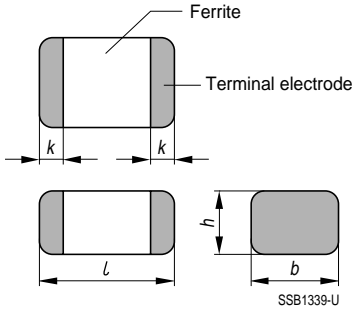
Dimensional drawing

Type	Size		Dimensions (mm)			
	EIA	IEC	<i>l</i>	<i>b</i>	<i>h</i>	<i>k</i>
B82482-B	0603	1608	1,6 ± 0,2	0,8 ± 0,15	0,8 ± 0,15	0,4 ± 0,2
B82483-B	0805	2012	2,0 ± 0,2	1,25 ± 0,2	0,9 ± 0,2	0,5 ± 0,3
B82485-B	1206	3216	3,2 ± 0,2	1,6 ± 0,2	1,1 ± 0,2	0,5 ± 0,3
B82486-B	1210	3225	3,2 ± 0,2	2,5 ± 0,2	1,3 ± 0,2	0,5 ± 0,3

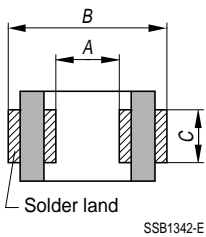
PCB layout recommendation

Type	Size		Dimensions (mm)		
	EIA	IEC	<i>A</i>	<i>B</i>	<i>C</i>
B82482-B	0603	1608	0,8	2,4 ... 3,4	0,6
B82483-B	0805	2012	1,2	3,0 ... 4,0	1,0
B82485-B	1206	3216	2,0	4,2 ... 5,2	1,2
B82486-B	1210	3225	2,0	4,2 ... 5,2	1,8

Characteristics and ordering codes

 For further technical data [see page 226](#).

Size EIA	IEC	$ Z $ Ω	Toler- ance	f_z MHz	I_R A	R_{max} Ω	Ordering code
0603	1608	30	$\pm 25\%$	100	0,2	0,2	B82482-B1300-A
		60		100	0,2	0,2	B82482-B1600-A
		80		100	0,2	0,3	B82482-B1800-A
		120		100	0,2	0,3	B82482-B1121-A
		300		100	0,1	0,6	B82482-B1301-A
0805	2012	32	$\pm 25\%$	100	0,5	0,2	B82483-B1320-A
		80		100	0,4	0,4	B82483-B1800-A
		120		100	0,2	0,4	B82483-B1121-A
		300		100	0,2	0,9	B82483-B1301-A
		600		100	0,2	1,0	B82483-B1601-A
		1000		100	0,1	1,0	B82483-B1102-A
1206	3216	32	$\pm 25\%$	100	0,5	0,15	B82485-B1320-A
		70		100	0,4	0,3	B82485-B1700-A
		90		100	0,4	0,3	B82485-B1900-A
		150		100	0,2	0,5	B82485-B1151-A
		600		100	0,2	0,5	B82485-B1601-A
		1200		50	0,1	1,0	B82485-B1122-A
1210	3225	90	$\pm 25\%$	100	0,4	0,3	B82486-B1900-A
		2000		30	0,1	1,5	B82486-B1202-A



Typical electrical characteristics

Impedance $|Z|$, real part R and imaginary part X versus frequency f

————— $|Z|$ - - - - - R - - - - - X

Size 0603

B82482-B1300-A

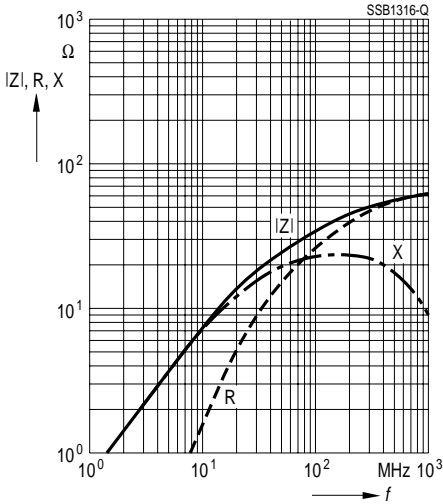

B82482-B1600-A

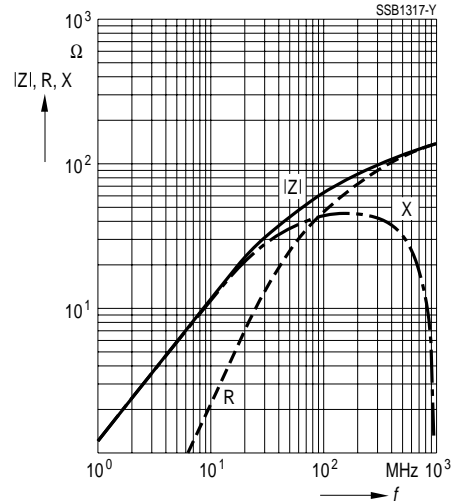

B82482-B1800-A

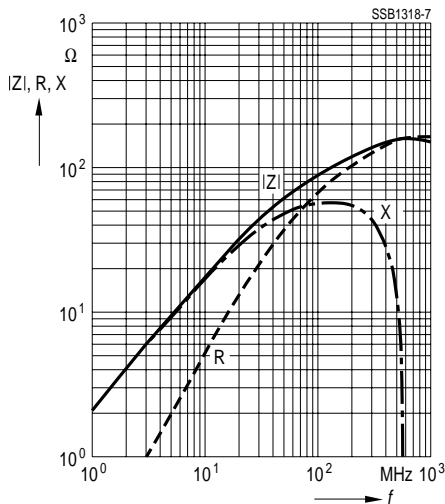

B82482-B1121-A

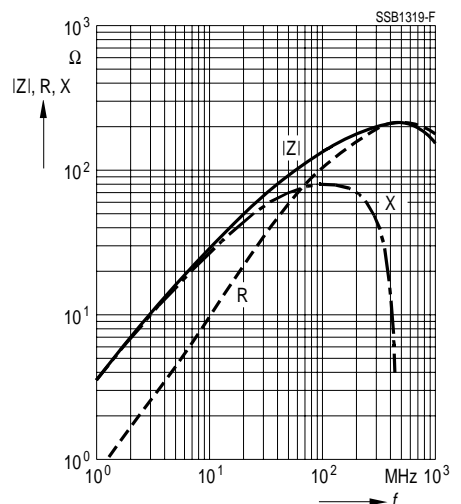



Typical electrical characteristics

Impedance $|Z|$, real part R and imaginary part X versus frequency f

————— $|Z|$ - - - - - R - - - - - X

Size 0603

B82482-B1301-A

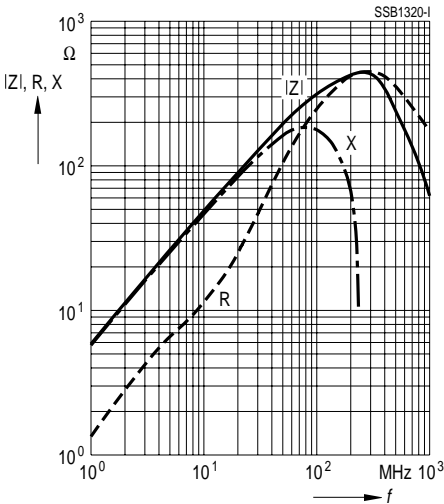

Size 0805

B82483-B1320-A

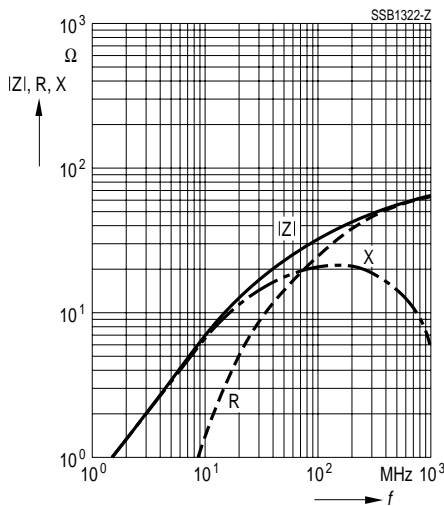

B82483-B1800-A

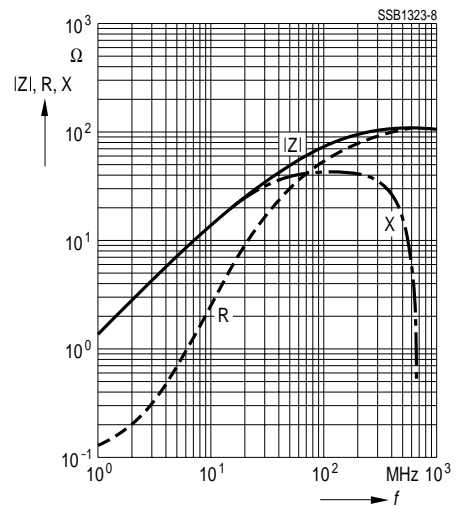



Typical electrical characteristics

Impedance $|Z|$, real part R and imaginary part X versus frequency f

————— $|Z|$ - - - - - R - - - - - X

Size 0805

B82483-B1121-A

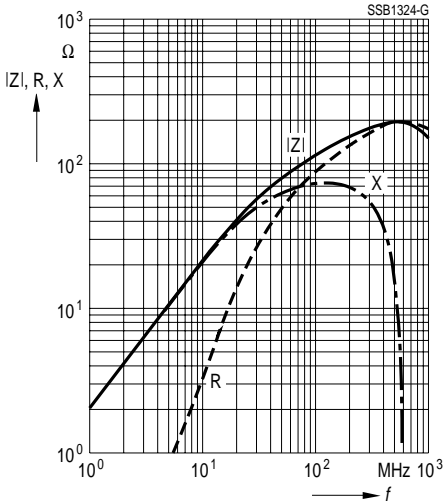

B82483-B1301-A

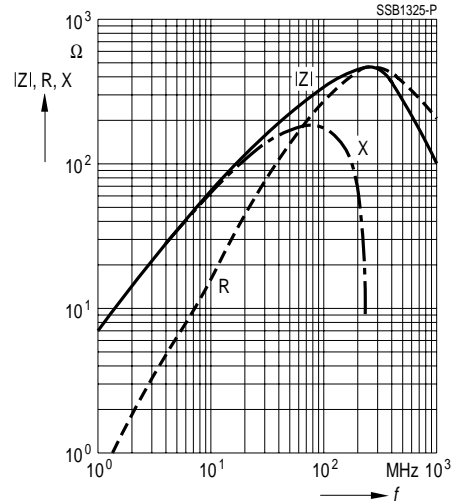

B82483-B1601-A

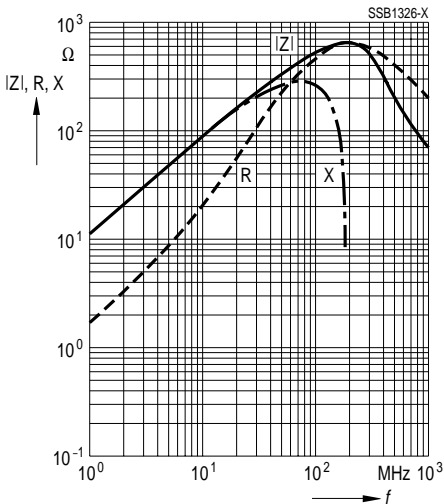

B82483-B1102-A

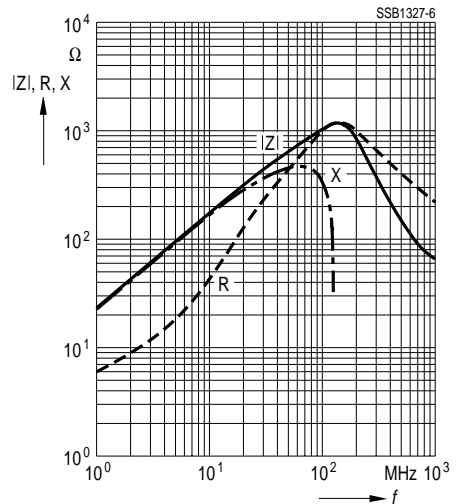



Typical electrical characteristics

Impedance $|Z|$, real part R and imaginary part X versus frequency f

————— $|Z|$ - - - - - R - - - - - X

Size 1206

B82485-B1320-A

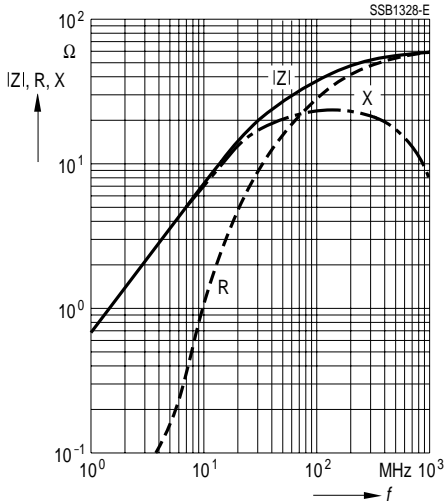

B82485-B1700-A

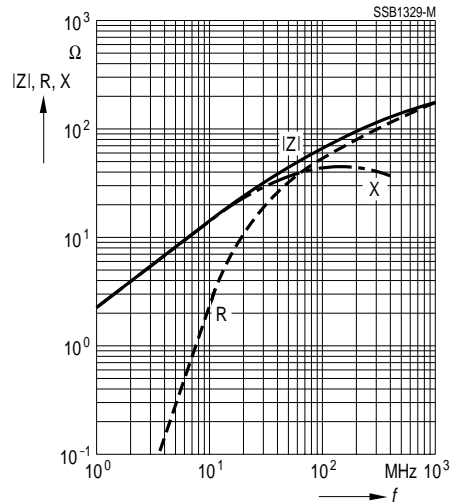

B82485-B1900-A

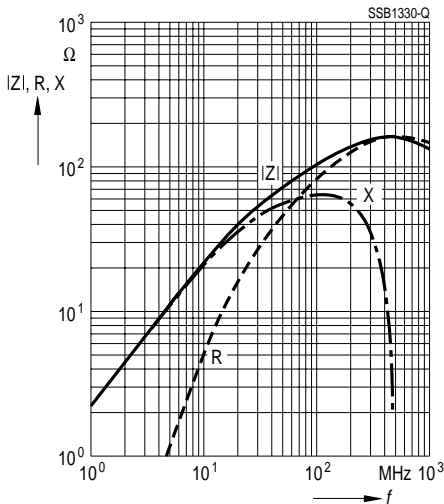

B82485-B1151-A

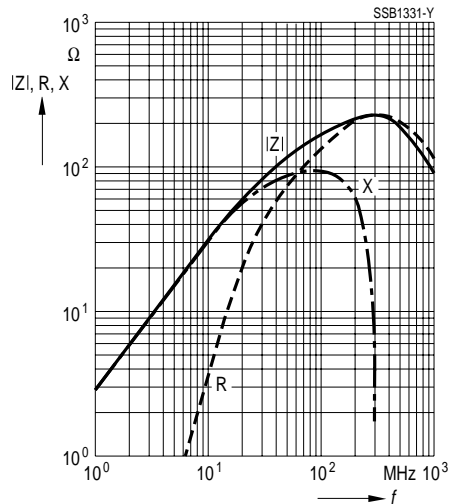



Typical electrical characteristics

Impedance $|Z|$, real part R and imaginary part X versus frequency f

————— $|Z|$ - - - - - R - - - - - X

Size 1206

B82485-B1601-A

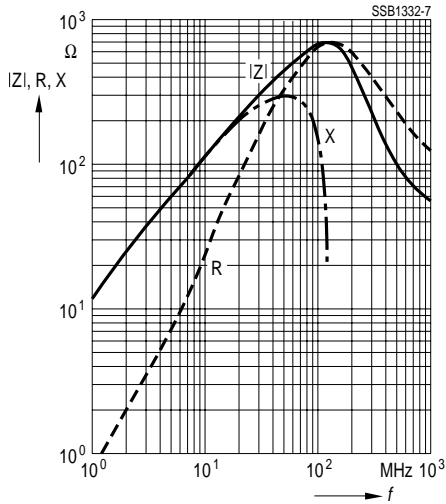

B82485-B1122-A

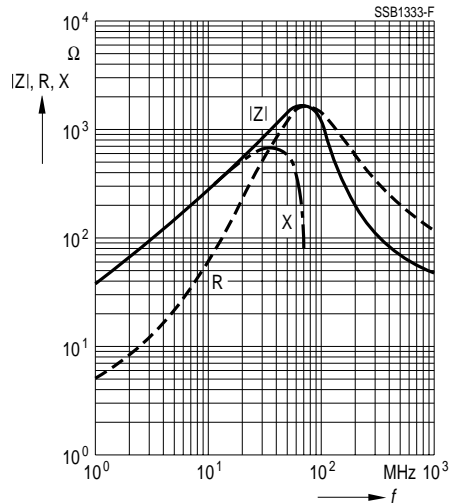

Size 1210

B82486-B1900-A

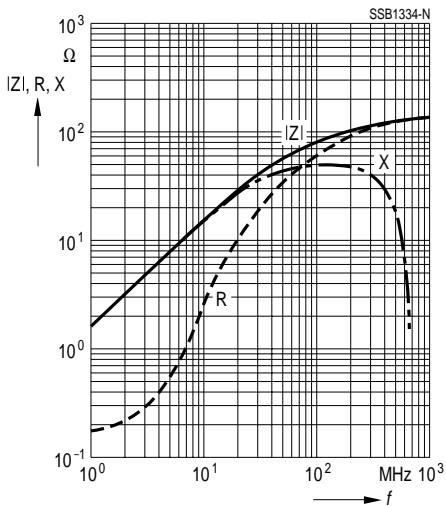

B82486-B1202-A

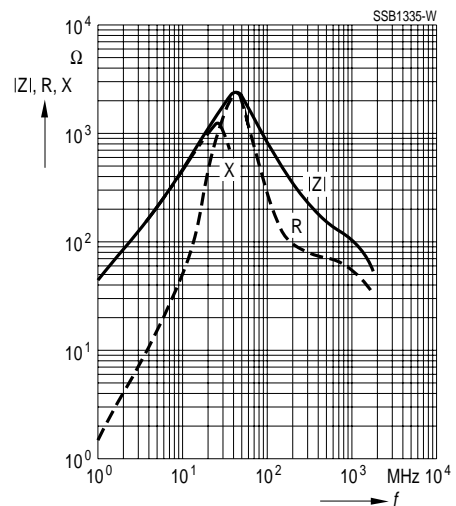

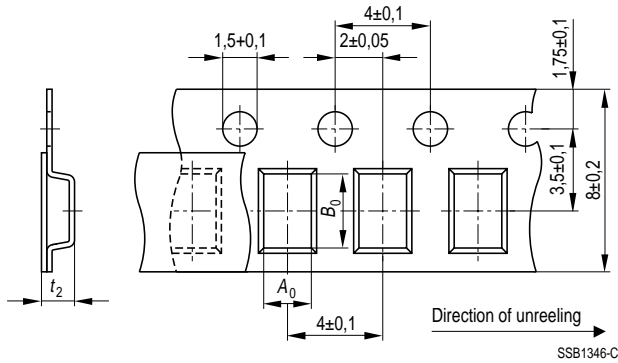
8-mm blister tape

Type	Size		Dimensions (mm)		
	EIA	IEC	A ₀	B ₀	t ₂ (max.)
B82482-B	0603	1608	1,14 ± 0,1	1,75 ± 0,1	1,3
B82483-B	0805	2012	1,54 ± 0,1	2,32 ± 0,1	1,3
B82485-B	1206	3216	1,94 ± 0,1	3,54 ± 0,1	1,6
B82486-B	1210	3225	2,80 ± 0,2	3,54 ± 0,2	1,9

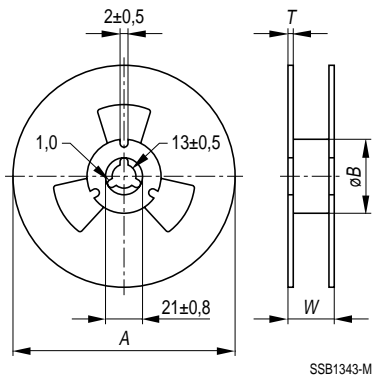
Reel packing

Type	Size		Dimensions (mm)				Packing unit Pieces/reel
	EIA	IEC	A	∅ B	W	T	
B82482-B	0603	1608	178 ± 2	60 ± 1	11 ± 1	1,2 ± 0,5	4000
B82483-B	0805	2012					4000
B82485-B	1206	3216					3000
B82486-B	1210	3225					2500