

Video signal switcher for AV amplifiers

BA7626 / BA7626F

The BA7626 and BA7626F are video signal switches that contain two five-channel analog multiplexers for switching chroma and audio signals, and two wide-band 6dB amplifiers. By simply adding transistor buffers to the outputs, it is possible to construct a record / playback switch for two record / playback VCRs, and three video playback machines (eg. laser desk players). Input switching and VCR record switching can be done independently. The inputs are terminated with 20k Ω resistors, and are suitable for switching chroma and audio signals.

●Applications

AV amplifiers (audio signals and S-pin chroma signals) and video selectors

●Features

- | | |
|----------------------------------|-----------------------------|
| 1) 5-input / 3-output switches. | 3) Built-in 6dB amplifiers. |
| 2) 20k Ω input impedance. | 4) 5V supply voltage. |

●Absolute maximum ratings (Ta = 25°C)

Parameter	Symbol	Limits	Unit
Power supply voltage	V _{cc}	9	V
Power dissipation	P _d	500*	mW
Operating temperature	T _{opr}	- 25 ~ +70	°C
Storage temperature	T _{stg}	- 55 ~ +125	°C

* Reduced by 5.0mW for each increase in Ta of 1°C over 25°C.

●Block diagram

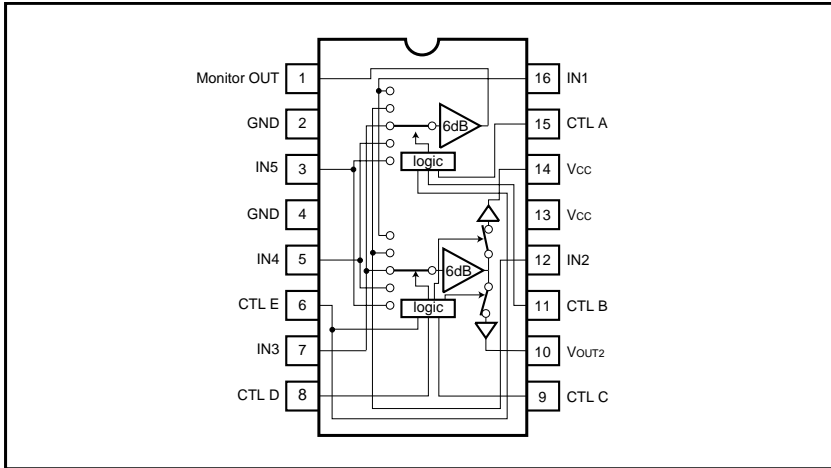

●Truth table

A	B	E	Monitor OUT
L	L	*	IN1
H	L	*	IN2
L	H	*	IN3
H	H	L	IN4
H	H	H	IN5

C	D	E	V _{OUT1}
L	L	*	—
H	L	*	IN2
L	H	*	IN3
H	H	L	IN4
H	H	H	IN5

C	D	E	V _{OUT2}
L	L	*	IN1
H	L	*	—
L	H	*	IN3
H	H	L	IN4
H	H	H	IN5

Note 1: * indicates "don't care" (H or L).

●Equivalent input / output circuits (unless otherwise noted, $T_a=25^\circ\text{C}$ and $V_{CC} = 5\text{V}$)

Pin No.	Pin name	Standard voltage (no input signal)	Equivalent input / output circuit
3 5 7 12 16	IN5 IN4 IN3 IN2 IN1	3.6V	
6 8 9 11 15	CTL E CTL D CTL C CTL B CTL A	0.6V	
1	MONOUT	2.0V	
10 14	Vout2 Vout1	2.0V	

●Electrical characteristics (unless otherwise noted, Ta = 25°C and Vcc = 5V)

Parameter	Symbol	Min.	Typ.	Max.	Unit	Conditions
Operating voltage	V _{cc}	4.5	5.0	5.5	V	—
Supply current	I _{cc}	—	15.0	20.0	mA	—
Maximum output level	V _{om}	2.3	2.5	—	V _{P-P}	f = 1kHz, THD = 0.5%
Voltage gain	G _v	5.7	6.2	6.7	dB	f = 1MHz, V _{IN} = 1V _{P-P}
Interchannel crosstalk	C _T	—	-65	-45	dB	f = 4.43MHz, V _{IN} = 1V _{P-P}
Mute level	CTM	—	-35	-25	dB	f = 4.43MHz, V _{IN} = 1V _{P-P}
Frequency characteristic	G _f	-3	0	3	dB	10MHz / 1MHz, V _{IN} = 1V _{P-P}
Input impedance	Z _{IN}	16	20	24	kΩ	—
CTL pin switch level	V _{TH}	2.2	—	3.3	V	—

○Not designed for radiation resistance.

●Measurement circuit

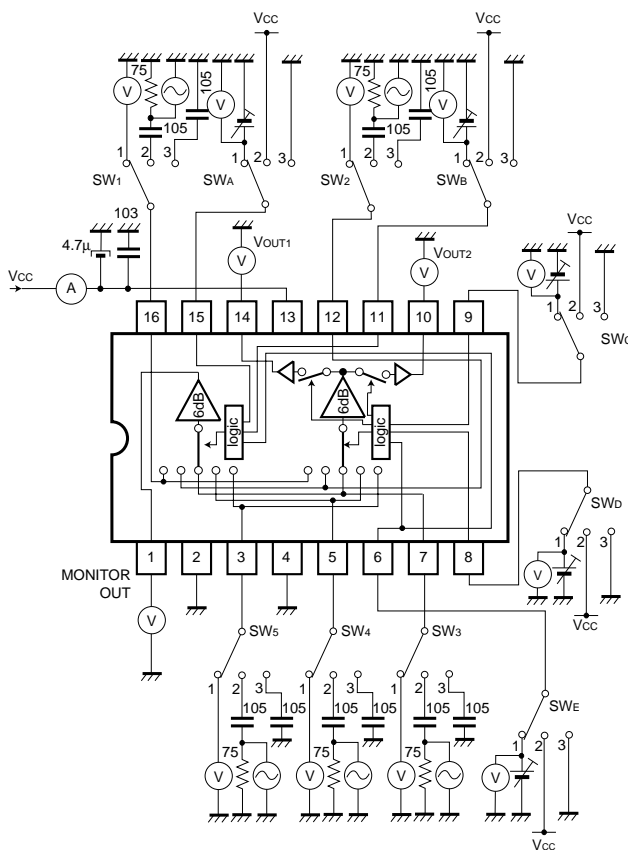

●Measurement conditions

Parameter	Symbol	Switch settings										Measurement method
		SW ₁	SW ₂	SW ₃	SW ₄	SW ₅	SW _A	SW _B	SW _C	SW _D	SW _E	
Current dissipation	I _{CC}	3	3	3	3	3	2	2	2	2	2	—
Monitor OUT maximum output level	V _{om} 1MON	2	3	3	3	3	3	3	*	*	*	Note 1
	V _{om} 2MON	3	2	↓	↓	↓	2	3	↓	↓	↓	
	V _{om} 3MON	↓	3	2	↓	↓	3	2	↓	↓	↓	
	V _{om} 4MON	↓	↓	3	2	↓	2	2	↓	↓	3	
	V _{om} 5MON	↓	↓	↓	3	2	2	2	↓	↓	2	
Voltage gain	G _v 1MON	2	3	3	3	3	3	3	*	*	*	Note 2
	G _v 2MON	3	2	↓	↓	↓	2	3	↓	↓	↓	
	G _v 3MON	↓	3	2	↓	↓	3	2	↓	↓	↓	
	G _v 4MON	↓	↓	3	2	↓	2	2	↓	↓	3	
	G _v 5MON	↓	↓	↓	3	2	2	2	↓	↓	2	
Monitor OUT interchannel crosstalk	C _{r1} - 2MON	2	3	3	3	3	2	3	*	*	*	Note 3
	C _{r1} - 3MON	↓	↓	↓	↓	↓	3	2	↓	↓	↓	
	C _{r1} - 4MON	↓	↓	↓	↓	↓	2	2	↓	↓	3	
	C _{r1} - 5MON	↓	↓	↓	↓	↓	2	2	↓	↓	2	
	C _{r2} - 1MON	3	2	3	3	3	3	3	*	*	*	
	C _{r2} - 3MON	↓	↓	↓	↓	↓	3	2	↓	↓	↓	
	C _{r2} - 4MON	↓	↓	↓	↓	↓	2	2	↓	↓	3	
	C _{r2} - 5MON	↓	↓	↓	↓	↓	2	2	↓	↓	2	
	C _{r3} - 1MON	3	3	2	3	3	3	3	*	*	*	
	C _{r3} - 2MON	↓	↓	↓	↓	↓	2	3	↓	↓	↓	
	C _{r3} - 4MON	↓	↓	↓	↓	↓	2	2	↓	↓	3	
	C _{r3} - 5MON	↓	↓	↓	↓	↓	2	2	↓	↓	2	
	C _{r4} - 1MON	3	3	3	2	3	3	3	*	*	*	
	C _{r4} - 2MON	↓	↓	↓	↓	↓	2	3	↓	↓	↓	
	C _{r4} - 3MON	↓	↓	↓	↓	↓	2	2	↓	↓	↓	
	C _{r4} - 5MON	↓	↓	↓	↓	↓	2	2	↓	↓	3	
	C _{r5} - 1MON	3	3	3	3	2	3	3	*	*	*	
	C _{r5} - 2MON	↓	↓	↓	↓	↓	2	3	↓	↓	↓	
	C _{r5} - 3MON	↓	↓	↓	↓	↓	2	2	↓	↓	↓	
	C _{r5} - 4MON	↓	↓	↓	↓	↓	2	2	↓	↓	2	
Monitor OUT frequency characteristic	G _f 1MON	2	3	3	3	3	3	3	*	*	*	Note 4
	G _f 2MON	3	2	↓	↓	↓	2	3	↓	↓	↓	
	G _f 3MON	↓	3	2	↓	↓	3	2	↓	↓	↓	
	G _f 4MON	↓	↓	3	2	↓	2	2	↓	↓	3	
	G _f 5MON	↓	↓	↓	3	2	2	2	↓	↓	2	
V _{OUT1} maximum output level	V _{om} 2OUT1	3	2	3	3	3	*	*	2	3	*	Note 1
	V _{om} 3OUT1	↓	3	2	↓	↓	↓	3	2	2	↓	
	V _{om} 4OUT1	↓	↓	3	2	3	↓	↓	2	2	3	
	V _{om} 5OUT1	↓	↓	↓	3	2	↓	↓	2	2	2	

●Measurement conditions

Parameter	Symbol	Switch settings										Measurement method
		SW ₁	SW ₂	SW ₃	SW ₄	SW ₅	SW _A	SW _B	SW _C	SW _D	SW _E	
V _{OUT1} voltage gain	G _V 2OUT1	3	2	3	3	3	*	*	2	3	*	Note 2
	G _V 3OUT1	↓	3	2	↓	↓	↓	↓	3	2	↓	
	G _V 4OUT1	↓	↓	3	2	3	↓	↓	2	2	3	
	G _V 5OUT1	↓	↓	↓	3	2	↓	↓	2	2	2	
V _{OUT1} interchannel crosstalk	C _{T1} - 2OUT1	2	3	3	3	3	*	*	3	3	*	Note 3
	C _{T1} - 3OUT1	↓	↓	↓	↓	↓	↓	↓	3	2	↓	
	C _{T1} - 4OUT1	↓	↓	↓	↓	↓	↓	↓	2	2	3	
	C _{T1} - 5OUT1	↓	↓	↓	↓	↓	↓	↓	2	2	2	
	C _{T2} - 1OUT1	3	2	3	3	3	*	*	3	3	*	
	C _{T2} - 3OUT1	↓	↓	↓	↓	↓	↓	↓	3	2	↓	
	C _{T2} - 4OUT1	↓	↓	↓	↓	↓	↓	↓	2	2	3	
	C _{T2} - 5OUT1	↓	↓	↓	↓	↓	↓	↓	2	2	2	
	C _{T3} - 1OUT1	3	3	2	3	3	*	*	3	3	*	
	C _{T3} - 2OUT1	↓	↓	↓	↓	↓	↓	↓	2	3	↓	
	C _{T3} - 4OUT1	↓	↓	↓	↓	↓	↓	↓	2	2	3	
	C _{T3} - 5OUT1	↓	↓	↓	↓	↓	↓	↓	2	2	2	
	C _{T4} - 1OUT1	3	3	3	2	3	*	*	3	3	*	
	C _{T4} - 2OUT1	↓	↓	↓	↓	↓	↓	↓	2	3	↓	
	C _{T4} - 3OUT1	↓	↓	↓	↓	↓	↓	↓	3	2	↓	
	C _{T4} - 5OUT1	↓	↓	↓	↓	↓	↓	↓	2	2	2	
	C _{T5} - 1OUT1	3	3	3	3	2	*	*	3	3	*	
	C _{T5} - 2OUT1	↓	↓	↓	↓	↓	↓	↓	2	3	↓	
	C _{T5} - 3OUT1	↓	↓	↓	↓	↓	↓	↓	3	2	↓	
	C _{T5} - 4OUT1	↓	↓	↓	↓	↓	↓	↓	2	2	3	
V _{OUT1} frequency characteristic	G _f 2OUT1	3	2	3	3	3	*	*	2	3	*	Note 4
	G _f 3OUT1	↓	3	2	↓	↓	↓	↓	3	2	↓	
	G _f 4OUT1	↓	↓	3	2	↓	↓	↓	2	2	3	
	G _f 5OUT1	↓	↓	↓	3	2	↓	↓	2	2	2	
V _{OUT2} maximum output level	V _{om} 1OUT2	2	3	3	3	3	*	*	3	3	*	Note 1
	V _{om} 3OUT2	3	2	↓	↓	↓	↓	↓	3	2	↓	
	V _{om} 4OUT2	↓	3	↓	2	↓	↓	↓	2	2	3	
	V _{om} 5OUT2	↓	↓	↓	3	2	↓	↓	2	2	2	
V _{OUT2} voltage gain	G _V 1OUT2	2	3	3	3	3	*	*	3	3	*	Note 2
	G _V 3OUT2	3	2	↓	↓	↓	↓	↓	3	2	↓	
	G _V 4OUT2	↓	3	↓	2	↓	↓	↓	2	2	3	
	G _V 5OUT2	↓	↓	↓	3	2	↓	↓	2	2	2	

Parameter	Symbol	Switch settings										Measurement method
		SW ₁	SW ₂	SW ₃	SW ₄	SW ₅	SW _A	SW _B	SW _C	SW _D	SW _E	
V _{OUT2} interchannel crosstalk	C _{T1} - 2OUT2	2	3	3	3	3	*	*	2	3	*	Note 3
	C _{T1} - 3OUT2	↓	↓	↓	↓	↓	↓	↓	3	2	↓	
	C _{T1} - 4OUT2	↓	↓	↓	↓	↓	↓	↓	2	2	3	
	C _{T1} - 5OUT2	↓	↓	↓	↓	↓	↓	↓	2	2	2	
	C _{T2} - 1OUT2	3	2	3	3	3	*	*	3	3	*	
	C _{T2} - 3OUT2	↓	↓	↓	↓	↓	↓	↓	3	2	↓	
	C _{T2} - 4OUT2	↓	↓	↓	↓	↓	↓	↓	2	2	3	
	C _{T2} - 5OUT2	↓	↓	↓	↓	↓	↓	↓	2	2	2	
	C _{T3} - 1OUT2	3	3	2	3	3	*	*	3	3	*	
	C _{T3} - 2OUT2	↓	↓	↓	↓	↓	↓	↓	2	3	↓	
	C _{T3} - 4OUT2	↓	↓	↓	↓	↓	↓	↓	2	2	3	
	C _{T3} - 5OUT2	↓	↓	↓	↓	↓	↓	↓	2	2	2	
	C _{T4} - 1OUT2	3	3	3	2	3	*	*	3	3	*	
	C _{T4} - 2OUT2	↓	↓	↓	↓	↓	↓	↓	2	3	↓	
	C _{T4} - 3OUT2	↓	↓	↓	↓	↓	↓	↓	3	2	↓	
	C _{T4} - 5OUT2	↓	↓	↓	↓	↓	↓	↓	2	2	2	
	C _{T5} - 1OUT2	3	3	3	3	2	*	*	3	3	*	
	C _{T5} - 2OUT2	↓	↓	↓	↓	↓	↓	↓	2	3	↓	
	C _{T5} - 3OUT2	↓	↓	↓	↓	↓	↓	↓	3	2	↓	
	C _{T5} - 4OUT2	↓	↓	↓	↓	↓	↓	↓	2	2	3	
V _{OUT2} frequency characteristic	G _f 1OUT1	2	3	3	3	3	*	*	3	3	*	Note 4
	G _f 3OUT1	3	3	2	↓	↓	↓	↓	3	2	↓	
	G _f 4OUT1	↓	↓	3	2	↓	↓	↓	2	2	3	
	G _f 5OUT1	↓	↓	↓	3	2	↓	↓	2	2	2	
Mute level	CTM V _{OUT1}	2	3	3	3	3	*	*	3	3	*	Note 5
	CTM V _{OUT2}	↓	↓	↓	↓	↓	↓	↓	2	↓	↓	
CTL pin switching level	V _{THA}	2	3	3	3	3	1	3	*	*	*	Note 6
	V _{THB}	3	↓	2	↓	↓	3	1	↓	↓	↓	
	V _{THC}	2	↓	3	↓	↓	*	*	1	3	↓	
	V _{THD}	3	↓	2	↓	↓	↓	↓	3	1	↓	
	V _{THE}	↓	↓	3	2	↓	2	2	*	*	1	

Note 1: Connect a distortion meter to the output, and input a $f = 1\text{kHz}$ sine wave. Adjust the input level until the output distortion is 0.5%.

This output voltage at this time is the maximum output level V_{om} (VP-P).

Note 2: Input a 1VP-P, 1MHz sine wave. The voltage gain (in dB) is given by $G_v = 20 \log (V_{OUT} / V_{IN})$.

Note 3: Input a 1VP-P, 4.43MHz sine wave. The interchannel crosstalk (in dB) is given by $C_T = 20 \log (V_{OUT} / V_{IN}) + 6$.

Note 4: Input 1VP-P, 1MHz and 10MHz sine waves. The frequency characteristic (in dB) is given by $G_f = 20 \log (V_{OUT}(f = 10\text{MHz}) / V_{OUT}(f = 1\text{MHz}))$.

Note 5: Input a 1VP-P, 4.43MHz sine wave. The mute level is given by $CTM = 20 \log (V_{OUT} / V_{IN}) + 6$ (dB)

Note 6: Input a 1VP-P, 1MHz sine wave. Reduce the CTL pin voltage from V_{cc} . The CTL pin switching level (V_{TH}) is the CTL pin voltage at which the V_{out} level drops below 10mVP-P.

●Application example

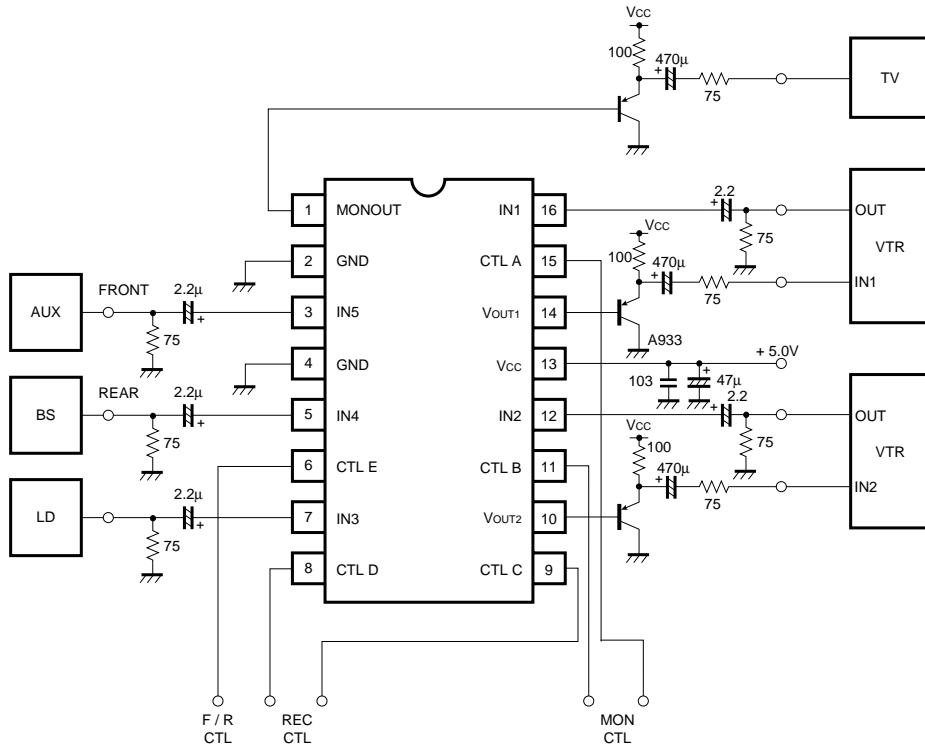

●External dimensions (Units: mm)

