

## Surface mount schottky barrier diode

## BAS70L

### FEATURES

- Low turn-on voltage.
- Fast switching.
- PN Junction guard ring for transient and
- Ultra-small surface mount package.
- Also available in lead free version.



Lead-free

### APPLICATIONS

- High speed switching applications.
- Circuit protecting.
- Voltage clamping.

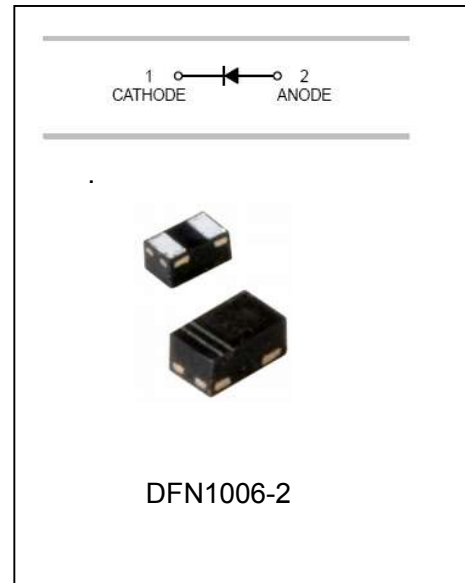

### ORDERING INFORMATION

Type No.	Marking	Package Code
BAS70L	73	DFN1006-2

### MAXIMUM RATING @ Ta=25°C unless otherwise specified

Characteristic	Symbol	Limits	Unit
Peak Repetitive Reverse Voltage	$V_{RRM}$		
Working Peak Reverse Voltage	$V_{RWM}$	70	V
DC Reverse Voltage	$V_R$		
RMS Reverse voltage	$V_{R(RMS)}$	49	V
Forward Continuous Current	$I_F$	70	mA
Non-Repetitive Peak Forward Surge Current @ $t_p < 1.0s$	$I_{FSM}$	100	mA
Power Dissipation	$P_d$	200	mW
Thermal Resistance, Junction to Ambient Air	$R_{\theta JA}$	625	°C/W
Operating Junction Temperature Range	$T_j$	-55 to +125	°C
Storage Temperature Range	$T_{STG}$	-65 to +150	°C

Surface mount schottky barrier diode

**BAS70L**

ELECTRICAL CHARACTERISTICS @ Ta=25°C unless otherwise specified

Characteristic	Symbol	Min	MAX	UNIT	Test Condition
Reverse Breakdown Voltage	$V_{(BR)R}$	70	-	V	$I_{(BR)} = 10\mu A$
Forward Voltage	$V_F$	-	410 1000	mV	$t_P < 300\mu s, I_F = 1.0mA$ $t_P < 300\mu s, I_F = 15mA$
Reverse Leakage Current	$I_R$	-	100	nA	$t_P < 300\mu s, V_R = 50V$
Junction Capacitance	$C_j$	-	2.0	pF	$V_R = 0V, f = 1.0MHz$
Reverse Recovery Time	$t_{rr}$	-	5.0	ns	$I_F = I_R = 10mA$ to $I_R = 1.0mA, R_L = 100\Omega$

TYPICAL CHARACTERISTICS @ Ta=25°C unless otherwise specified

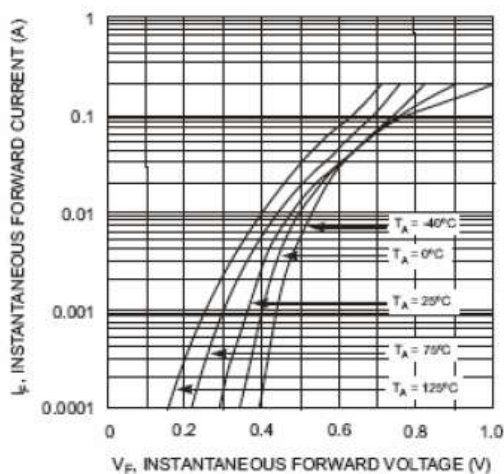

Fig. 1 Typical Forward Voltage

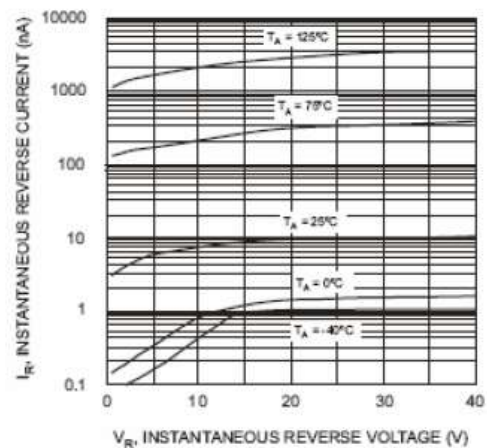

Fig. 2 Typical Reverse Characteristics

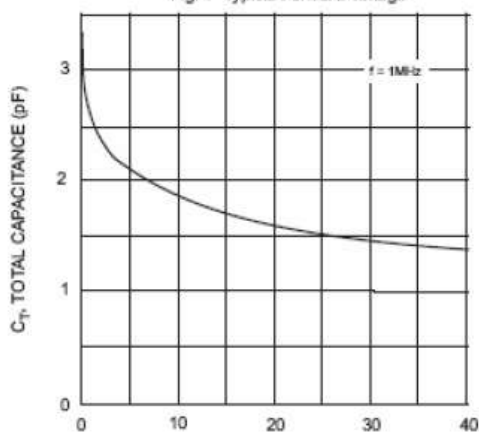

Fig. 3 Typical Capacitance

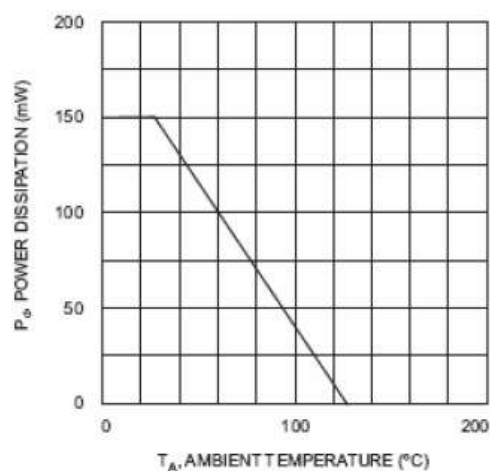

Fig. 4 Power Derating Curve, Total Package

Surface mount schottky barrier diode

**BAS70L**

PACKAGE OUTLINE

Plastic surface mounted package

DFN1006-2

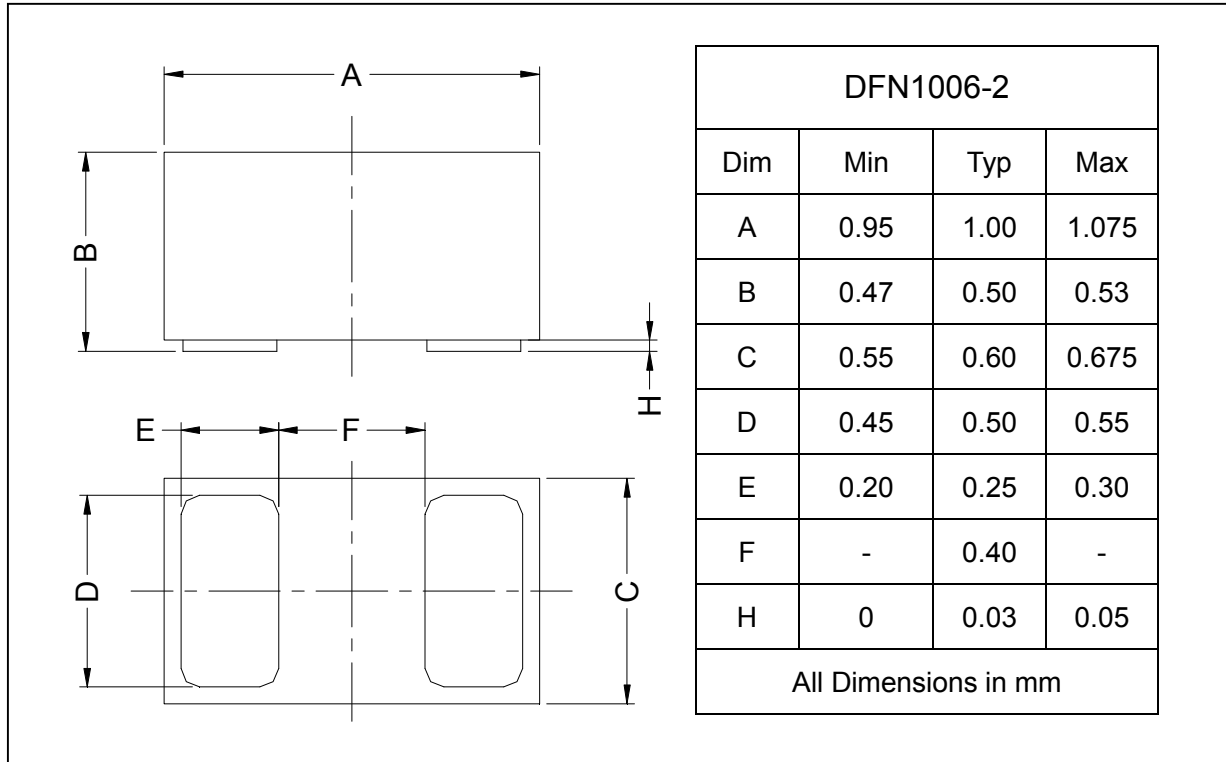

SOLDERING FOOTPRINT

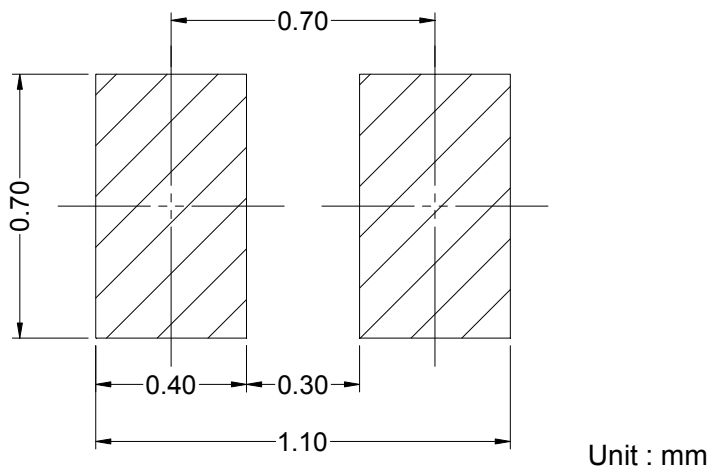

PACKAGE INFORMATION

Device	Package	Shipping
BAS70L	DFN1006-2	5000/Tape&Reel