

Small Signal Diode



Features

- ◇ Fast switching speed
- ◇ Surface device type mounting
- ◇ Moisture sensitivity level 1
- ◇ Matte Tin(Sn) lead finish with Nickel(Ni) underplate
- ◇ Pb free version and RoHS compliant
- ◇ Green compound (Halogen free) with suffix "G" on packing code and prefix "G" on date code

Mechanical Data

- ◇ Case :SOT-23 small outline plastic package
- ◇ Terminal: Matte tin plated, lead free., solderable per MIL-STD-202, Method 208 guaranteed
- ◇ High temperature soldering guaranteed: 260°C/10s
- ◇ Weight : 0.008gram (approximately)
- ◇ Marking Code : KL1,KL2,KL3,KL4

Pin Configuration

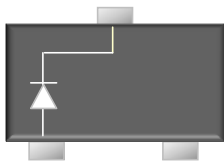

BAT54

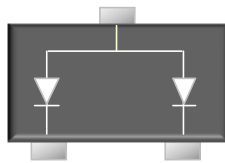

BAT54A

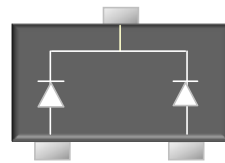

BAT54C

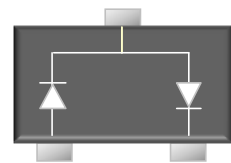

BAT54S

Ordering Information

Package	Part No.	Packing	Marking
SOT-23	BAT54 RF	3K / 7" Reel	KL1
SOT-23	BAT54A RF	3K / 7" Reel	KL2
SOT-23	BAT54C RF	3K / 7" Reel	KL3
SOT-23	BAT54S RF	3K / 7" Reel	KL4
SOT-23	BAT54 RFG	3K / 7" Reel	KL1
SOT-23	BAT54A RFG	3K / 7" Reel	KL2
SOT-23	BAT54C RFG	3K / 7" Reel	KL3
SOT-23	BAT54S RFG	3K / 7" Reel	KL4

Maximum Ratings and Electrical Characteristics

Rating at 25°C ambient temperature unless otherwise specified.

Maximum Ratings

Type Number	Symbol	Value	Units
Peak Repetitive Peak reverse voltage	V_{RRM}	30	V
Working Peak Reverse Voltage	V_{RWM}		
DC Reverse Voltage	V_R		
Forward Continuous Current	I_F	200	mA
Repetitive Peak Forward Current	I_{FRM}	200	mA
Forward surge current @t<1.0s	I_{FSM}	600	mA
Power Dissipation	P_d	200	mW
Thermal resistance, junction to ambient air	$R_{\theta JA}$	500	°C/W
Operating and Storage temperature	T_j, T_{STG}	-55 to 150	°C

SOT-23

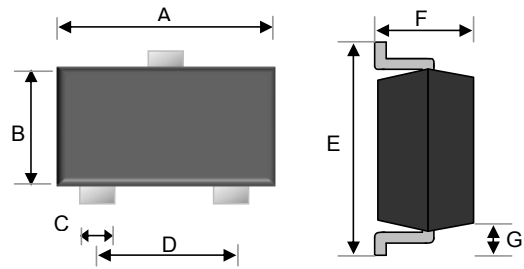

Dimensions	Unit (mm)		Unit (inch)	
	Min	Max	Min	Max
A	2.80	3.00	0.110	0.118
B	1.20	1.40	0.047	0.055
C	0.30	0.50	0.012	0.020
D	1.80	2.00	0.071	0.079
E	2.25	2.55	0.089	0.100
F	0.90	1.20	0.035	0.043
G	0.550 REF		0.022 REF	

Suggested PAD Layout

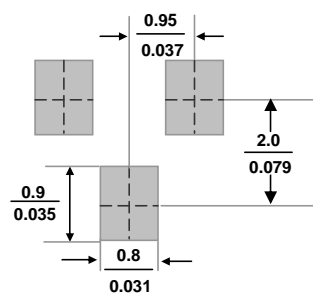

Small Signal Diode

Electrical Characteristics

Type Number		Symbol	Min	Max	Units
Reverse Breakdown Voltage	$I_R = 100\mu A$	$V_{(BR)}$	30	--	V
Forward Voltage	$I_F = 0.1mA$	V_F	--	0.24	V
	$I_F = 1mA$		--	0.32	V
	$I_F = 10mA$		--	0.40	V
	$I_F = 30mA$		--	0.50	V
	$I_F = 100mA$		--	1.00	V
Reverse current	$V_R = 25V$	I_R	--	2.0	μA
Total Capacitance	$V_R = 1V, f = 1.0MHz$	C_T	--	10	pF
Reverse Recovery Time	$I_F = I_R = 10mA, R_L = 100\Omega, I_{RR} = 1mA$	t_{rr}	--	5.0	nS

Tape & Reel specification

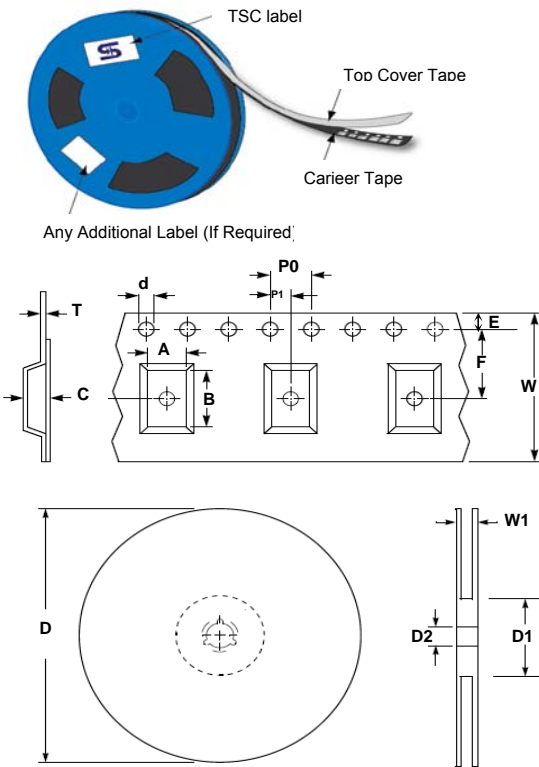

Item	Symbol	Dimension(mm)
Carrier width	A	3.15 ±0.10
Carrier length	B	2.77 ±0.10
Carrier depth	C	1.22 ±0.10
Sprocket hole	d	1.50 ± 0.10
Reel outside diameter	D	178 ± 1
Reel inner diameter	D1	55 Min
Feed hole width	D2	13.0 ± 0.20
Sprocket hole position	E	1.75 ±0.10
Punch hole position	F	3.50 ±0.05
Sprocket hole pitch	P0	4.00 ±0.10
Embossment center	P1	2.00 ±0.05
Overall tape thickness	T	0.229 ±0.013
Tape width	W	8.10 ±0.20
Reel width	W1	12.30 ±0.20

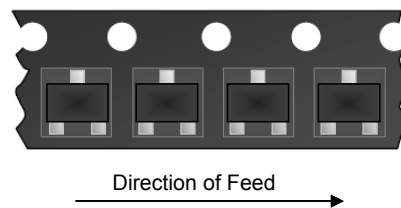

Small Signal Diode

Rating and Characteristic Curves

FIG 1 Typical Forward Characteristics

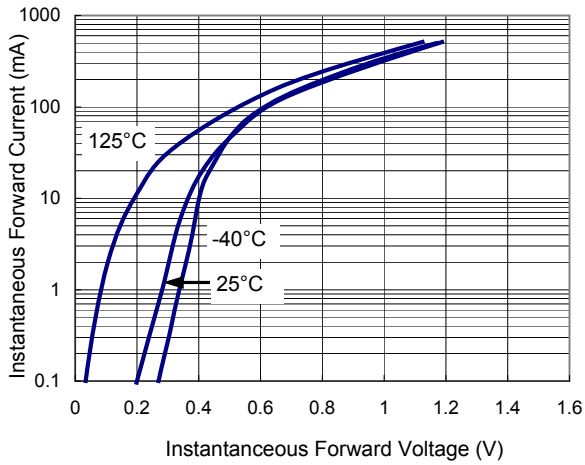

FIG 2 Typical Reverse Characteristics

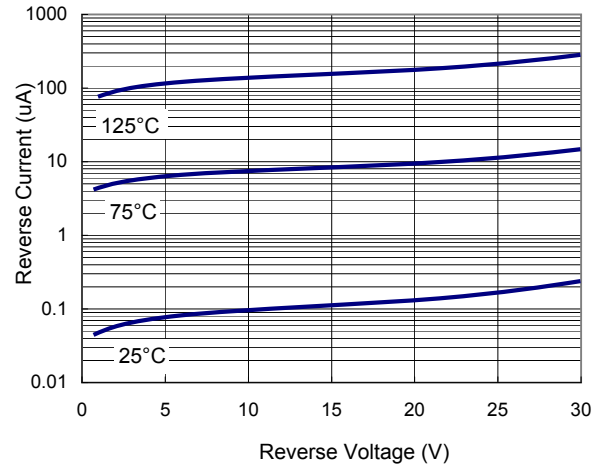

FIG 3 Admissible Power Dissipation Curve

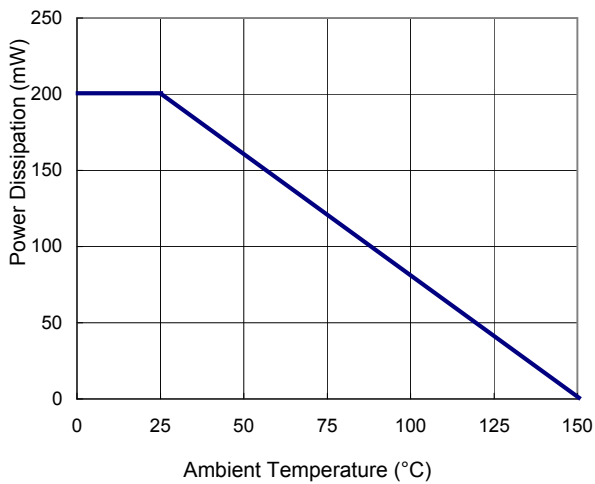

FIG 4 Typical Junction Capacitance

