

**SILICON PLANAR EPITAXIAL TRANSISTORS**

**BC327/A BC328 PNP  
BC337/A BC338 NPN**

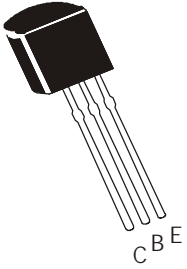

**TO-92  
Plastic Package**

For Lead Free Parts, Device Part # will be Prefixed with "T"

General Purpose Transistors Best Suited for use in Driver and Output Stages of Audio Amplifier

**ABSOLUTE MAXIMUM RATINGS (T<sub>a</sub>=25°C)**

| DESCRIPTION                                      | SYMBOL                            | BC327/337 | BC327A/337A  | BC328/338 | UNITS |
|--|-----------------------------------|-----------|--------------|-----------|-------|
| Collector Emitter Voltage                        | V <sub>CEO</sub>                  | 45        | 60           | 25        | V     |
| Collector Emitter Voltage                        | V <sub>CES</sub>                  | 50        | 60           | 30        | V     |
| Emitter Base Voltage                             | V <sub>EBO</sub>                  |           | 5            |           | V     |
| Collector Current Continuous                     | I <sub>C</sub>                    |           | 800          |           | mA    |
| Collector Current Peak                           | I <sub>CM</sub>                   |           | 1000         |           | mA    |
| Emitter Current Peak                             | I <sub>EM</sub>                   |           | 1000         |           | mA    |
| Base Current Continuous                          | I <sub>B</sub>                    |           | 100          |           | mA    |
| Base Current Peak                                | I <sub>BM</sub>                   |           | 200          |           | mA    |
| Power Dissipation at T <sub>a</sub> =25°C        | P <sub>D</sub>                    |           | 625          |           | mW    |
| Derate Above 25°C                                |                                   |           | 5            |           | mW/°C |
| Operating And Storage Junction Temperature Range | T <sub>j</sub> , T <sub>stg</sub> |           | - 65 to +150 |           | °C    |

**THERMAL RESISTANCE**

|                                 |                       |     |      |
|---------------------------------|-----------------------|-----|------|
| Junction to Ambient in free air | R <sub>th (j-a)</sub> | 200 | °C/W |
|---------------------------------|-----------------------|-----|------|

**ELECTRICAL CHARACTERISTICS (T<sub>a</sub>=25°C unless specified otherwise)**

| DESCRIPTION                          | SYMBOL                 | TEST CONDITION  | MIN | MAX | UNITS |
|--------------------------------------|------------------------|---|-----|-----|-------|
| Collector Emitter Voltage            | V <sub>CEO</sub>       | I <sub>C</sub> =1mA, I <sub>B</sub> =0                          |     |     |       |
|                                      |                        | <b>BC327/337</b>  | 45  |     | V     |
|                                      |                        | <b>BC327A/337A</b>  | 60  |     | V     |
|                                      |                        | <b>BC328/338</b>  | 25  |     | V     |
| Collector Emitter Voltage            | V <sub>CES</sub>       | I <sub>C</sub> =100μA, I <sub>E</sub> =0                        |     |     |       |
|                                      |                        | <b>BC327/337</b>  | 50  |     | V     |
|                                      |                        | <b>BC327A/337A</b>  | 60  |     | V     |
|                                      |                        | <b>BC328/338</b>  | 30  |     | V     |
| Emitter Base Voltage                 | V <sub>EBO</sub>       | I <sub>E</sub> =10μA, I <sub>C</sub> =0                         | 5.0 |     | V     |
| Collector Cut Off Current            | I <sub>CB0</sub>       | V <sub>CB</sub> =20V, I <sub>E</sub> =0                         |     | 100 | nA    |
|                                      |                        | V <sub>CB</sub> =20V, I <sub>E</sub> =0, T <sub>J</sub> =150 °C |     | 5   | μA    |
| Emitter Cut Off Current              | I <sub>EBO</sub>       | V <sub>EB</sub> =5V, I <sub>C</sub> =0                          |     | 10  | μA    |
| Collector Emitter Saturation Voltage | *V <sub>CE (sat)</sub> | I <sub>C</sub> =500mA, I <sub>B</sub> =50mA                     |     | 0.7 | V     |
| Base Emitter On Voltage              | *V <sub>BE (on)</sub>  | I <sub>C</sub> =500mA, V <sub>CE</sub> =1V                      |     | 1.2 | V     |

\*Pulse Test: Pulse Width ≤ 300ms, Duty Cycle ≤ 2%

# SILICON PLANAR EPITAXIAL TRANSISTORS

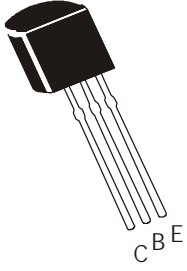

**BC327/A BC328 PNP**  
**BC337/A BC338 NPN**

**TO-92**  
**Plastic Package**

For Lead Free Parts, Device Part #  
 will be Prefixed with "T"

## ELECTRICAL CHARACTERISTICS ( $T_a=25^\circ\text{C}$ unless specified otherwise)

| DESCRIPTION     | SYMBOL     | TEST CONDITION                          | MIN | MAX | UNITS |
|-----------------|------------|---|-----|-----|-------|
| DC Current Gain | * $h_{FE}$ | $I_C=100\text{mA}$ , $V_{CE}=1\text{V}$ |     |     |       |
|                 |            | <b>BC327A/337A</b>                      | 100 | 400 |       |
|                 |            | <b>BC327/328, BC337/338</b>             | 100 | 600 |       |
|                 |            | <b>BC327/328, BC337/338</b>             |     |     |       |
|                 |            | <b>Group-10</b>                         | 63  | 160 |       |
|                 |            | <b>Group-16</b>                         | 100 | 250 |       |
|                 |            | $I_C=500\text{mA}$ , $V_{CE}=1\text{V}$ |     |     |       |
|                 |            | <b>Group-25</b>                         | 160 | 400 |       |
|                 |            | <b>Group-40</b>                         | 250 | 600 |       |
|                 |            |   | 40  |     |       |

## SMALL SIGNAL CHARACTERISTICS

| DESCRIPTION           | SYMBOL   | TEST CONDITION  | TYP        | UNITS |
|-----------------------|----------|---|------------|-------|
| Transistors Frequency | $f_T$    | $I_C=10\text{mA}$ , $V_{CE}=5\text{V}$ , $f=35\text{MHz}$ |            |       |
|                       |          |   | <b>NPN</b> | 200   |
|                       |          | <b>PNP</b>  | 100        | MHz   |
| Output Capacitance    | $C_{ob}$ | $V_{CB}=10\text{V}$ , $I_E=0$ , $f=1\text{MHz}$           |            |       |
|                       |          |   | <b>NPN</b> | 5     |
|                       |          | <b>PNP</b>  | 8          | pF    |

\*Pulse Test: Pulse Width  $\leq 300\mu\text{s}$ , Duty Cycle  $\leq 2\%$

BC327\_338Rev\_3 290606D

TO-92 Leaded Plastic Package

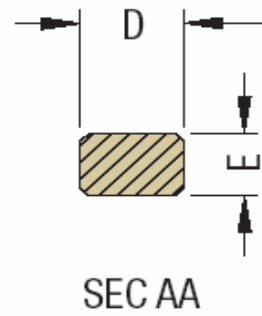
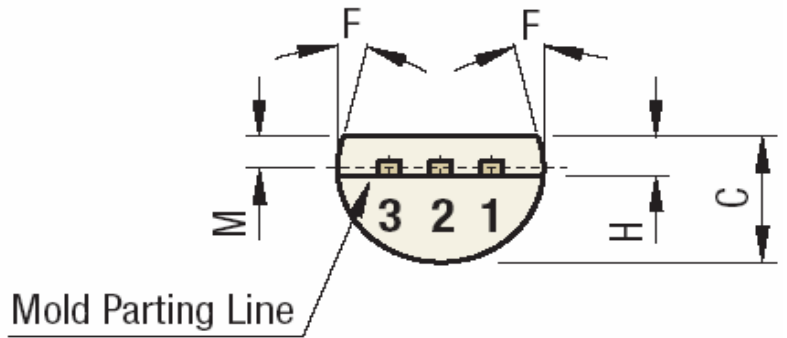
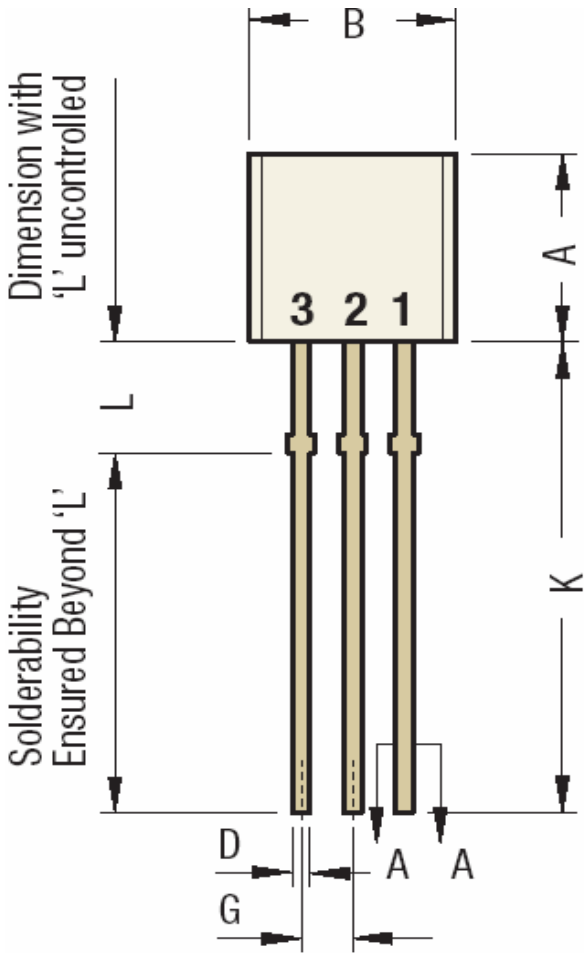

| DIM | Min  | Max  |
|-----|------|------|
| A   | 4.32 | 5.33 |
| B   | 4.45 | 5.20 |
| C   | 3.18 | 4.19 |
| D   | 0.40 | 0.55 |
| E   | 0.30 | 0.55 |
| F   | 5°   |      |

All Dimensions are in mm

| DIM | Min   | Max   |
|-----|-------|-------|
| G   | 1.14  | 1.40  |
| H   | 1.20  | 1.80  |
| K   | 12.5  |       |
| L   | 1.982 | 2.082 |
| M   | 1.03  | 1.53  |

- Pin 1 Emitter
- Pin 2 Base
- Pin 3 Collector

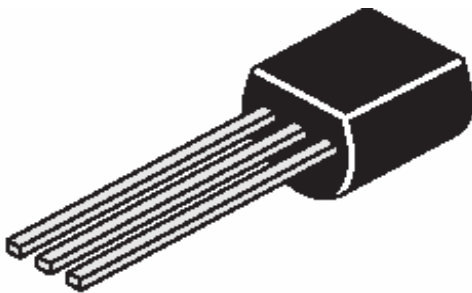

TO-92 Tape and Ammo Packaging

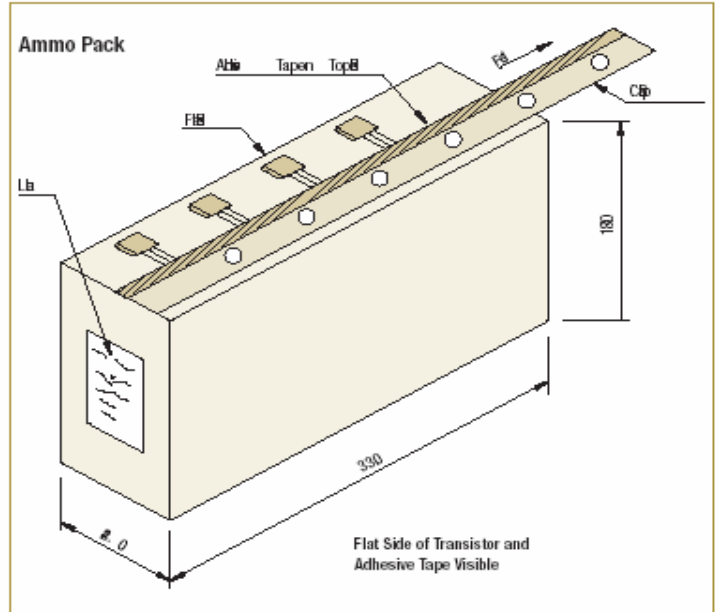
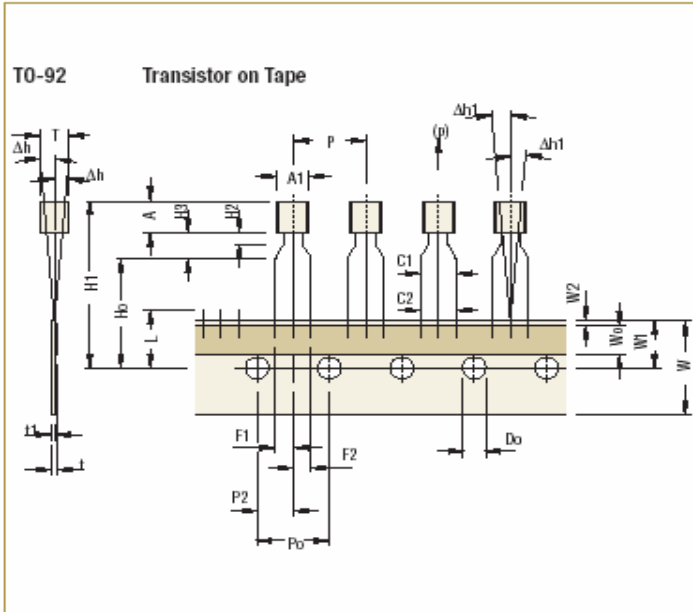

All Dimensions are in mm

Tape Specifications

| Item description                                   | Symbol | TO-92 |      |      |           |
|--|--------|-------|------|------|-----------|
|  |        | Min   | Nom  | Max  | Tol       |
| Body width   | A1     | 4.45  |      | 5.20 |           |
| Body height  | A      | 4.32  |      | 5.33 |           |
| Body thickness                                     | T      | 3.18  |      | 4.19 |           |
| Pitch of component <sup>Cr</sup>                   | P      |       | 12.7 |      | ±1.0      |
| Feed hole pitch <sup>§1</sup>                      | Po     |       | 12.7 |      | ±0.3      |
| Feed hole center to component centre <sup>§2</sup> | P2     |       | 6.35 |      | ±0.4      |
| Comp. alignment, Side view <sup>§3</sup>           | Dh     |       | 0    | 1.0  |           |
| Comp. alignment, Front view <sup>§3</sup>          | Dh1    |       | 0    | 1.3  |           |
| Tape width <sup>Cr</sup>                           | W      |       | 18   |      | ±0.5      |
| Hold down tape width <sup>Cr</sup>                 | W0     |       | 6    |      | ±0.2      |
| Hole position                                      | W1     |       | 9    |      | +0.7 -0.5 |
| Hold-down tape position                            | W2     | 0.0   |      | 0.7  |           |
| Lead wire clinch height                            | Ho     |       | 16   |      | ±0.5      |
| Component height                                   | H1     |       |      | 24.0 |           |
| Length of snipped leads                            | L      |       |      | 11.0 |           |
| Feed hole diameter <sup>Cr</sup>                   | Do     |       | 4    |      | ±0.2      |
| Total tape thickness <sup>§4</sup>                 | t      |       |      | 1.2  |           |
| Lead-to-lead distance <sup>Cr</sup>                | F1, F2 | 2.4   |      | 2.7  |           |
| Stand off  | H2     | 0.45  |      | 1.45 |           |
| Clinch height                                      | H3     |       |      | 3.0  |           |
| Lead parallelism <sup>Cr</sup>                     | C1-C2  |       |      | 0.22 |           |
| Pull-out force                                     | (p)    | 6N    |      |      |           |

Taping Specification

- Maximum alignment deviation between leads not to be greater than 0.20 mm.
- Maximum non-cumulative variation between tape feed holes shall not exceed 1 mm in 20 pitches.
- Hold down tape not to exceed beyond the edge(s) carrier tape and there shall be no exposure of adhesive.
- No more than 3 consecutive missing components is permitted.
- A tape trailer, having at least three feed holes is required after the last component.
- Splices shall not interfere with the sprocket feed holes.

§1 Cumulative pitch error 1.0 mm/20 pitch.

§2 To be measured at bottom of clinch.

§3 At top of body.

§4 t1 = 0.3 – 0.6 mm

Cr Critical Dimension.

All Dimensions are in mm

**Packaging Information**

T & A: Tape and Ammo Pack; T & R: Tape and Red; Bulk: Loose in Poly bags; Tube: Tube and Ammo Pack; k: 1.000

| Package/Case Type | Packaging Type | Std. Packing |     | Inner Carton        |                   | Outer Carton |                     |                   |
|-------------------|----------------|--------------|-----|---------------------|-------------------|--------------|---------------------|-------------------|
|                   |                | Qty          | Qty | Size L x W x H (cm) | Gross Weight (Kg) | Qty          | Size L x W x H (cm) | Gross Weight (Kg) |
| TO-92             | Bulk           | 1,000        | 5K  | 19x19x8             | 1.10              | 80K          | 43x40x35            | 20.0              |
|                   | T&A            | 2,000        | 2K  | 32x4.5x20           | 0.70              | 40K          | 43x40x35            | 15.20             |

**Component Disposal Instructions**

1. CDIL Semiconductor Devices are RoHS compliant, customers are requested to please dispose as per prevailing Environmental Legislation of their Country.
2. In Europe, please dispose as per EU Directive 2002/96/EC on Waste Electrical and Electronic Equipment (WEEE).

**Customer Notes**

**Disclaimer**

The product information and the selection guides facilitate selection of the CDIL's Semiconductor Device(s) best suited for application in your product(s) as per your requirement. It is recommended that you completely review our Data Sheet(s) so as to confirm that the Device(s) meet functionality parameters for your application. The information furnished in the Data Sheet and on the CDIL Web Site/CD are believed to be accurate and reliable. CDIL however, does not assume responsibility for inaccuracies or incomplete information. Furthermore, CDIL does not assume liability whatsoever, arising out of the application or use of any CDIL product; neither does it convey any license under its patent rights nor rights of others. These products are not designed for use in life saving/support appliances or systems. CDIL customers selling these products (either as individual Semiconductor Devices or incorporated in their end products), in any life saving/support appliances or systems or applications do so at their own risk and CDIL will not be responsible for any damages resulting from such sale(s). CDIL strives for continuous improvement and reserves the right to change the specifications of its products without prior notice.



CDIL is a registered Trademark of  
**Continental Device India Limited**

C-120 Naraina Industrial Area, New Delhi 110 028, India.

Telephone + 91-11-2579 6150, 4141 1112 Fax + 91-11-2579 5290, 4141 1119

email@cdil.com

www.cdilsemi.com

BC327\_338Rev\_3 290606D