



BC327/328

PNP EPITAXIAL SILICON TRANSISTOR

SWITCHING AND AMPLIFIER APPLICATIONS

■ **FEATURES**

- * Suitable for AF-Driver stages and low power output stages
- * Complement to UTC **BC337/338**

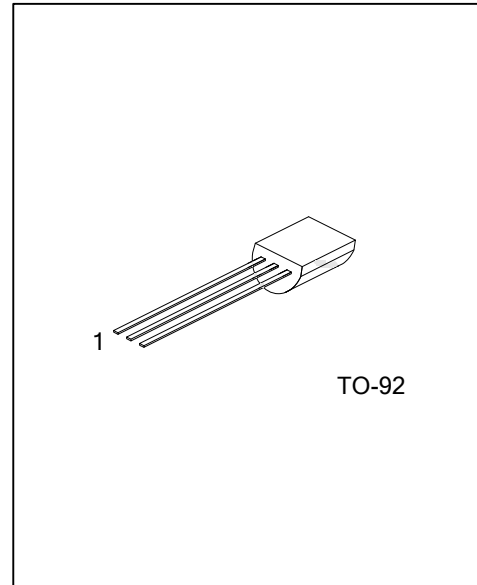

■ **ORDERING INFORMATION**

Ordering Number		Package	Pin Assignment			Packing
Lead Free	Halogen Free		1	2	3	
BC327L-xx-T92-B	BC327G-xx-T92-B	TO-92	C	B	E	Tape Box
BC327L-xx-T92-K	BC327G-xx-T92-K	TO-92	C	B	E	Bulk
BC328L-xx-T92-B	BC328G-xx-T92-B	TO-92	C	B	E	Tape Box
BC328L-xx-T92-K	BC328G-xx-T92-K	TO-92	C	B	E	Bulk

Note: Pin Assignment: C: Collector B: Base E: Emitter

<p>BC327L-xx-T92-B</p>	<p>(1) B: Tape Box, K: Bulk (2) T92: TO-92 (3) xx: refer to CLASSIFICATION OF h_{FE} (4) L: Lead Free, G: Halogen Free and Lead Free</p>
------------------------	--

■ **MARKING**

BC327	BC328

BC327/328

PNP EPITAXIAL SILICON TRANSISTOR

■ ABSOLUTE MAXIMUM RATING ($T_A=25^{\circ}\text{C}$, unless otherwise specified)

PARAMETER	SYMBOL	RATINGS	UNIT
Collector-emitter voltage	BC327	-50	V
	BC328	-30	V
Collector-emitter voltage	BC327	-45	V
	BC328	-25	V
Emitter-base voltage	V_{EBO}	-5	V
Collector current (DC)	I_C	-800	mA
Collector dissipation	P_C	625	mW
Junction Temperature	T_J	125	$^{\circ}\text{C}$
Operating Temperature	T_{OPR}	-20 ~ +85	$^{\circ}\text{C}$
Storage Temperature	T_{STG}	-40 ~ +150	$^{\circ}\text{C}$

Note: Absolute maximum ratings are those values beyond which the device could be permanently damaged. Absolute maximum ratings are stress ratings only and functional device operation is not implied.

■ ELECTRICAL CHARACTERISTICS ($T_A=25^{\circ}\text{C}$, unless otherwise specified)

PARAMETER	SYMBOL	TEST CONDITIONS	MIN	TYP	MAX	UNIT
Collector-emitter breakdown voltage	BC327	$I_C=-10\text{mA}, I_B=0$	-45			V
	BC328		-25			V
Collector-emitter breakdown voltage	BC327	$I_C=-0.1\text{mA}, V_{BE}=0$	-50			V
	BC328		-30			V
Emitter-base breakdown voltage	BV_{EBO}	$I_E=-10\text{mA}, I_C=0$	-5			V
Collector Cut-off Current	BC327	$V_{CE}=-45\text{V}, I_B=0$		-2	-100	V
	BC328	$V_{CE}=-25\text{V}, I_B=0$		-2	-100	V
DC current gain	h_{FE1}	$V_{CE}=-1\text{V}, I_C=-100\text{mA}$	100		630	
	h_{FE2}	$V_{CE}=-1\text{V}, I_C=-300\text{mA}$	40			
Collector-emitter saturation voltage	$V_{CE(SAT)}$	$I_C=-500\text{mA}, I_B=-50\text{mA}$			-0.7	V
Base-emitter on voltage	$V_{BE(ON)}$	$V_{CE}=-1\text{V}, I_C=-300\text{mA}$			-1.2	V
Current gain bandwidth product	f_T	$V_{CE}=-5\text{V}, I_C=-10\text{mA}, f=20\text{MHz}$		100		MHz
Output Capacitance	C_{ob}	$V_{CB}=-10\text{V}, I_E=0, f=1\text{MHz}$		12		pF

■ CLASSIFICATION OF h_{FE}

RANK	16	25	40
h_{FE1}	100-250	160-400	250-630
h_{FE2}	60~	100~	170~

■ TYPICAL CHARACTERISTICS

Figure 1. Static Characteristic

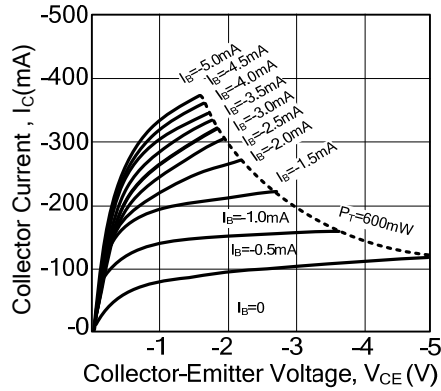

Figure 2. Static Characteristic

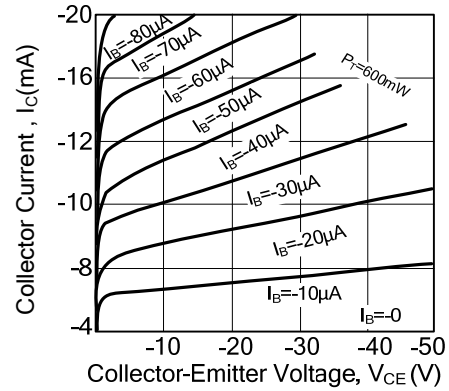

Figure 3. DC Current Gain

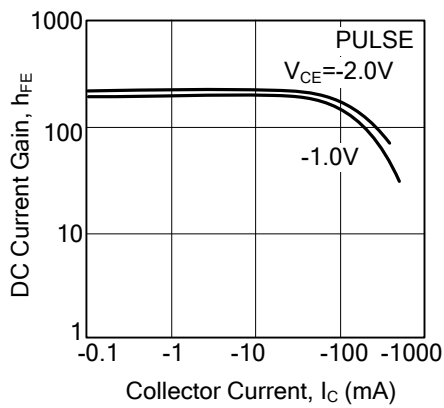

Figure 4. Base-Emitter Saturation Voltage

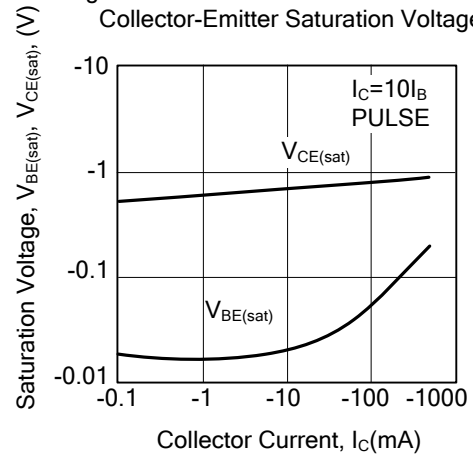

Figure 5. Base-Emitter On Voltage

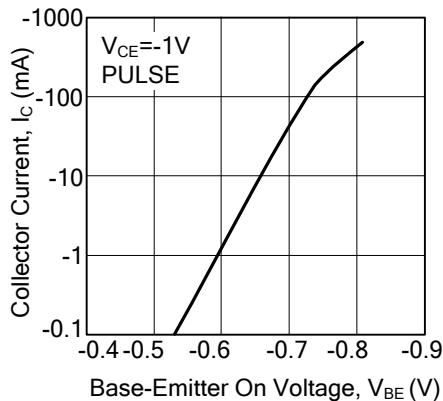
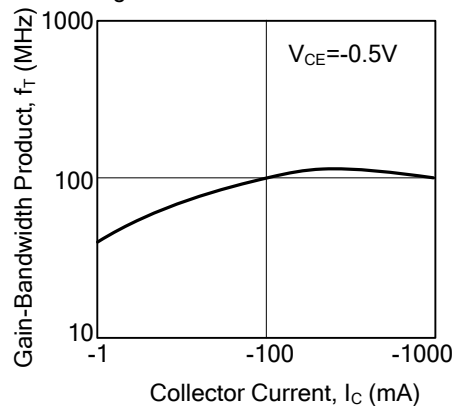
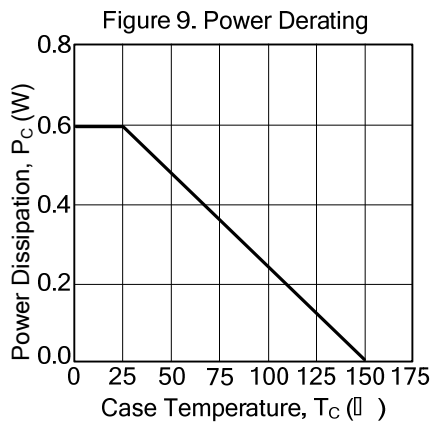
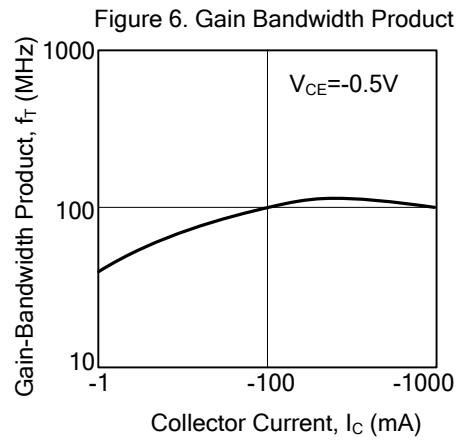
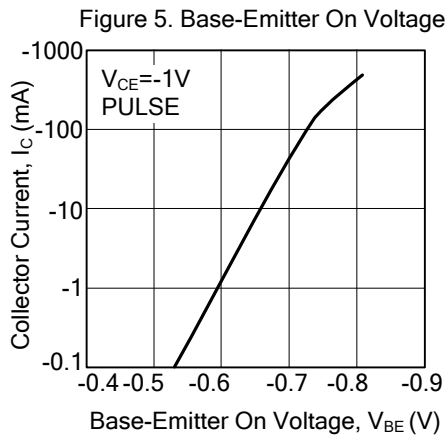

Figure 6. Gain Bandwidth Product



■ TYPICAL CHARACTERISTICS(Cont.)



UTC assumes no responsibility for equipment failures that result from using products at values that exceed, even momentarily, rated values (such as maximum ratings, operating condition ranges, or other parameters) listed in products specifications of any and all UTC products described or contained herein. UTC products are not designed for use in life support appliances, devices or systems where malfunction of these products can be reasonably expected to result in personal injury. Reproduction in whole or in part is prohibited without the prior written consent of the copyright owner. The information presented in this document does not form part of any quotation or contract, is believed to be accurate and reliable and may be changed without notice.