

# BC637; BCP55; BCX55

60 V, 1 A NPN medium power transistors

Rev. 07 — 25 June 2007

Product data sheet

## 1. Product profile

### 1.1 General description

NPN medium power transistor series.

Table 1. Product overview

| Type number <sup>[1]</sup> | Package |        |        | PNP complement |
|----------------------------|---------|--------|--------|----------------|
|                            | NXP     | JEITA  | JEDEC  |                |
| BC637 <sup>[2]</sup>       | SOT54   | SC-43A | TO-92  | BC638          |
| BCP55                      | SOT223  | SC-73  | -      | BCP52          |
| BCX55                      | SOT89   | SC-62  | TO-243 | BCX52          |

[1] Valid for all available selection groups.

[2] Also available in SOT54A and SOT54 variant packages (see [Section 2](#)).

### 1.2 Features

- High current
- Two current gain selections
- High power dissipation capability

### 1.3 Applications

- Linear voltage regulators
- Low-side switches
- MOSFET drivers
- Amplifiers

### 1.4 Quick reference data

Table 2. Quick reference data

| Symbol    | Parameter                 | Conditions                     | Min | Typ | Max | Unit |
|-----------|---------------------------|--------------------------------|-----|-----|-----|------|
| $V_{CEO}$ | collector-emitter voltage | open base                      | -   | -   | 60  | V    |
| $I_C$     | collector current         |                                | -   | -   | 1   | A    |
| $I_{CM}$  | peak collector current    | single pulse; $t_p \leq 1$ ms  | -   | -   | 1.5 | A    |
| $h_{FE}$  | DC current gain           | $V_{CE} = 2$ V; $I_C = 150$ mA | 63  | -   | 250 |      |
|           | $h_{FE}$ selection -10    | $V_{CE} = 2$ V; $I_C = 150$ mA | 63  | -   | 160 |      |
|           | $h_{FE}$ selection -16    | $V_{CE} = 2$ V; $I_C = 150$ mA | 100 | -   | 250 |      |

## 2. Pinning information

**Table 3. Pinning**

| Pin                  | Description | Simplified outline | Symbol        |
|----------------------|-------------|--------------------|---------------|
| <b>SOT54</b>         |             |                    |               |
| 1                    | base        | <p>001aab347</p>   | <p>sym056</p> |
| 2                    | collector   |                    |               |
| 3                    | emitter     |                    |               |
| <b>SOT54A</b>        |             |                    |               |
| 1                    | base        | <p>001aab348</p>   | <p>sym056</p> |
| 2                    | collector   |                    |               |
| 3                    | emitter     |                    |               |
| <b>SOT54 variant</b> |             |                    |               |
| 1                    | base        | <p>001aab447</p>   | <p>sym056</p> |
| 2                    | collector   |                    |               |
| 3                    | emitter     |                    |               |
| <b>SOT223</b>        |             |                    |               |
| 1                    | base        |                    | <p>sym016</p> |
| 2                    | collector   |                    |               |
| 3                    | emitter     |                    |               |
| 4                    | collector   |                    |               |
| <b>SOT89</b>         |             |                    |               |
| 1                    | emitter     |                    | <p>sym042</p> |
| 2                    | collector   |                    |               |
| 3                    | base        |                    |               |

### 3. Ordering information

**Table 4. Ordering information**

| Type number <sup>[1]</sup> | Package |  |         |
|----------------------------|---------|--|---------|
|                            | Name    | Description  | Version |
| BC637 <sup>[2]</sup>       | SC-43A  | plastic single-ended leaded (through hole) package; 3 leads                    | SOT54   |
| BCP55                      | SC-73   | plastic surface-mounted package with increased heatsink; 4 leads               | SOT223  |
| BCX55                      | SC-62   | plastic surface-mounted package; collector pad for good heat transfer; 3 leads | SOT89   |

[1] Valid for all available selection groups.

[2] Also available in SOT54A and SOT54 variant packages (see [Section 2](#) and [Section 9](#)).

### 4. Marking

**Table 5. Marking codes**

| Type number | Marking code |
|-------------|--------------|
| BC637       | C637         |
| BC637-16    | C63716       |
| BCP55       | BCP55        |
| BCP55-10    | BCP55/10     |
| BCP55-16    | BCP55/16     |
| BCX55       | BE           |
| BCX55-10    | BG           |
| BCX55-16    | BM           |

## 5. Limiting values

**Table 6. Limiting values**

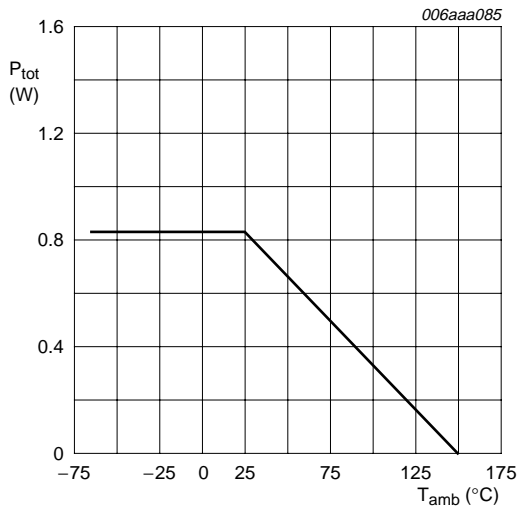
*In accordance with the Absolute Maximum Rating System (IEC 60134).*

| Symbol    | Parameter                 | Conditions                       | Min   | Max   | Unit |   |
|-----------|---------------------------|----------------------------------|-------|-------|------|---|
| $V_{CBO}$ | collector-base voltage    | open emitter                     | -     | 60    | V    |   |
| $V_{CEO}$ | collector-emitter voltage | open base                        | -     | 60    | V    |   |
| $V_{EBO}$ | emitter-base voltage      | open collector                   | -     | 5     | V    |   |
| $I_C$     | collector current         |                                  | -     | 1     | A    |   |
| $I_{CM}$  | peak collector current    | single pulse;<br>$t_p \leq 1$ ms | -     | 1.5   | A    |   |
| $I_{BM}$  | peak base current         | single pulse;<br>$t_p \leq 1$ ms | -     | 0.2   | A    |   |
| $P_{tot}$ | total power dissipation   | $T_{amb} \leq 25$ °C             |       |       |      |   |
|           |                           |                                  | BC637 | [1] - | 0.83 | W |
|           |                           |                                  | BCP55 | [1] - | 0.64 | W |
|           |                           |                                  |       | [2] - | 0.96 | W |
|           |                           |                                  | BCX55 | [1] - | 0.5  | W |
|           |                           |                                  |       | [2] - | 0.85 | W |
| [3] -     | 1.25                      | W                                |       |       |      |   |
| $T_j$     | junction temperature      |                                  | -     | 150   | °C   |   |
| $T_{amb}$ | ambient temperature       |                                  | -65   | +150  | °C   |   |
| $T_{stg}$ | storage temperature       |                                  | -65   | +150  | °C   |   |

[1] Device mounted on an FR4 Printed-Circuit Board (PCB), single-sided copper, tin-plated and standard footprint.

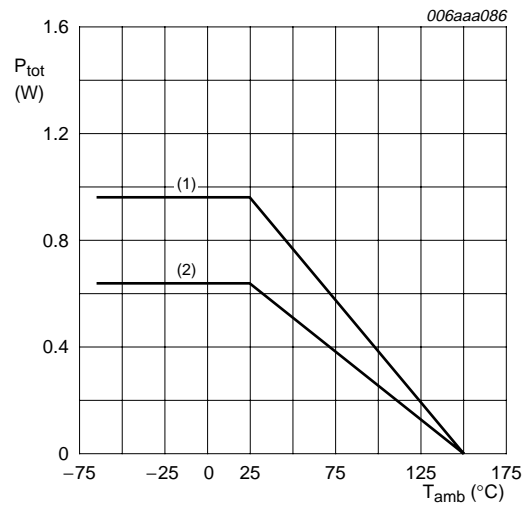
[2] Device mounted on an FR4 PCB, single-sided copper, tin-plated, mounting pad for collector 1 cm<sup>2</sup>.

[3] Device mounted on an FR4 PCB, single-sided copper, tin-plated, mounting pad for collector 6 cm<sup>2</sup>.



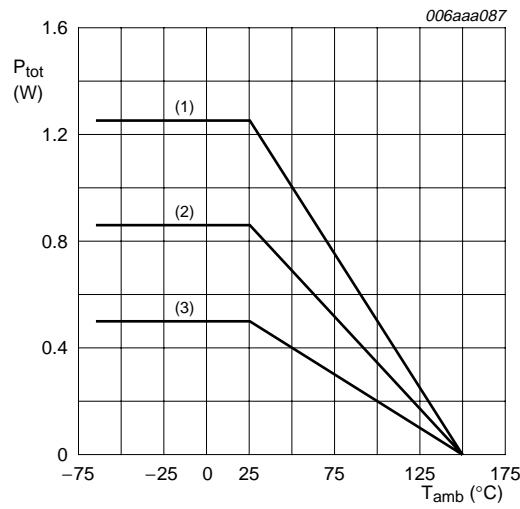
FR4 PCB, standard footprint

**Fig 1. Power derating curve SOT54**



- (1) FR4 PCB, mounting pad for collector 1 cm<sup>2</sup>
- (2) FR4 PCB, standard footprint

**Fig 2. Power derating curves SOT223**



- (1) FR4 PCB, mounting pad for collector 6 cm<sup>2</sup>
- (2) FR4 PCB, mounting pad for collector 1 cm<sup>2</sup>
- (3) FR4 PCB, standard footprint

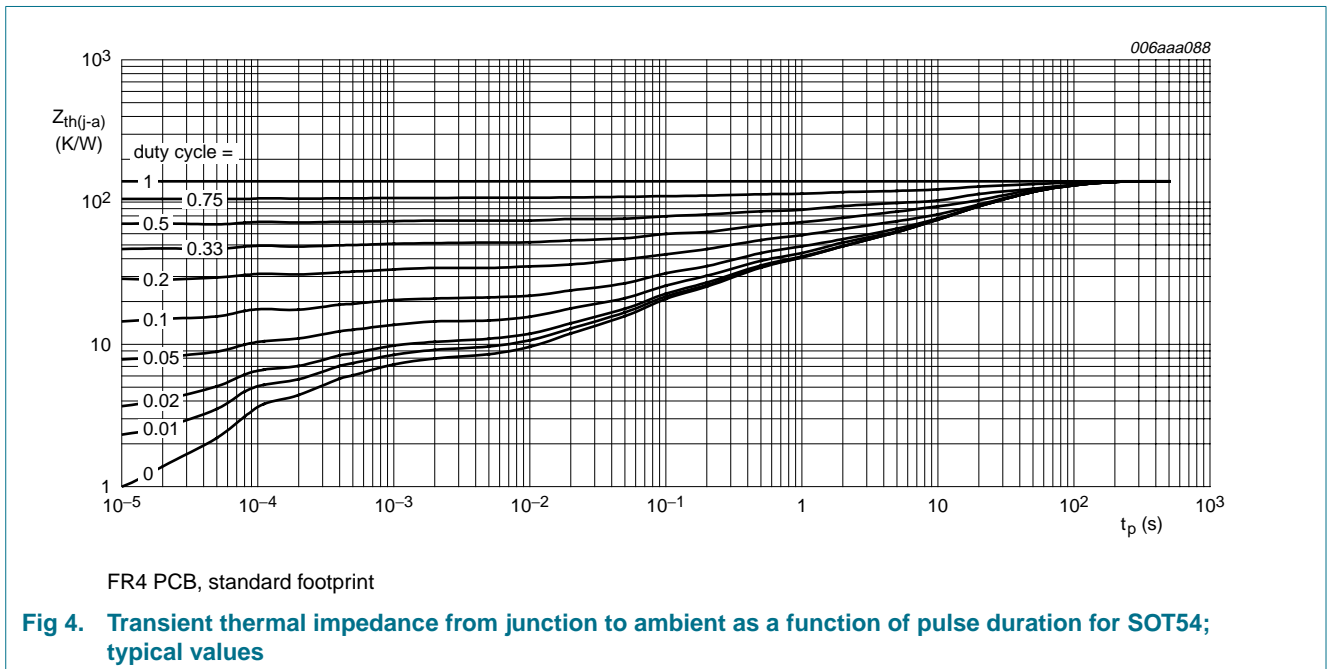
**Fig 3. Power derating curves SOT89**

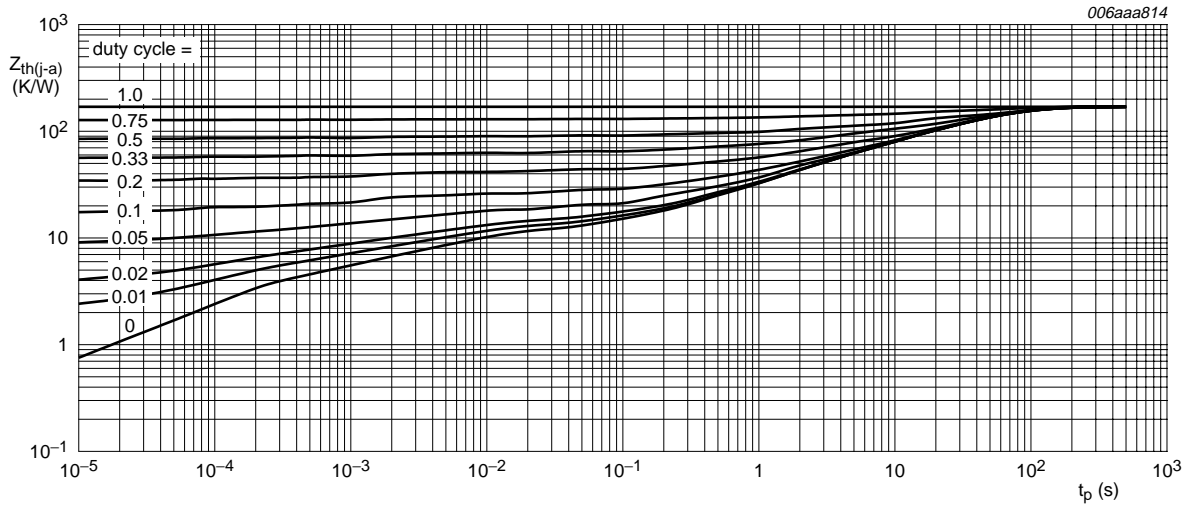
6. Thermal characteristics

Table 7. Thermal characteristics

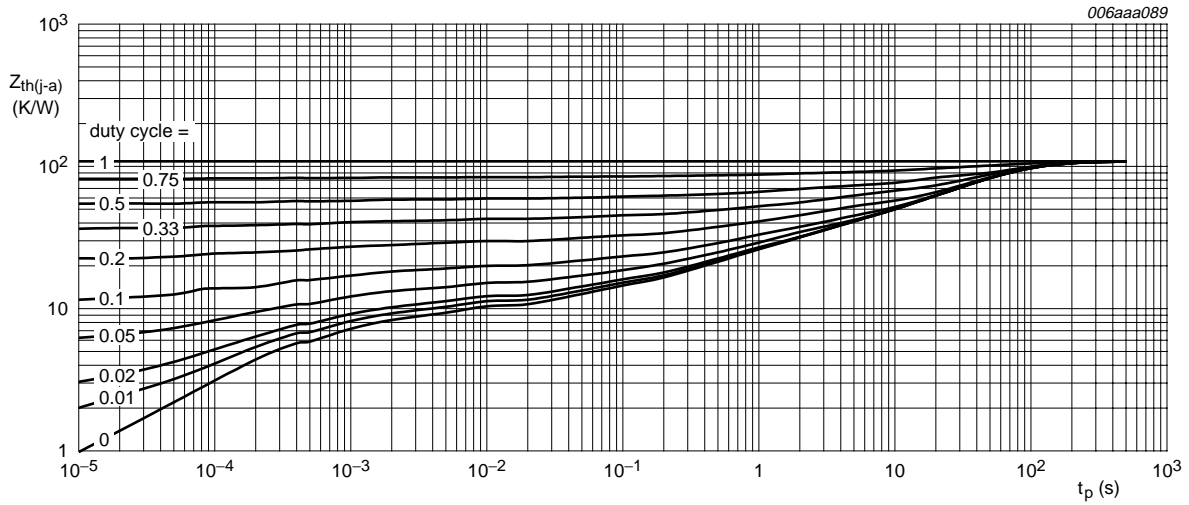
| Symbol         | Parameter  | Conditions  | Min   | Typ | Max | Unit |     |     |
|----------------|--|-------------|-------|-----|-----|------|-----|-----|
| $R_{th(j-a)}$  | thermal resistance from junction to ambient      | in free air |       |     |     |      |     |     |
|                |  |             | BC637 | [1] | -   | -    | 150 | K/W |
|                |  |             | BCP55 | [1] | -   | -    | 195 | K/W |
|                |  |             |       | [2] | -   | -    | 130 | K/W |
|                |  |             | BCX55 | [1] | -   | -    | 250 | K/W |
|                |  |             |       | [2] | -   | -    | 145 | K/W |
| [3]            | -  | -           |       | 100 | K/W |      |     |     |
| $R_{th(j-sp)}$ | thermal resistance from junction to solder point |             |       |     |     |      |     |     |
|                |  | BC637       | -     | -   | 40  | K/W  |     |     |
|                |  | BCP55       | -     | -   | 17  | K/W  |     |     |
|                |  | BCX55       | -     | -   | 30  | K/W  |     |     |

- [1] Device mounted on an FR4 PCB, single-sided copper, tin-plated and standard footprint.
- [2] Device mounted on an FR4 PCB, single-sided copper, tin-plated, mounting pad for collector 1 cm<sup>2</sup>.
- [3] Device mounted on an FR4 PCB, single-sided copper, tin-plated, mounting pad for collector 6 cm<sup>2</sup>.

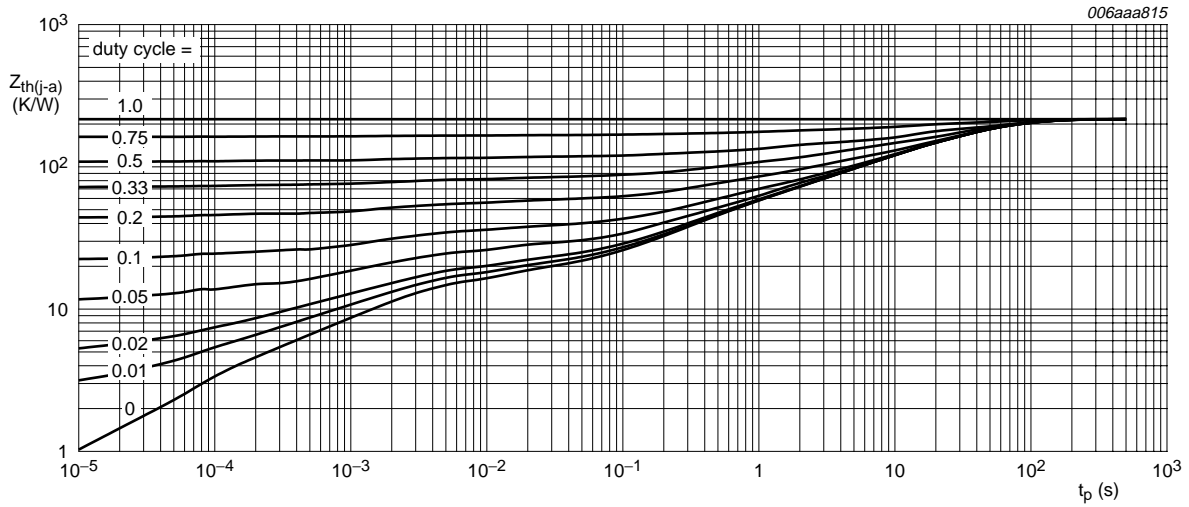




**Fig 5. Transient thermal impedance from junction to ambient as a function of pulse duration for SOT223; typical values**

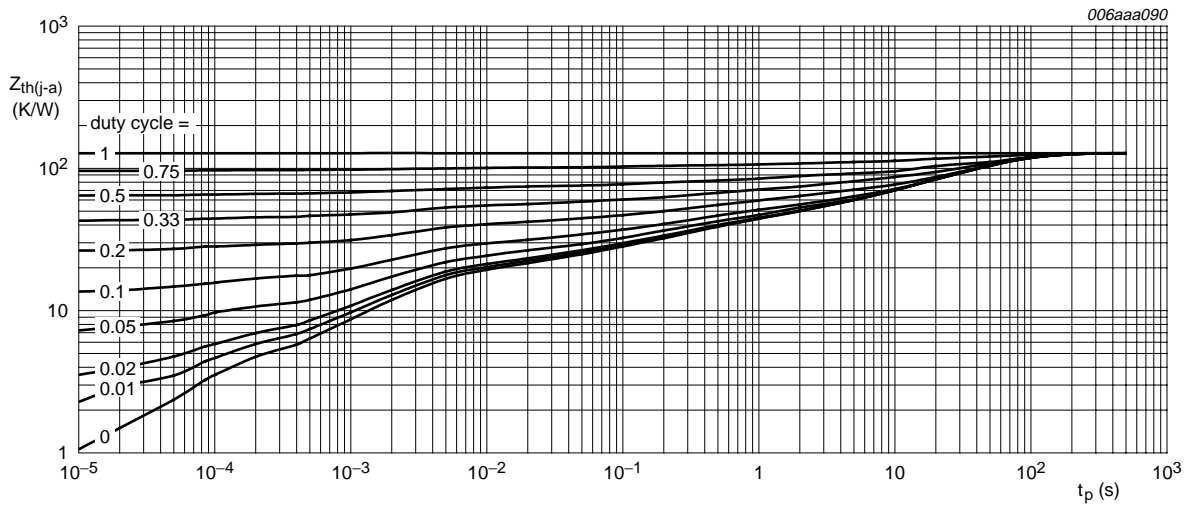


**Fig 6. Transient thermal impedance from junction to ambient as a function of pulse duration for SOT223; typical values**



FR4 PCB, standard footprint

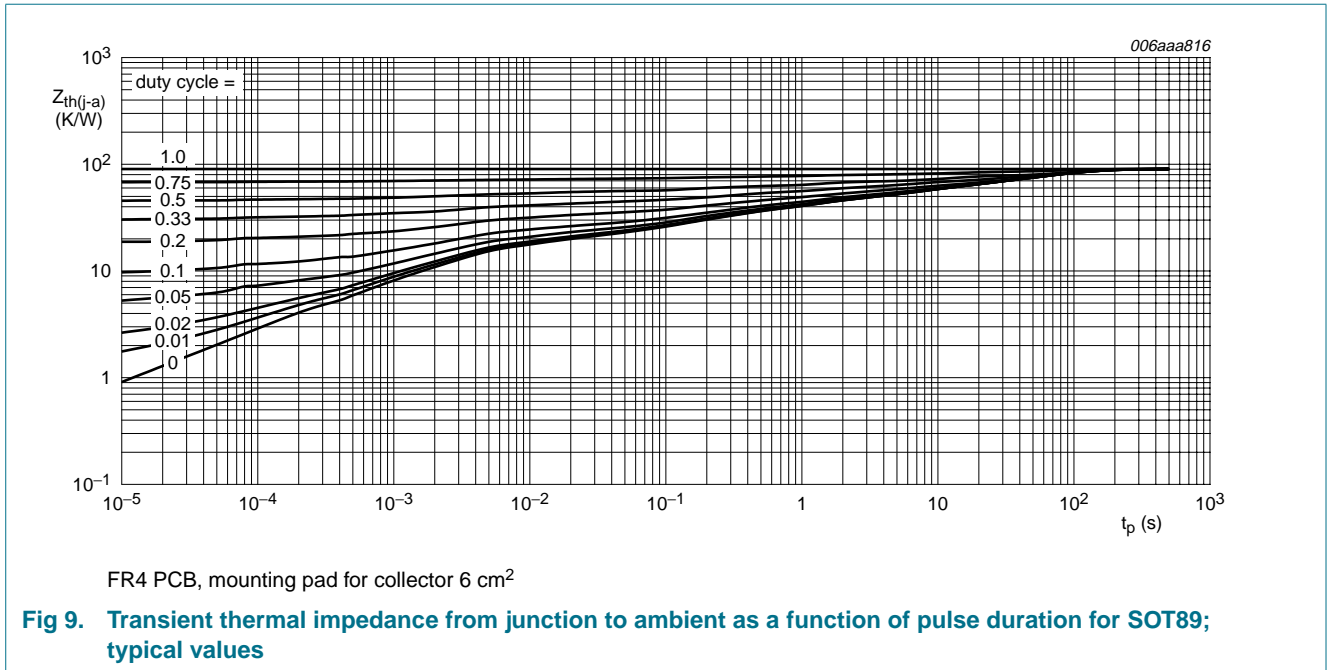
Fig 7. Transient thermal impedance from junction to ambient as a function of pulse duration for SOT89; typical values



FR4 PCB, mounting pad for collector 1 cm<sup>2</sup>

Fig 8. Transient thermal impedance from junction to ambient as a function of pulse duration for SOT89; typical values





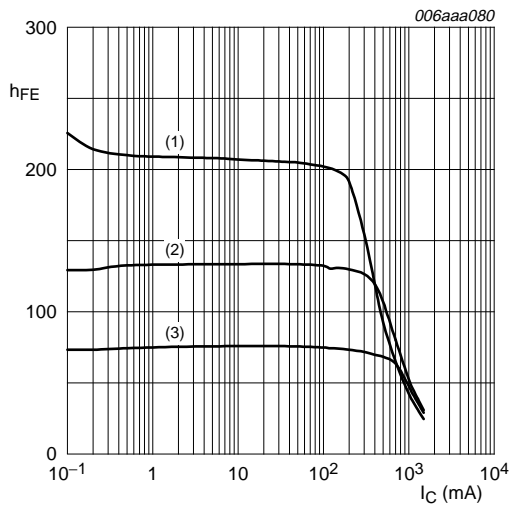
## 7. Characteristics

**Table 8. Characteristics**

*T<sub>amb</sub> = 25 °C unless otherwise specified.*

| Symbol             | Parameter                            | Conditions  | Min    | Typ | Max | Unit |
|--------------------|--------------------------------------|---|--------|-----|-----|------|
| I <sub>CBO</sub>   | collector-base cut-off current       | V <sub>CB</sub> = 30 V; I <sub>E</sub> = 0 A                                | -      | -   | 100 | nA   |
|                    |                                      | V <sub>CB</sub> = 30 V; I <sub>E</sub> = 0 A;<br>T <sub>j</sub> = 150 °C    | -      | -   | 10  | μA   |
| I <sub>EBO</sub>   | emitter-base cut-off current         | V <sub>EB</sub> = 5 V; I <sub>C</sub> = 0 A                                 | -      | -   | 100 | nA   |
| h <sub>FE</sub>    | DC current gain                      | V <sub>CE</sub> = 2 V   |        |     |     |      |
|                    |                                      | I <sub>C</sub> = 5 mA   | 63     | -   | -   |      |
|                    |                                      | I <sub>C</sub> = 150 mA   | 63     | -   | 250 |      |
|                    |                                      | I <sub>C</sub> = 500 mA   | [1] 40 | -   | -   |      |
|                    | DC current gain                      | V <sub>CE</sub> = 2 V   |        |     |     |      |
|                    | h <sub>FE</sub> selection -10        | I <sub>C</sub> = 150 mA   | 63     | -   | 160 |      |
|                    | h <sub>FE</sub> selection -16        | I <sub>C</sub> = 150 mA   | 100    | -   | 250 |      |
| V <sub>CEsat</sub> | collector-emitter saturation voltage | I <sub>C</sub> = 500 mA; I <sub>B</sub> = 50 mA                             | [1] -  | -   | 500 | mV   |
| V <sub>BE</sub>    | base-emitter voltage                 | V <sub>CE</sub> = 2 V; I <sub>C</sub> = 500 mA                              | [1] -  | -   | 1   | V    |
| C <sub>C</sub>     | collector capacitance                | V <sub>CB</sub> = 10 V; I <sub>E</sub> = i <sub>e</sub> = 0 A;<br>f = 1 MHz | -      | 6   | -   | pF   |
| f <sub>T</sub>     | transition frequency                 | V <sub>CE</sub> = 5 V; I <sub>C</sub> = 50 mA;<br>f = 100 MHz               | 100    | 180 | -   | MHz  |

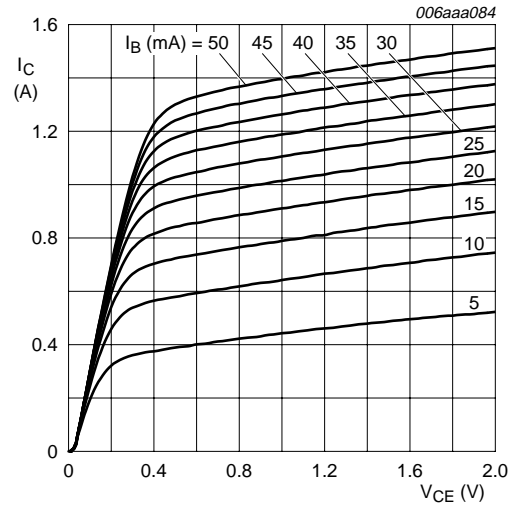
[1] Pulse test: t<sub>p</sub> ≤ 300 μs; δ = 0.02.



$V_{CE} = 2 \text{ V}$

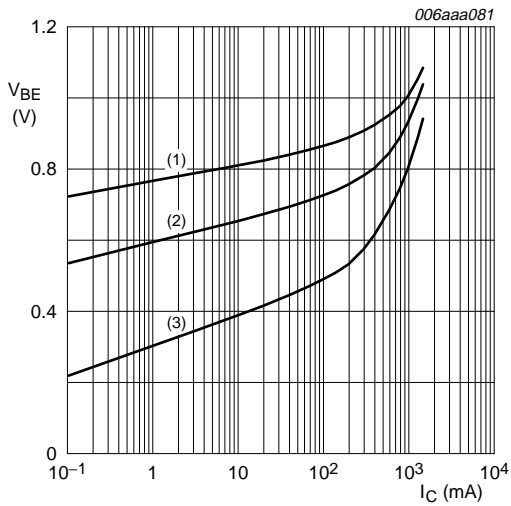
- (1)  $T_{amb} = 150 \text{ }^\circ\text{C}$
- (2)  $T_{amb} = 25 \text{ }^\circ\text{C}$
- (3)  $T_{amb} = -55 \text{ }^\circ\text{C}$

**Fig 10. DC current gain as a function of collector current; typical values**



$T_{amb} = 25 \text{ }^\circ\text{C}$

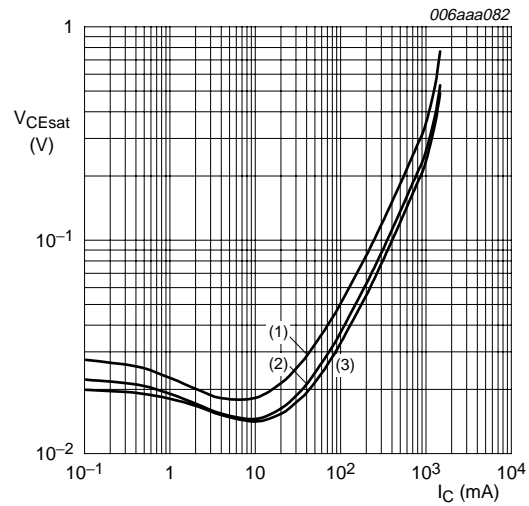
**Fig 11. Collector current as a function of collector-emitter voltage; typical values**



$V_{CE} = 2 \text{ V}$

- (1)  $T_{amb} = -55 \text{ }^\circ\text{C}$
- (2)  $T_{amb} = 25 \text{ }^\circ\text{C}$
- (3)  $T_{amb} = 150 \text{ }^\circ\text{C}$

**Fig 12. Base-emitter voltage as a function of collector current; typical values**

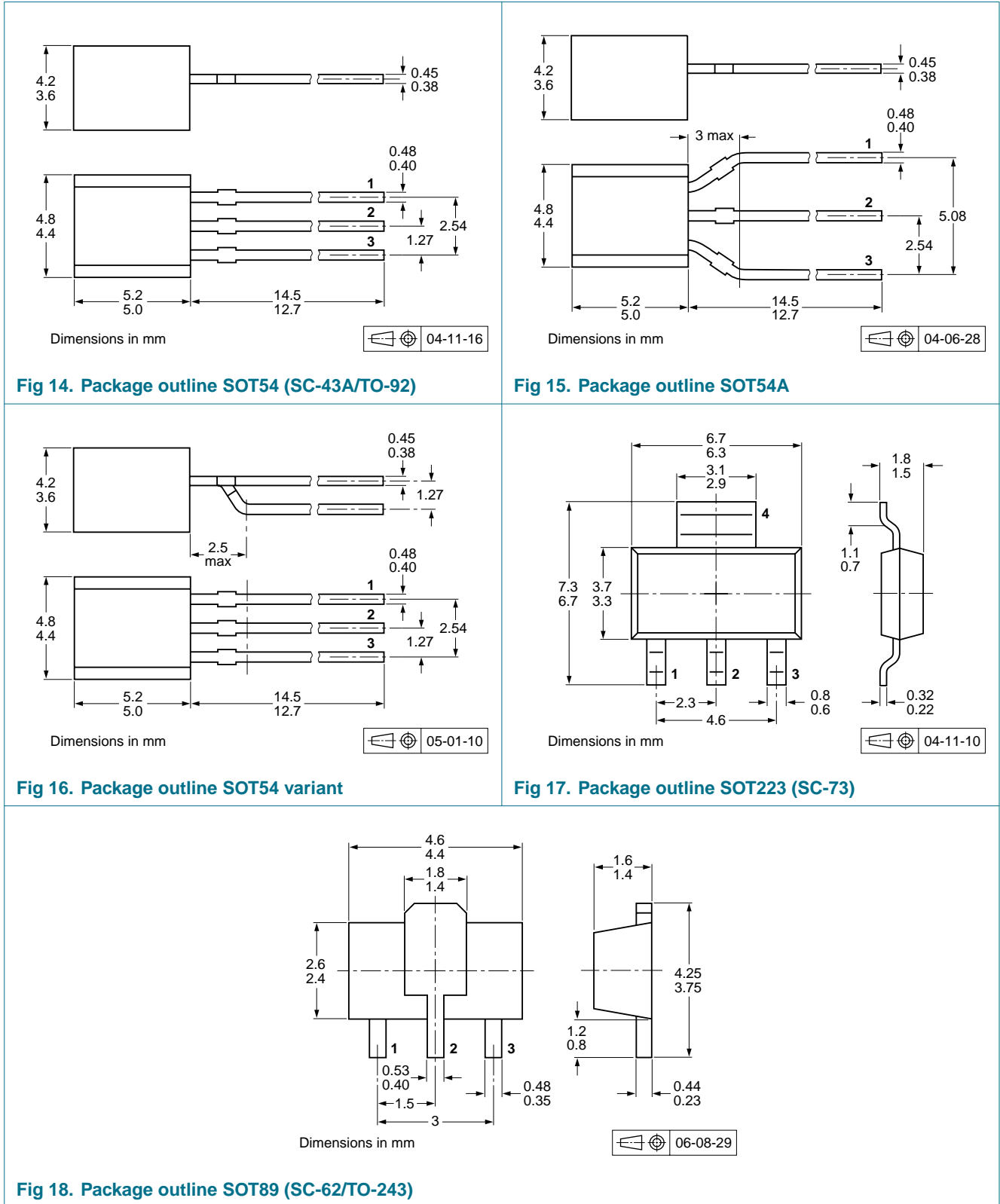


$I_C/I_B = 10$

- (1)  $T_{amb} = 150 \text{ }^\circ\text{C}$
- (2)  $T_{amb} = 25 \text{ }^\circ\text{C}$
- (3)  $T_{amb} = -55 \text{ }^\circ\text{C}$

**Fig 13. Collector-emitter saturation voltage as a function of collector current; typical values**

**8. Package outline**



## 9. Packing information

**Table 9. Packing methods**

The indicated -xxx are the last three digits of the 12NC ordering code.<sup>[1]</sup>

| Type number <sup>[2]</sup> | Package       | Description                         | Packing quantity    |      |      |       |
|----------------------------|---------------|-------------------------------------|---------------------|------|------|-------|
|                            |               |                                     | 1000                | 4000 | 5000 | 10000 |
| BC637                      | SOT54         | bulk, straight leads                | -                   | -    | -412 | -     |
|                            | SOT54A        | tape and reel, wide pitch           | -                   | -    | -    | -116  |
|                            |               | tape ammopack, wide pitch           | -                   | -    | -    | -126  |
|                            | SOT54 variant | bulk, delta pinning                 | -                   | -    | -112 | -     |
| BCP55                      | SOT223        | 8 mm pitch, 12 mm tape and reel     | -115                | -135 | -    | -     |
| BCX55                      | SOT89         | 8 mm pitch, 12 mm tape and reel; T1 | <sup>[3]</sup> -115 | -135 | -    | -     |
|                            |               | 8 mm pitch, 12 mm tape and reel; T3 | <sup>[4]</sup> -120 | -    | -    | -     |

[1] For further information and the availability of packing methods, see [Section 12](#).

[2] Valid for all available selection groups.

[3] T1: normal taping

[4] T3: 90° rotated taping

## 10. Revision history

**Table 10. Revision history**

| Document ID  | Release date | Data sheet status     | Change notice | Supersedes  |
|--|--------------|-----------------------|---------------|---|
| BC637_BCP55_BCX55_7  | 20070625     | Product data sheet    | -             | BC637_BCP55_BCX55_6                               |
| Modifications: <ul style="list-style-type: none"> <li>• The format of this data sheet has been redesigned to comply with the new identity guidelines of NXP Semiconductors.</li> <li>• Legal texts have been adapted to the new company name where appropriate.</li> <li>• <a href="#">Table 1 “Product overview”</a>: amended</li> <li>• <a href="#">Section 1.2 “Features”</a>: amended</li> <li>• <a href="#">Section 1.3 “Applications”</a>: amended</li> <li>• <a href="#">Table 2 “Quick reference data”</a>: I<sub>C</sub> parameter redefined to collector current</li> <li>• <a href="#">Table 2 “Quick reference data”</a>: I<sub>CM</sub> condition added</li> <li>• <a href="#">Figure 2</a> and <a href="#">3</a>: amended</li> <li>• <a href="#">Table 6 “Limiting values”</a>: I<sub>C</sub> parameter redefined to collector current</li> <li>• <a href="#">Table 6 “Limiting values”</a>: I<sub>CM</sub> condition added</li> <li>• <a href="#">Table 6 “Limiting values”</a>: P<sub>tot</sub> values for BCP55 and BCX55 adapted</li> <li>• <a href="#">Table 7 “Thermal characteristics”</a>: R<sub>th(j-a)</sub> values for BCP55 and BCX55 rounded</li> <li>• <a href="#">Figure 4</a>: Z<sub>th</sub> redefined to Z<sub>th(j-a)</sub> transient thermal impedance from junction to ambient</li> <li>• <a href="#">Figure 4</a>: t<sub>p</sub> parameter redefined to pulse duration</li> <li>• <a href="#">Figure 5</a>: added</li> <li>• <a href="#">Figure 6</a>: Z<sub>th</sub> redefined to Z<sub>th(j-a)</sub> transient thermal impedance from junction to ambient</li> <li>• <a href="#">Figure 6</a>: t<sub>p</sub> parameter redefined to pulse duration</li> <li>• <a href="#">Figure 7</a>: added</li> <li>• <a href="#">Figure 8</a>: Z<sub>th</sub> redefined to Z<sub>th(j-a)</sub> transient thermal impedance from junction to ambient</li> <li>• <a href="#">Figure 8</a>: t<sub>p</sub> parameter redefined to pulse duration</li> <li>• <a href="#">Figure 9</a>: added</li> <li>• <a href="#">Figure 11</a>: amended</li> <li>• <a href="#">Table 9 “Packing methods”</a>: new packing method for BCX55 added</li> <li>• <a href="#">Section 11 “Legal information”</a>: updated</li> </ul> |              |                       |               |   |
| BC637_BCP55_BCX55_6  | 20050218     | Product data sheet    | CPCN200405029 | BC635_637_639_4<br>BCP54_55_56_5<br>BCX54_55_56_4 |
| BC635_637_639_4  | 20011010     | Product specification | -             | BC635_637_639_3                                   |
| BCP54_55_56_5  | 20030206     | Product specification | -             | BCP54_55_56_4                                     |
| BCX54_55_56_4  | 20011010     | Product specification | -             | BCX54_55_56_3                                     |

## 11. Legal information

### 11.1 Data sheet status

| Document status <sup>[1][2]</sup> | Product status <sup>[3]</sup> | Definition  |
|-----------------------------------|-------------------------------|---|
| Objective [short] data sheet      | Development                   | This document contains data from the objective specification for product development. |
| Preliminary [short] data sheet    | Qualification                 | This document contains data from the preliminary specification.                       |
| Product [short] data sheet        | Production                    | This document contains the product specification.                                     |

[1] Please consult the most recently issued document before initiating or completing a design.

[2] The term 'short data sheet' is explained in section "Definitions".

[3] The product status of device(s) described in this document may have changed since this document was published and may differ in case of multiple devices. The latest product status information is available on the Internet at URL <http://www.nxp.com>.

### 11.2 Definitions

**Draft** — The document is a draft version only. The content is still under internal review and subject to formal approval, which may result in modifications or additions. NXP Semiconductors does not give any representations or warranties as to the accuracy or completeness of information included herein and shall have no liability for the consequences of use of such information.

**Short data sheet** — A short data sheet is an extract from a full data sheet with the same product type number(s) and title. A short data sheet is intended for quick reference only and should not be relied upon to contain detailed and full information. For detailed and full information see the relevant full data sheet, which is available on request via the local NXP Semiconductors sales office. In case of any inconsistency or conflict with the short data sheet, the full data sheet shall prevail.

### 11.3 Disclaimers

**General** — Information in this document is believed to be accurate and reliable. However, NXP Semiconductors does not give any representations or warranties, expressed or implied, as to the accuracy or completeness of such information and shall have no liability for the consequences of use of such information.

**Right to make changes** — NXP Semiconductors reserves the right to make changes to information published in this document, including without limitation specifications and product descriptions, at any time and without notice. This document supersedes and replaces all information supplied prior to the publication hereof.

**Suitability for use** — NXP Semiconductors products are not designed, authorized or warranted to be suitable for use in medical, military, aircraft, space or life support equipment, nor in applications where failure or

malfunction of a NXP Semiconductors product can reasonably be expected to result in personal injury, death or severe property or environmental damage. NXP Semiconductors accepts no liability for inclusion and/or use of NXP Semiconductors products in such equipment or applications and therefore such inclusion and/or use is at the customer's own risk.

**Applications** — Applications that are described herein for any of these products are for illustrative purposes only. NXP Semiconductors makes no representation or warranty that such applications will be suitable for the specified use without further testing or modification.

**Limiting values** — Stress above one or more limiting values (as defined in the Absolute Maximum Ratings System of IEC 60134) may cause permanent damage to the device. Limiting values are stress ratings only and operation of the device at these or any other conditions above those given in the Characteristics sections of this document is not implied. Exposure to limiting values for extended periods may affect device reliability.

**Terms and conditions of sale** — NXP Semiconductors products are sold subject to the general terms and conditions of commercial sale, as published at <http://www.nxp.com/profile/terms>, including those pertaining to warranty, intellectual property rights infringement and limitation of liability, unless explicitly otherwise agreed to in writing by NXP Semiconductors. In case of any inconsistency or conflict between information in this document and such terms and conditions, the latter will prevail.

**No offer to sell or license** — Nothing in this document may be interpreted or construed as an offer to sell products that is open for acceptance or the grant, conveyance or implication of any license under any copyrights, patents or other industrial or intellectual property rights.

### 11.4 Trademarks

Notice: All referenced brands, product names, service names and trademarks are the property of their respective owners.

## 12. Contact information

For additional information, please visit: <http://www.nxp.com>

For sales office addresses, send an email to: [salesaddresses@nxp.com](mailto:salesaddresses@nxp.com)

**13. Contents**

**1 Product profile . . . . . 1**

1.1 General description . . . . . 1

1.2 Features . . . . . 1

1.3 Applications . . . . . 1

1.4 Quick reference data . . . . . 1

**2 Pinning information . . . . . 2**

**3 Ordering information . . . . . 3**

**4 Marking . . . . . 3**

**5 Limiting values . . . . . 4**

**6 Thermal characteristics . . . . . 6**

**7 Characteristics . . . . . 9**

**8 Package outline . . . . . 11**

**9 Packing information . . . . . 12**

**10 Revision history . . . . . 13**

**11 Legal information . . . . . 14**

11.1 Data sheet status . . . . . 14

11.2 Definitions . . . . . 14

11.3 Disclaimers . . . . . 14

11.4 Trademarks . . . . . 14

**12 Contact information . . . . . 14**

**13 Contents . . . . . 15**

Please be aware that important notices concerning this document and the product(s) described herein, have been included in section 'Legal information'.



© NXP B.V. 2007.

All rights reserved.

For more information, please visit: <http://www.nxp.com>

For sales office addresses, please send an email to: [salesaddresses@nxp.com](mailto:salesaddresses@nxp.com)

Date of release: 25 June 2007

Document identifier: BC637\_BCP55\_BCX55\_7