



Micro Commercial Components

Micro Commercial Components  
 20736 Marilla Street Chatsworth  
 CA 91311  
 Phone: (818) 701-4933  
 Fax: (818) 701-4939

## Features

- Case Material: Molded Plastic. UL Flammability Classification Rating 94V-0 and MSL Rating 1
- Ideally Suited for Automatic Insertion
- 150°C Junction Temperature
- For Switching and AF Amplifier Applications
- Epitaxial Planar Die Construction

## Mechanical Data

- Case: SOT-23, Molded Plastic
- Terminals: Solderable per MIL-STD-202, Method 208
- Polarity: See Diagram
- Weight: 0.008 grams ( approx.)
- Marking: BC817-16            6A  
   BC817-25            6B  
   BC817-40            6C

## Maximum Ratings @ 25°C Unless Otherwise Specified

Charateristic	Symbol	Value	Unit
Collector-Emitter Voltage	$V_{CEO}$	45	V
Emitter-Base Voltage	$V_{EBO}$	5	V
Collector Current	$I_C$	800	mA
Peak Collector Current	$I_{CM}$	1000	mA
Peak Emitter Current	$I_{EM}$	1000	mA
Power Dissipation@ $T_s=50^\circ\text{C}$ (Note1)	$P_d$	310	mW
Operating & Storage Temperature	$T_j, T_{STG}$	-55~150	°C

**Note:** 1. Device mounted on Ceramic Substrate 0.7mm X 2.5cm<sup>2</sup> area

# BC817-16 THRU BC817-40

## NPN Small Signal Transistor 310mW

### SOT-23

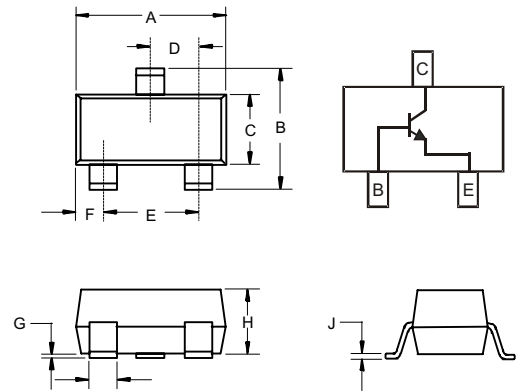

DIM	INCHES		MM		NOTE
	MIN	MAX	MIN	MAX	
A	.110	.120	2.80	3.04	
B	.083	.098	2.10	2.64	
C	.047	.055	1.20	1.40	
D	.035	.041	.89	1.03	
E	.070	.081	1.78	2.05	
F	.018	.024	.45	.60	
G	.0005	.0039	.013	.100	
H	.035	.044	.89	1.12	
J	.003	.007	.085	.180	
K	.015	.020	.37	.51	

### Suggested Solder Pad Layout

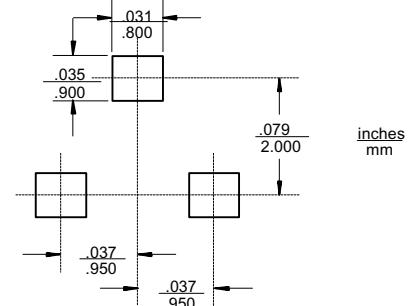

## Electrical Characteristics @25°C unless otherwise specified

Characteristic	Symbol	Min	Max	Unit	Test Condition
DC Current Gain	Current Gain Group -16 -25 -40	100	250	—	$V_{CE} = 1.0V, I_C = 100mA$
		160	400		$V_{CE} = 1.0V, I_C = 300mA$
	Current Gain Group -16 -25 -40	250	600	—	
		60	—		
		100	—		
		170	—		
Thermal Resistance, Junction to Substrate Backside	$R_{\theta SB}$	—	320	K/W	
Thermal Resistance, Junction to Ambient Air	$R_{\theta JA}$	—	400	K/W	
Collector-Emitter Saturation Voltage	$V_{CE(SAT)}$	—	0.7	V	$I_C = 500mA, I_B = 50mA$
Base-Emitter Voltage	$V_{BE}$	—	1.2	V	$V_{CE} = 1.0V, I_C = 300mA$
Collector-Emitter Cutoff Current	$I_{CES}$	—	100	nA	$V_{CE} = 45V$
		—	5.0	$\mu A$	$V_{CE} = 25V, T_J = 150^\circ C$
Emitter-Base Cutoff Current	$I_{EBO}$	—	100	nA	$V_{EB} = 4.0V$
Gain Bandwidth Product	$f_T$	100	—	MHz	$V_{CE} = 5.0V, I_C = 10mA, f = 50MHz$
Collector-Base Capacitance	$C_{CBO}$	—	12	pF	$V_{CB} = 10V, f = 1.0MHz$

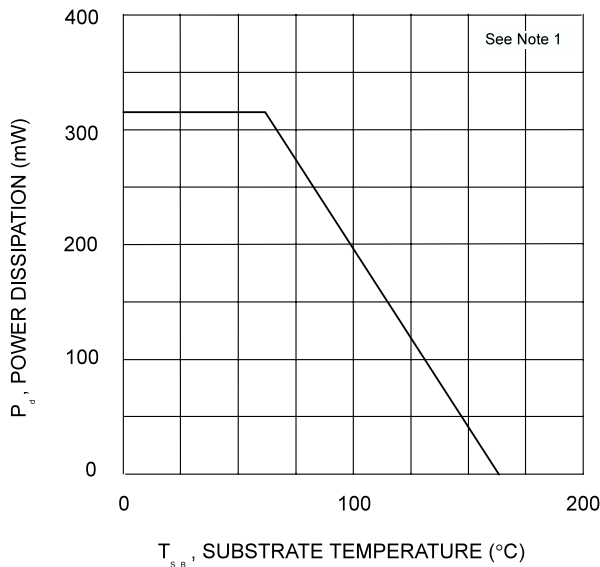

$T_{sB}$ , SUBSTRATE TEMPERATURE (°C)  
Fig. 1, Power Derating Curve

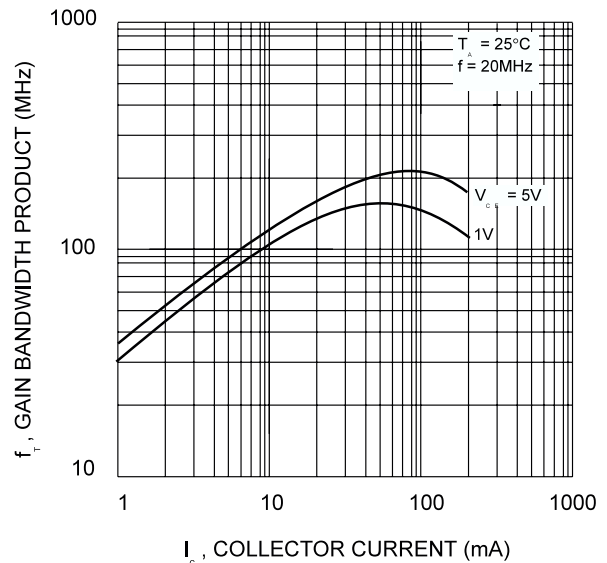

$I_c$ , COLLECTOR CURRENT (mA)  
Fig. 2, Gain-Bandwidth Product vs Collector Current

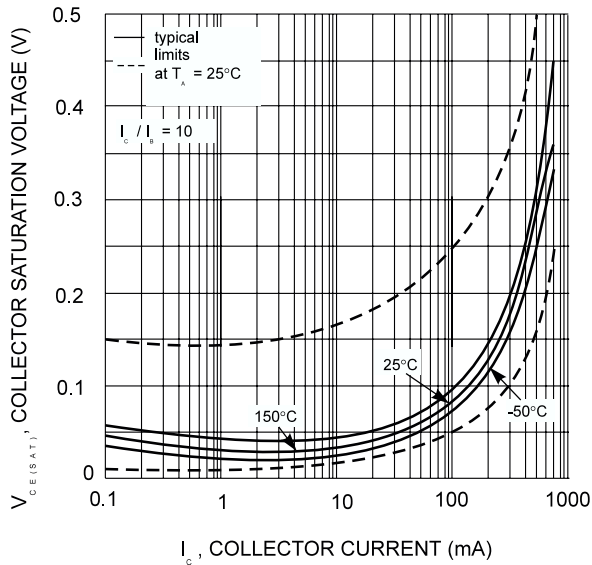

Fig. 3, Collector Sat. Voltage vs Collector Current

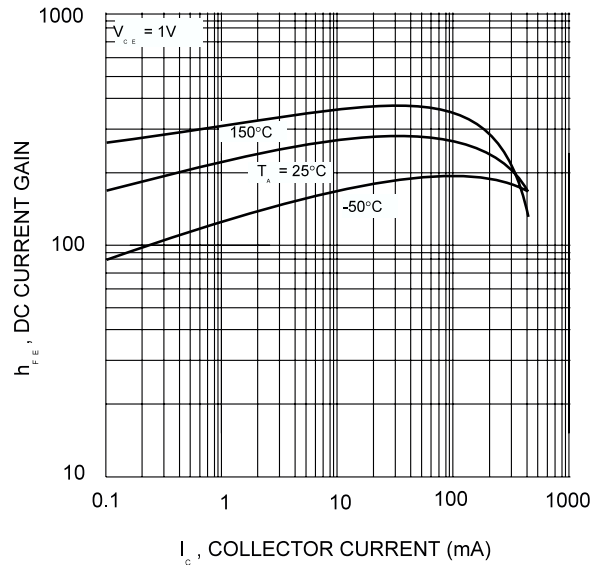

Fig. 4, DC Current Gain vs Collector Current

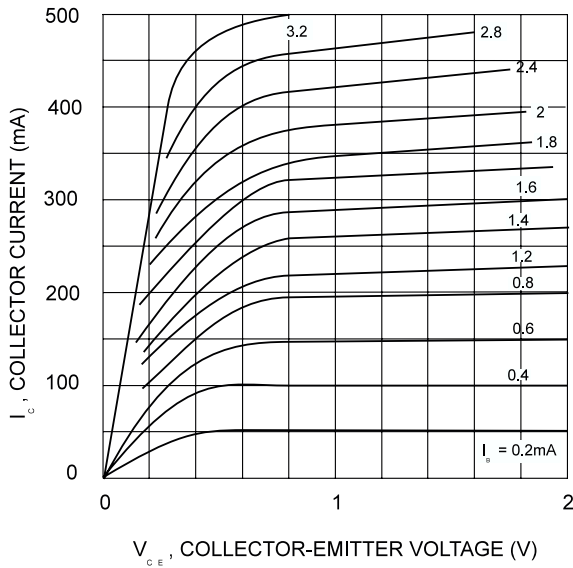

Fig. 5, Typical Emitter-Collector Characteristics

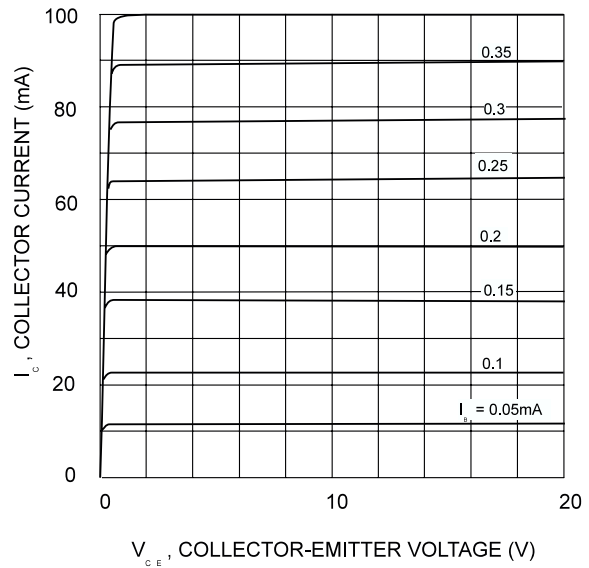

Fig. 6, Typical Emitter-Collector Characteristics



Micro Commercial Components

## Ordering Information

Device	Packing
(Part Number)-TP	Tape&Reel;3Kpcs/Reel

### \*\*\*IMPORTANT NOTICE\*\*\*

*Micro Commercial Components Corp.* reserves the right to make changes without further notice to any product herein to make corrections, modifications, enhancements, improvements, or other changes. *Micro Commercial Components Corp.* does not assume any liability arising out of the application or use of any product described herein; neither does it convey any license under its patent rights, nor the rights of others. The user of products in such applications shall assume all risks of such use and will agree to hold *Micro Commercial Components Corp.* and all the companies whose products are represented on our website, harmless against all damages.

### \*\*\*APPLICATIONS DISCLAIMER\*\*\*

Products offer by *Micro Commercial Components Corp.* are not intended for use in Medical, Aerospace or Military Applications.