

Small Signal Product

300mW, NPN Small Signal Transistor
FEATURES

- Low power loss, high current capability, low VF
- Surface mount device type
- Moisture sensitivity level 1
- Matte Tin(Sn) lead finish with Nickel(Ni) underplate
- Pb free and RoHS compliant
- Packing code with suffix "G" means green compound (halogen-free)

SOT-23

MECHANICAL DATA

- Case: SOT- 23 small outline plastic package
- Terminal: Matte tin plated, lead free, solderable per MIL-STD-202, Method 208 guaranteed
- High temperature soldering guaranteed: 260°C/10s
- Weight: 8mg (approximately)

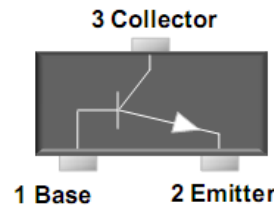

MAXIMUM RATINGS AND ELECTRICAL CHARACTERISTICS (T _A =25°C unless otherwise noted)			
PARAMETER	SYMBOL	VALUE	UNIT
Power dissipation	P _D	300	mW
Collector-Base Voltage	V _{CB0}	50	V
Collector-Emitter Voltage	V _{CEO}	45	V
Emitter-Base Voltage	V _{EBO}	5	V
Collector Current	I _C	500	mA
Thermal Resistance (Junction to Ambient)	R _{θJA}	417	°C
Junction Temperature	T _J	150	°C
Storage Temperature Range	T _{STG}	-55 to +150	°C

Notes: 1. Valid provided that electrodes are kept at ambient temperature

PARAMETER		SYMBOL	BC817-16	BC817-25	BC817-40	UNIT
Collector-Base Breakdown Voltage	I _C = 10μA I _E = 0	V _{(BR)CBO}	50			V
Collector-Emitter Breakdown Voltage	I _C = 10mA I _B = 0	V _{(BR)CEO}	45			V
Emitter-Base Breakdown Voltage	I _E = 1μA I _C = 0	V _{(BR)EBO}	5			V
Collector Cut-off Current	V _{CB} = 45V I _E = 0	I _{CBO}	0.1			μA
Emitter Cut-off Current	V _{EB} = 4V I _C = 0	I _{EBO}	0.1			μA
Collector-Emitter Saturation Voltage	I _C = 500mA I _B = 50 mA	V _{CE(sat)}	0.7			V
Base-Emitter Saturation Voltage	I _C = 500mA I _B = 50 mA	V _{BE(sat)}	1.2			V
Transition Frequency	V _{CE} = 5V I _C = 10mA f= 100MHz	f _T	100			MHz
Junction Capacitance	V _{CB} =10V f= 1.0MHz	C _{CBO}	10			pF
DC Current Gain	V _{CE} = 1V I _C = 100mA	h _{FE}	100	400	600	
	V _{CE} = 1V I _C = 100mA		>40	160	250	
DC Current Gain		h _{FE}	100-250	160-400	250-600	
Min. DC Current Gain	V _{ce} =1V I _c =500mA	h _{FE}	40			

Small Signal Product

RATINGS AND CHARACTERISTICS CURVES

($T_A=25^\circ\text{C}$ unless otherwise noted)

Fig.1 Typical Pulsed Current Gain VS.

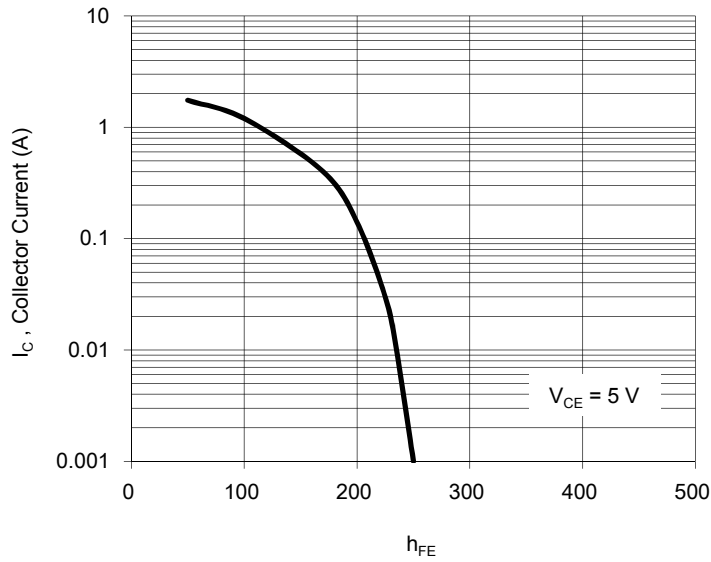

Fig. 2 Collector-Emitter Saturation Voltage VS. Collector Current

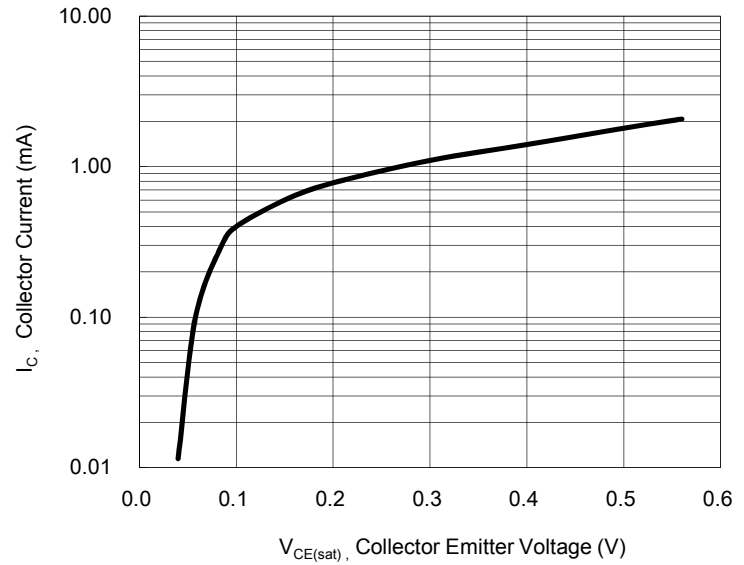

Fig. 3 Base-Emitter Saturation Voltage VS. Collector Current

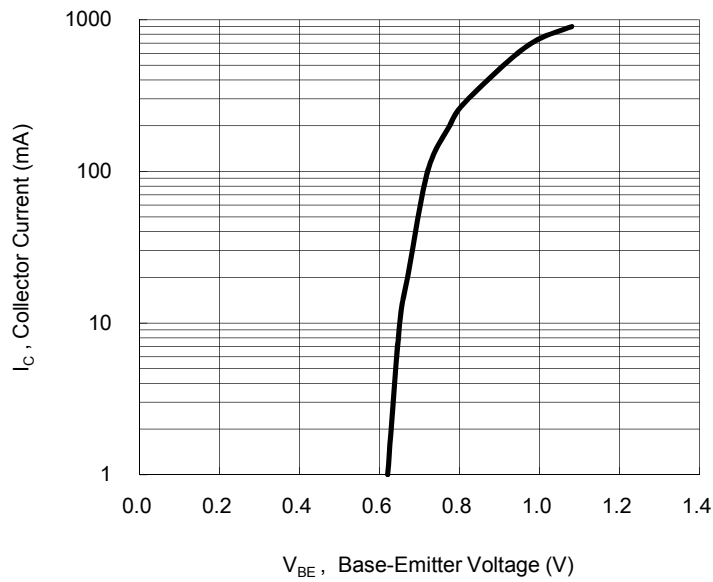

Fig. 4 Base-Emitter On Voltage VS. Collector Current

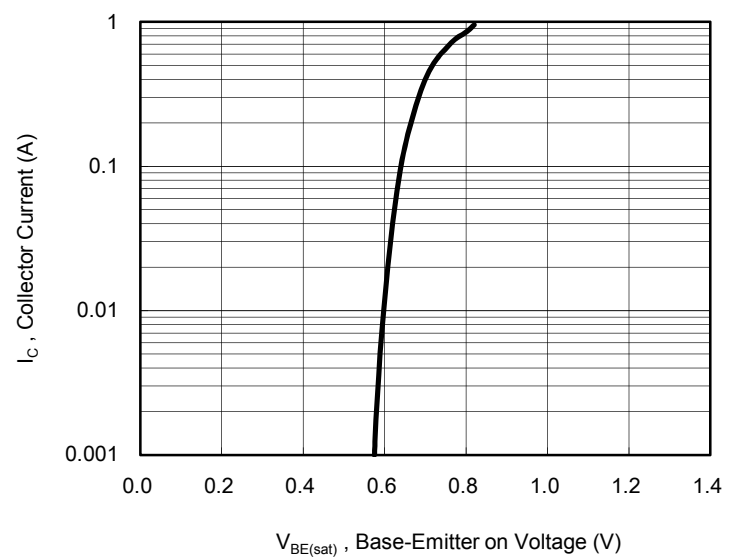
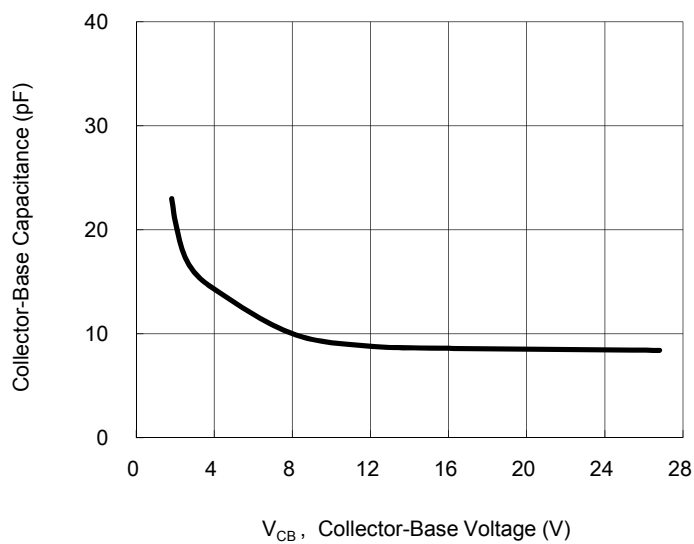

Fig. 5 Collector-Base Capacitance VS. Collector-Base Voltage



Small Signal Product

ORDER INFORMATION (EXAMPLE)

BC817-16 RFG

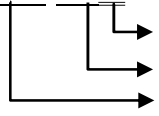

Green compound code
Packing code
Part no.

PACKAGE OUTLINE DIMENSIONS

SOT-23

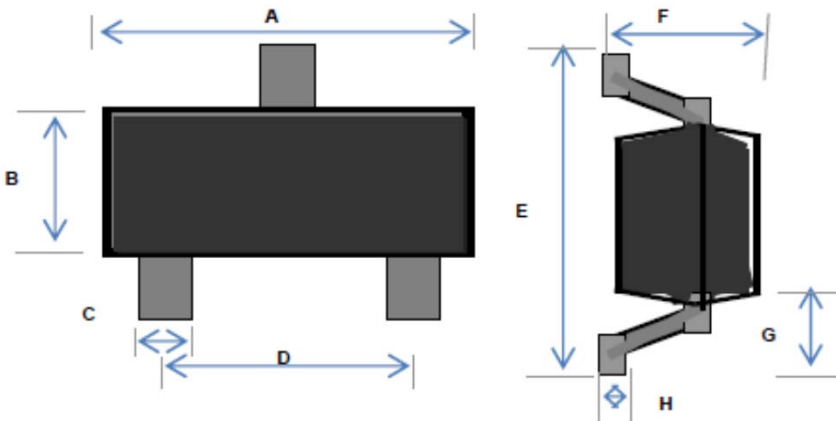

DIM.	Unit (mm)		Unit (inch)	
	Min	Max	Min	Max
A	2.70	3.10	0.106	0.122
B	1.10	1.50	0.043	0.059
C	0.30	0.51	0.012	0.020
D	1.78	2.04	0.070	0.080
E	2.10	2.64	0.083	0.104
F	0.89	1.30	0.035	0.051
G	0.55 REF		0.022 REF	
H	0.10 REF		0.004 REF	

SUGGEST PAD LAYOUT

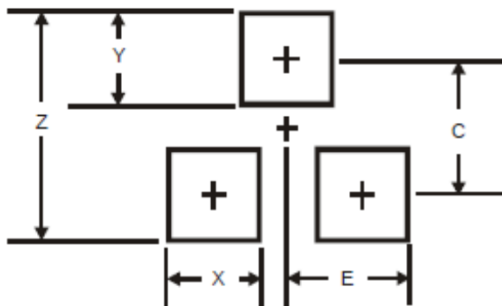

DIM	Unit (mm)	Unit (inch)
	TYP	TYP
Z	2.8	0.11
X	0.7	0.03
Y	0.9	0.04
C	1.9	0.07
E	1.0	0.04

MARKING

Part No.	Marking
BC817-16	6A
BC817-25	6B
BC817-40	6C

Notice

Specifications of the products displayed herein are subject to change without notice. TSC or anyone on its behalf, assumes no responsibility or liability for any errors or inaccuracies.

Information contained herein is intended to provide a product description only. No license, express or implied, to any intellectual property rights is granted by this document. Except as provided in TSC's terms and conditions of sale for such products, TSC assumes no liability whatsoever, and disclaims any express or implied warranty, relating to sale and/or use of TSC products including liability or warranties relating to fitness for a particular purpose, merchantability, or infringement of any patent, copyright, or other intellectual property right.

The products shown herein are not designed for use in medical, life-saving, or life-sustaining applications. Customers using or selling these products for use in such applications do so at their own risk and agree to fully indemnify TSC for any damages resulting from such improper use or sale.