

## Descriptions

- General purpose application
- Switching application

## Features

- High Voltage :  $V_{CEO}=55V$
- Complementary pair with BC856U

## Ordering Information

Type NO.	Marking	Package Code
BC846U	AS □ □ ① ② ③	SOT-323

①Device Code ②hFE Rank ③Year&Week Code

## PIN Connection

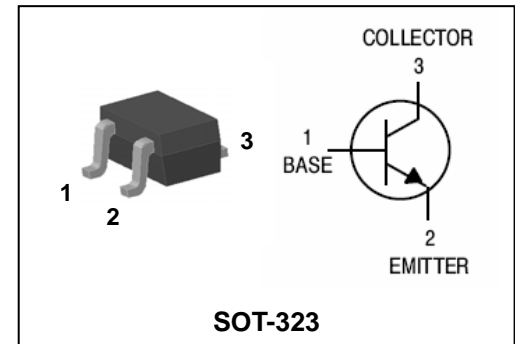

## Absolute maximum ratings

( $T_a=25^{\circ}C$ )

Characteristic	Symbol	Ratings	Unit
Collector-Base voltage	$V_{CBO}$	80	V
Collector-Emitter voltage	$V_{CEO}$	55	V
Emitter-Base voltage	$V_{EBO}$	5	V
Collector current	$I_C$	100	mA
Collector dissipation	$P_C$	200	mW
Junction temperature	$T_j$	150	$^{\circ}C$
Storage temperature	$T_{stg}$	-55 ~ 150	$^{\circ}C$

## Electrical Characteristics

( $T_a=25^{\circ}C$ )

Characteristic	Symbol	Test Condition	Min.	Typ.	Max.	Unit
Collector-Emitter breakdown voltage	$BV_{CEO}$	$I_C=1mA, I_B=0$	55	-	-	V
Base-Emitter turn on voltage	$V_{BE(ON)}$	$V_{CE}=5V, I_C=2mA$	550	-	700	mV
Base-Emitter saturation voltage	$V_{BE(sat)}$	$I_C=100mA, I_B=5mA$	-	900	-	mV
Collector-Emitter saturation voltage	$V_{CE(sat)}$	$I_C=100mA, I_B=5mA$	-	-	600	mV
Collector cut-off current	$I_{CBO}$	$V_{CB}=35V, I_E=0$	-	-	15	nA
DC current gain	$h_{FE}^*$	$V_{CE}=5V, I_C=2mA$	110	-	800	-
Transition frequency	$f_T$	$V_{CE}=5V, I_C=10mA$	-	150	-	MHz
Collector output capacitance	$C_{ob}$	$V_{CB}=10V, I_E=0, f=1MHz$	-	-	4.5	pF
Noise figure	NF	$V_{CE}=5V, I_C=200\mu A, f=1KHz, R_g=2K\Omega$	-	-	10	dB

\* :  $h_{FE}$  rank / A : 110 ~ 220, B : 200 ~ 450, C : 420 ~ 800

Electrical Characteristic Curves

Fig. 1  $P_C - T_a$

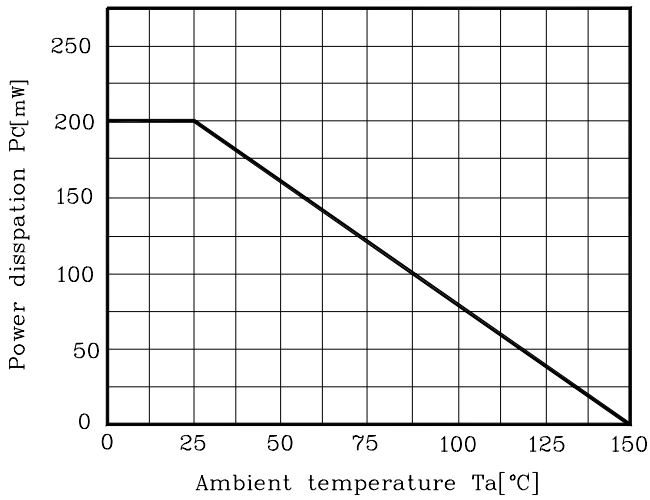

Fig. 2  $I_C - V_{BE}$

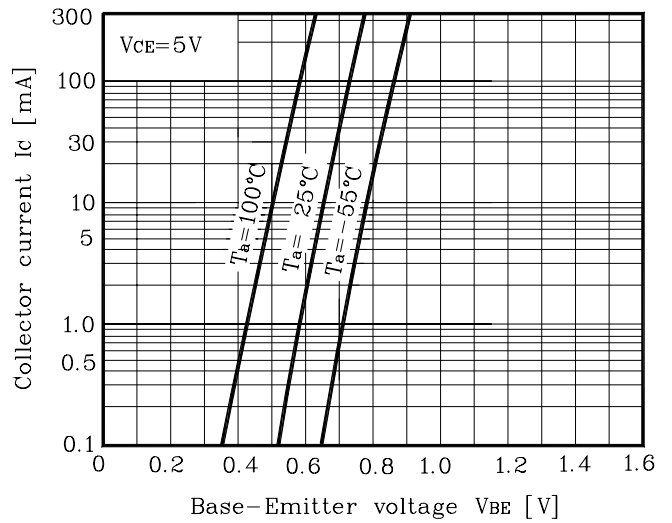

Fig. 3  $I_C - V_{CE}$

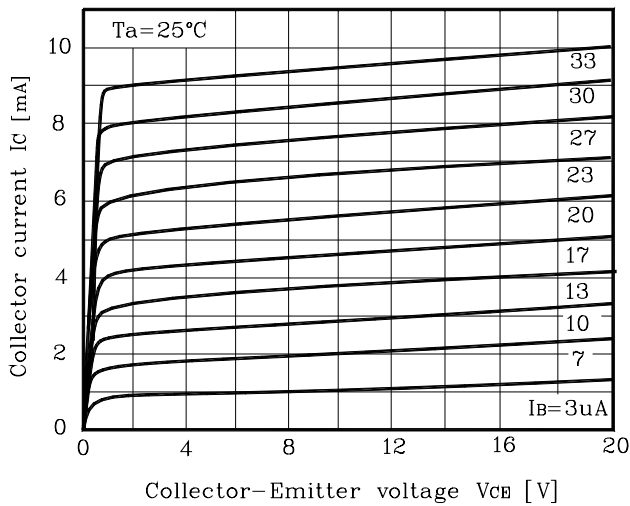

Fig. 4  $h_{FE} - I_C$

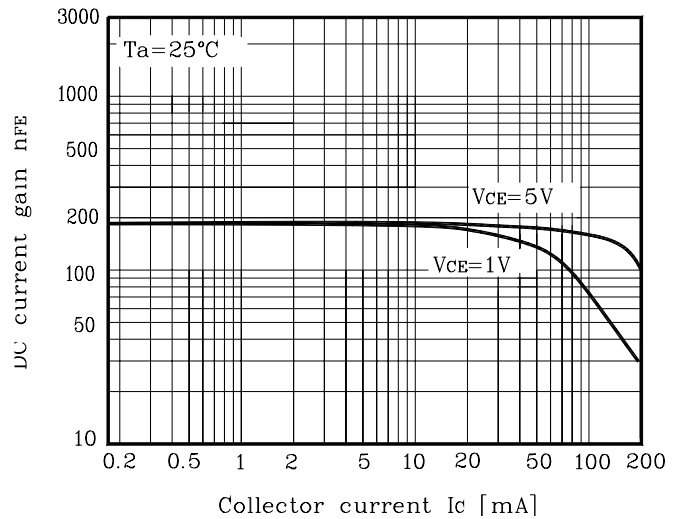
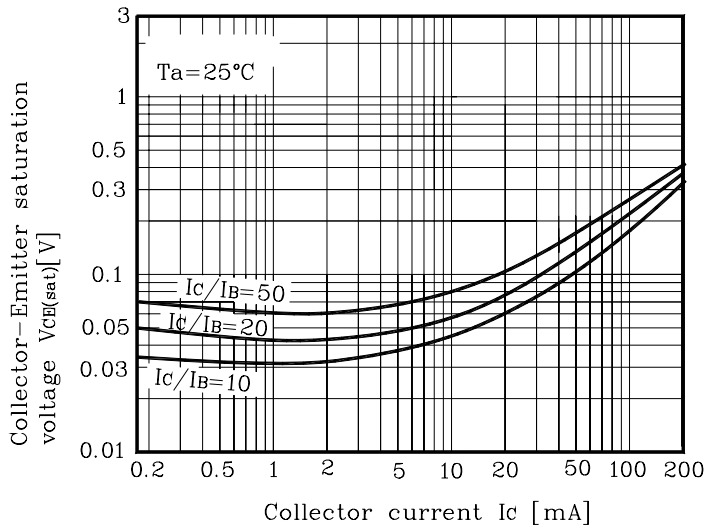
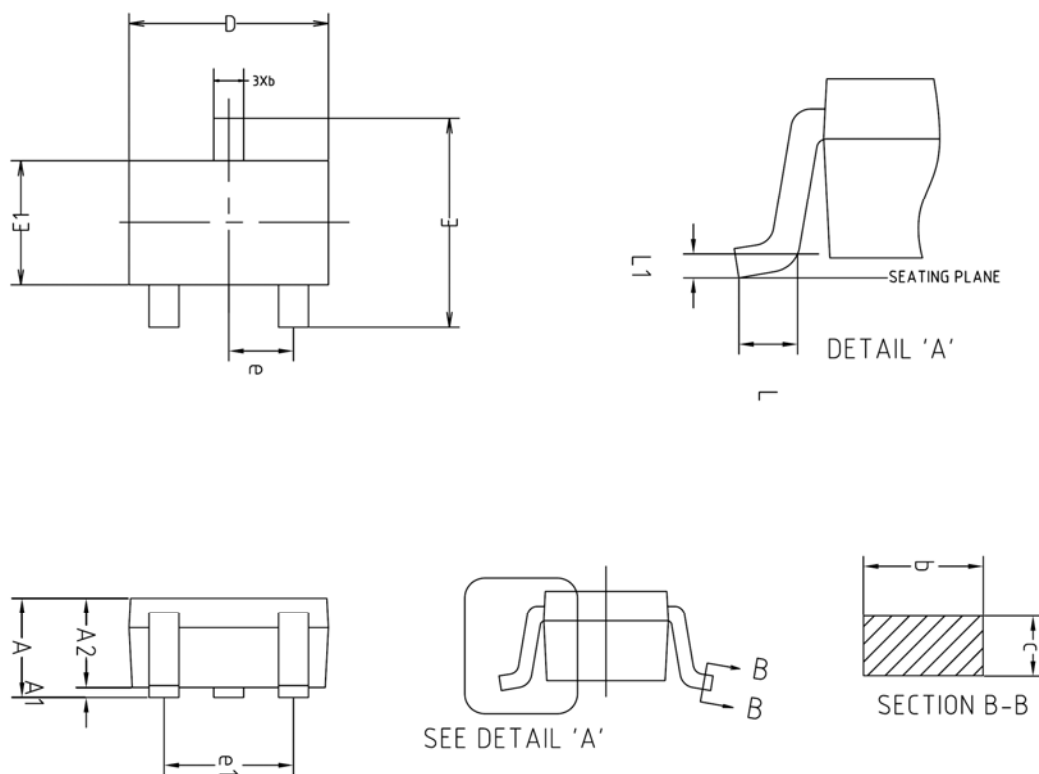

Fig. 5  $V_{CE(sat)} - I_C$



Outline Dimension



SYMBOL	MILLIMETERS			NOTE
	MINIMUM	NOMINAL	MAXIMUM	
A	0.90	-	1.25	
A1	0.00	-	0.10	
A2	0.85	0.90	0.95	
b	0.30	-	0.40	
c	0.10	-	0.25	
D	1.90	2.00	2.10	
E	1.95	2.10	2.25	
E1	1.15	1.25	1.35	
e	0.65BSC			
e1	1.20	-	1.40	
L	0.10	-	-	
L1	0.12BSC			

※Recommend PCB solder land [Unit: mm]

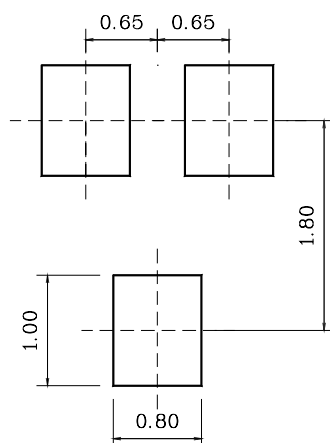

**The AUK Corp. products are intended for the use as components in general electronic equipment (Office and communication equipment, measuring equipment, home appliance, etc.).**

**Please make sure that you consult with us before you use these AUK Corp. products in equipments which require high quality and / or reliability, and in equipments which could have major impact to the welfare of human life(atomic energy control, airplane, spaceship, transportation, combustion control, all types of safety device, etc.). AUK Corp. cannot accept liability to any damage which may occur in case these AUK Corp. products were used in the mentioned equipments without prior consultation with AUK Corp..**

**Specifications mentioned in this publication are subject to change without notice.**