

BC847 series

45 V, 100 mA NPN general-purpose transistors

Rev. 8 — 20 August 2012

Product data sheet

1. Product profile

1.1 General description

NPN general-purpose transistors in Surface-Mounted Device (SMD) plastic packages.

Table 1. Product overview

Type number ^[1]	Package			PNP complement
	NXP	JEITA	JEDEC	
BC847	SOT23	-	TO-236AB	BC857
BC847A				BC857A
BC847B				BC857B
BC847C				BC857C
BC847W	SOT323	SC-70	-	BC857W
BC847AW				BC857AW
BC847BW				BC857BW
BC847CW				BC857CW
BC847T	SOT416	SC-75	-	BC857T
BC847AT				BC857AT
BC847BT				BC857BT
BC847CT				BC857CT
BC847AM	SOT883	SC-101	-	BC857AM
BC847BM				BC857BM
BC847CM				BC857CM

[1] Valid for all available selection groups.

1.2 Features and benefits

- General-purpose transistors
- SMD plastic packages
- Three different gain selections

1.3 Applications

- General-purpose switching and amplification



1.4 Quick reference data

Table 2. Quick reference data

Symbol	Parameter	Conditions	Min	Typ	Max	Unit
V_{CE0}	collector-emitter voltage	open base	-	-	45	V
I_C	collector current		-	-	100	mA
h_{FE}	DC current gain	$V_{CE} = 5\text{ V}; I_C = 2\text{ mA}$	110	-	800	
	h_{FE} group A		110	180	220	
	h_{FE} group B		200	290	450	
	h_{FE} group C		420	520	800	

2. Pinning information

Table 3. Pinning

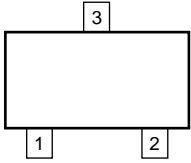
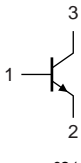
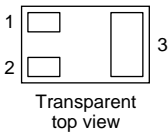
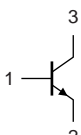
Pin	Description	Simplified outline	Graphic symbol
SOT23, SOT323, SOT416			
1	base	 <p>006aaa144</p>	 <p>sym021</p>
2	emitter		
3	collector		
SOT883			
1	base	 <p>Transparent top view</p>	 <p>sym021</p>
2	emitter		
3	collector		

3. Ordering information

Table 4. Ordering information

Type number ^[1]	Package		
	Name	Description	Version
BC847	-	plastic surface-mounted package; 3 leads	SOT23
BC847A			
BC847B			
BC847C			
BC847W	SC-70	plastic surface-mounted package; 3 leads	SOT323
BC847AW			
BC847BW			
BC847CW			
BC847T	SC-75	plastic surface-mounted package; 3 leads	SOT416
BC847AT			
BC847BT			
BC847CT			
BC847AM	SC-101	leadless ultra small plastic package; 3 solder lands; body 1.0 × 0.6 × 0.5 mm	SOT883
BC847BM			
BC847CM			

[1] Valid for all available selection groups.

4. Marking

Table 5. Marking codes

Type number	Marking code ^[1]	Type number	Marking code ^[1]
BC847	1H*	BC847T	1N
BC847A	1E*	BC847AT	1E
BC847B	1F*	BC847BT	1F
BC847C	1G*	BC847CT	1G
BC847W	1H*	BC847AM	D4
BC847AW	1E*	BC847BM	D5
BC847BW	1F*	BC847CM	D6
BC847CW	1G*		

[1] * = placeholder for manufacturing site code

5. Limiting values

Table 6. Limiting values

In accordance with the Absolute Maximum Rating System (IEC 60134).

Symbol	Parameter	Conditions	Min	Max	Unit
V_{CBO}	collector-base voltage	open emitter	-	50	V
V_{CEO}	collector-emitter voltage	open base	-	45	V
V_{EBO}	emitter-base voltage	open collector	-	6	V
I_C	collector current		-	100	mA
I_{CM}	peak collector current	single pulse; $t_p \leq 1$ ms	-	200	mA
I_{BM}	peak base current	single pulse; $t_p \leq 1$ ms	-	100	mA
P_{tot}	total power dissipation	$T_{amb} \leq 25$ °C	[1]		
	SOT23		-	250	mW
	SOT323		-	200	mW
	SOT416		-	150	mW
	SOT883		[2]	250	mW
T_j	junction temperature		-	150	°C
T_{amb}	ambient temperature		-65	+150	°C
T_{stg}	storage temperature		-65	+150	°C

[1] Device mounted on an FR4 Printed-Circuit Board (PCB), single-sided copper, tin-plated and standard footprint.

[2] Device mounted on an FR4 PCB with 60 μ m copper strip line, standard footprint.

6. Thermal characteristics

Table 7. Thermal characteristics

Symbol	Parameter	Conditions	Min	Typ	Max	Unit
$R_{th(j-a)}$	thermal resistance from junction to ambient	in free air	[1]			
	SOT23		-	-	500	K/W
	SOT323		-	-	625	K/W
	SOT416		-	-	833	K/W
	SOT883		[2]	-	500	K/W

[1] Device mounted on an FR4 PCB, single-sided copper, tin-plated and standard footprint.

[2] Device mounted on an FR4 PCB with 60 μ m copper strip line, standard footprint.

7. Characteristics

Table 8. Characteristics
 $T_{amb} = 25\text{ }^{\circ}\text{C}$ unless otherwise specified.

Symbol	Parameter	Conditions	Min	Typ	Max	Unit	
I_{CBO}	collector-base cut-off current	$V_{CB} = 30\text{ V}; I_E = 0\text{ A}$	-	-	15	nA	
		$V_{CB} = 30\text{ V}; I_E = 0\text{ A}; T_j = 150\text{ }^{\circ}\text{C}$	-	-	5	μA	
I_{EBO}	emitter-base cut-off current	$V_{EB} = 5\text{ V}; I_C = 0\text{ A}$	-	-	100	nA	
h_{FE}	DC current gain	$V_{CE} = 5\text{ V}; I_C = 10\text{ }\mu\text{A}$					
	h_{FE} group A		-	90	-		
	h_{FE} group B		-	150	-		
	h_{FE} group C		-	270	-		
	DC current gain	$V_{CE} = 5\text{ V}; I_C = 2\text{ mA}$	110	-	800		
	h_{FE} group A		110	180	220		
	h_{FE} group B		200	290	450		
V_{CEsat}	collector-emitter saturation voltage	$I_C = 10\text{ mA}; I_B = 0.5\text{ mA}$	-	90	200	mV	
		$I_C = 100\text{ mA}; I_B = 5\text{ mA}$	[1]	-	200	400	mV
V_{BEsat}	base-emitter saturation voltage	$I_C = 10\text{ mA}; I_B = 0.5\text{ mA}$	[2]	-	700	-	mV
		$I_C = 100\text{ mA}; I_B = 5\text{ mA}$	[2]	-	900	-	mV
V_{BE}	base-emitter voltage	$I_C = 2\text{ mA}; V_{CE} = 5\text{ V}$	[2]	580	660	700	mV
		$I_C = 10\text{ mA}; V_{CE} = 5\text{ V}$	-	-	770	mV	
f_T	transition frequency	$V_{CE} = 5\text{ V}; I_C = 10\text{ mA}; f = 100\text{ MHz}$	100	-	-	MHz	
C_c	collector capacitance	$V_{CB} = 10\text{ V}; I_E = i_e = 0\text{ A}; f = 1\text{ MHz}$	-	-	1.5	pF	
C_e	emitter capacitance	$V_{EB} = 0.5\text{ V}; I_C = i_c = 0\text{ A}; f = 1\text{ MHz}$	-	11	-	pF	
NF	noise figure	$I_C = 200\text{ }\mu\text{A}; V_{CE} = 5\text{ V}; R_S = 2\text{ k}\Omega; f = 1\text{ kHz}; B = 200\text{ Hz}$	-	2	10	dB	

[1] Pulse test: $t_p \leq 300\text{ }\mu\text{s}; \delta = 0.02$.

[2] V_{BE} decreases by approximately 2 mV/K with increasing temperature.

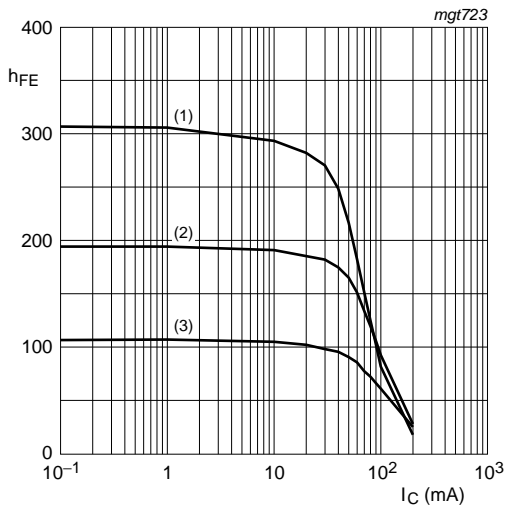

$V_{CE} = 5\text{ V}$
 (1) $T_{amb} = 150\text{ °C}$
 (2) $T_{amb} = 25\text{ °C}$
 (3) $T_{amb} = -55\text{ °C}$

Fig 1. Group A: DC current gain as a function of collector current; typical values

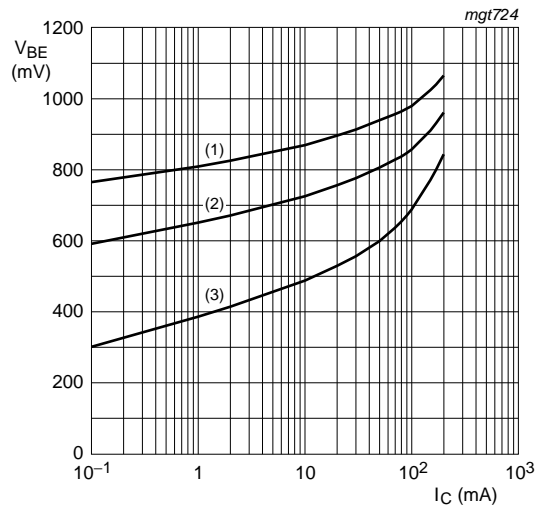

$V_{CE} = 5\text{ V}$
 (1) $T_{amb} = -55\text{ °C}$
 (2) $T_{amb} = 25\text{ °C}$
 (3) $T_{amb} = 150\text{ °C}$

Fig 2. Group A: Base-emitter voltage as a function of collector current; typical values

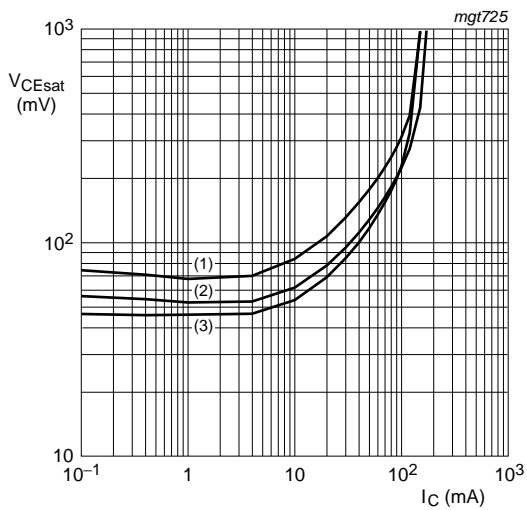

$I_C/I_B = 20$
 (1) $T_{amb} = 150\text{ °C}$
 (2) $T_{amb} = 25\text{ °C}$
 (3) $T_{amb} = -55\text{ °C}$

Fig 3. Group A: Collector-emitter saturation voltage as a function of collector current; typical values

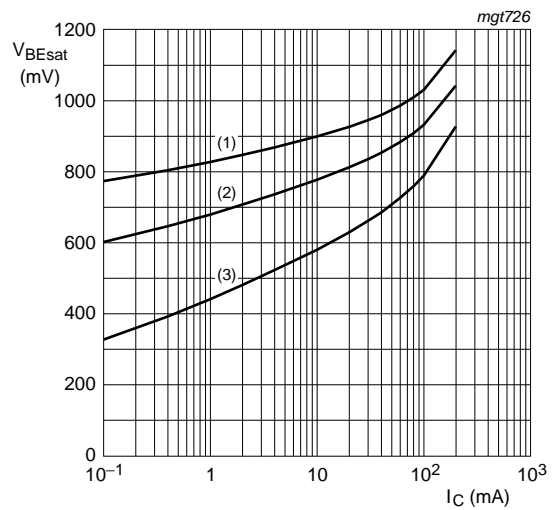

$I_C/I_B = 10$
 (1) $T_{amb} = -55\text{ °C}$
 (2) $T_{amb} = 25\text{ °C}$
 (3) $T_{amb} = 150\text{ °C}$

Fig 4. Group A: Base-emitter saturation voltage as a function of collector current; typical values

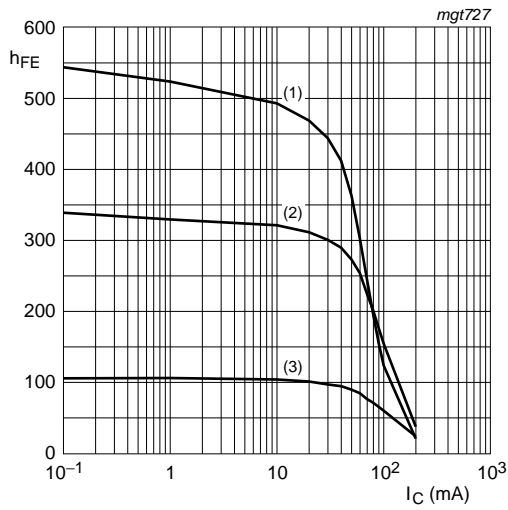

$V_{CE} = 5\text{ V}$
 (1) $T_{amb} = 150\text{ }^{\circ}\text{C}$
 (2) $T_{amb} = 25\text{ }^{\circ}\text{C}$
 (3) $T_{amb} = -55\text{ }^{\circ}\text{C}$

Fig 5. Group B: DC current gain as a function of collector current; typical values

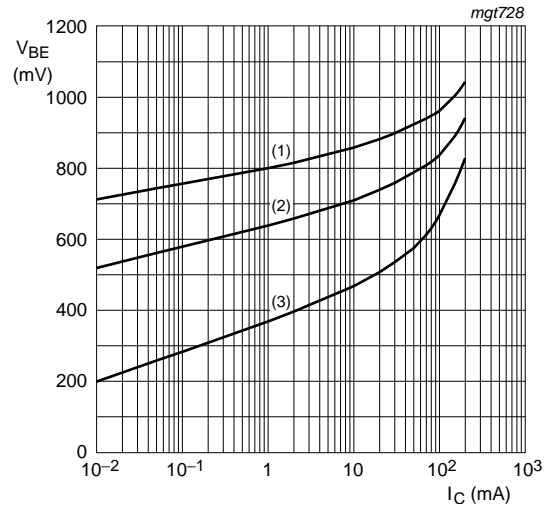

$V_{CE} = 5\text{ V}$
 (1) $T_{amb} = -55\text{ }^{\circ}\text{C}$
 (2) $T_{amb} = 25\text{ }^{\circ}\text{C}$
 (3) $T_{amb} = 150\text{ }^{\circ}\text{C}$

Fig 6. Group B: Base-emitter voltage as a function of collector current; typical values

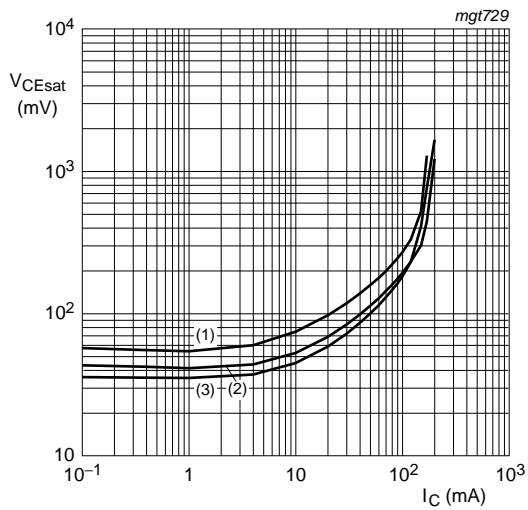

$I_C/I_B = 20$
 (1) $T_{amb} = 150\text{ }^{\circ}\text{C}$
 (2) $T_{amb} = 25\text{ }^{\circ}\text{C}$
 (3) $T_{amb} = -55\text{ }^{\circ}\text{C}$

Fig 7. Group B: Collector-emitter saturation voltage as a function of collector current; typical values

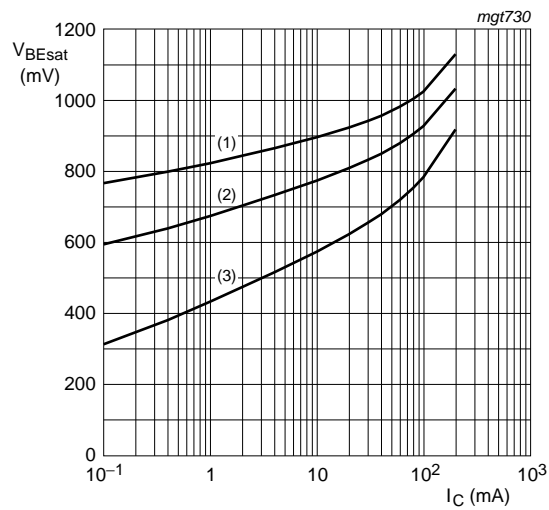

$I_C/I_B = 10$
 (1) $T_{amb} = -55\text{ }^{\circ}\text{C}$
 (2) $T_{amb} = 25\text{ }^{\circ}\text{C}$
 (3) $T_{amb} = 150\text{ }^{\circ}\text{C}$

Fig 8. Group B: Base-emitter saturation voltage as a function of collector current; typical values

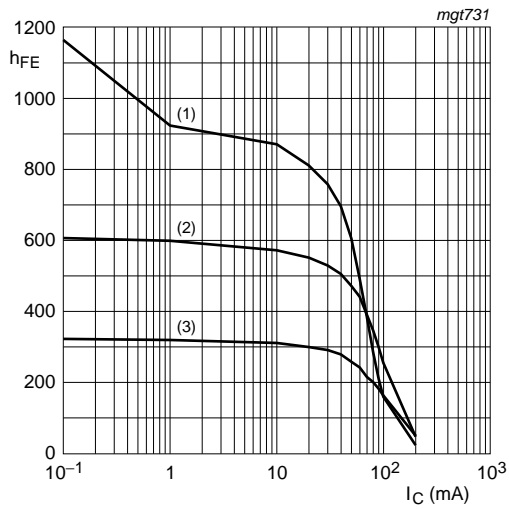

$V_{CE} = 5\text{ V}$
 (1) $T_{amb} = 150\text{ °C}$
 (2) $T_{amb} = 25\text{ °C}$
 (3) $T_{amb} = -55\text{ °C}$

Fig 9. Group C: DC current gain as a function of collector current; typical values

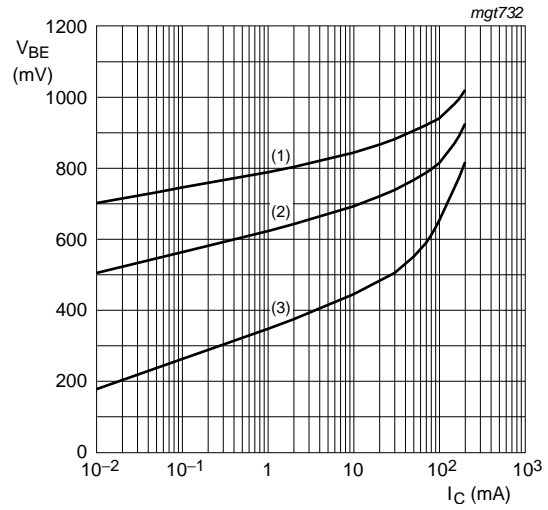

$V_{CE} = 5\text{ V}$
 (1) $T_{amb} = -55\text{ °C}$
 (2) $T_{amb} = 25\text{ °C}$
 (3) $T_{amb} = 150\text{ °C}$

Fig 10. Group C: Base-emitter voltage as a function of collector current; typical values

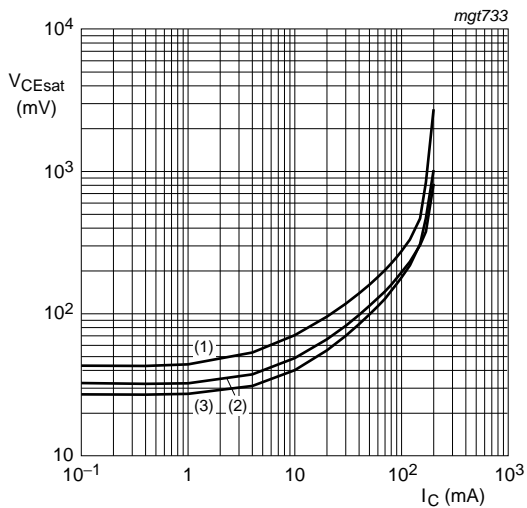

$I_C/I_B = 20$
 (1) $T_{amb} = 150\text{ °C}$
 (2) $T_{amb} = 25\text{ °C}$
 (3) $T_{amb} = -55\text{ °C}$

Fig 11. Group C: Collector-emitter saturation voltage as a function of collector current; typical values

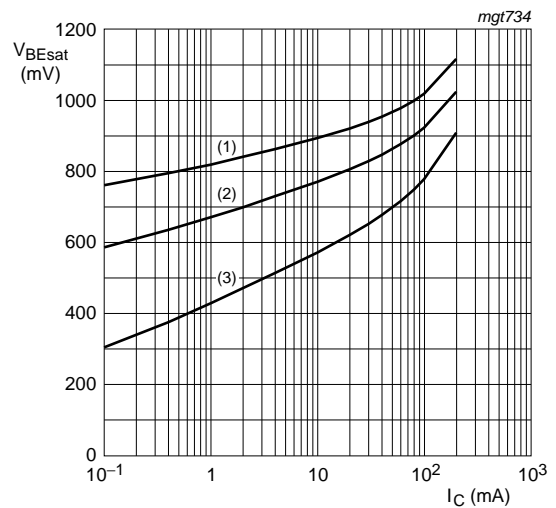

$I_C/I_B = 10$
 (1) $T_{amb} = -55\text{ °C}$
 (2) $T_{amb} = 25\text{ °C}$
 (3) $T_{amb} = 150\text{ °C}$

Fig 12. Group C: Base-emitter saturation voltage as a function of collector current; typical values

8. Package outline

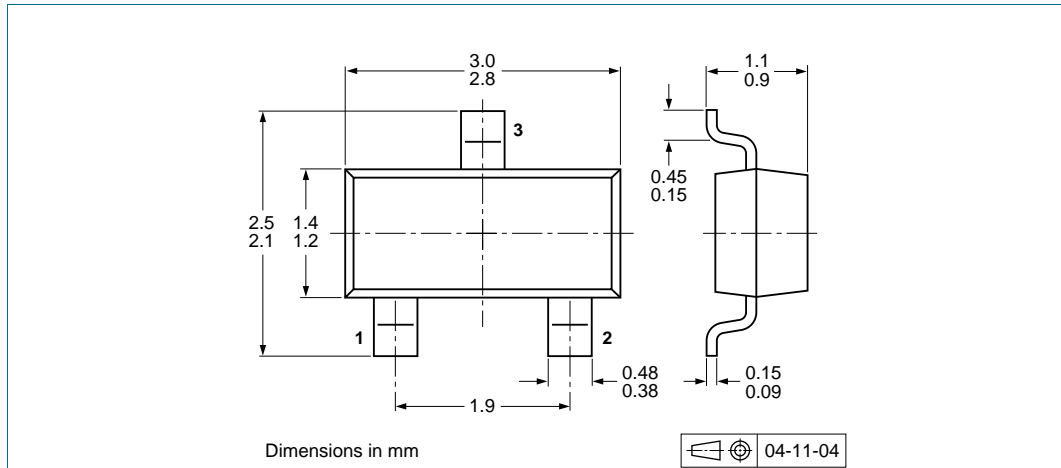

Fig 13. Package outline SOT23 (TO-236AB)

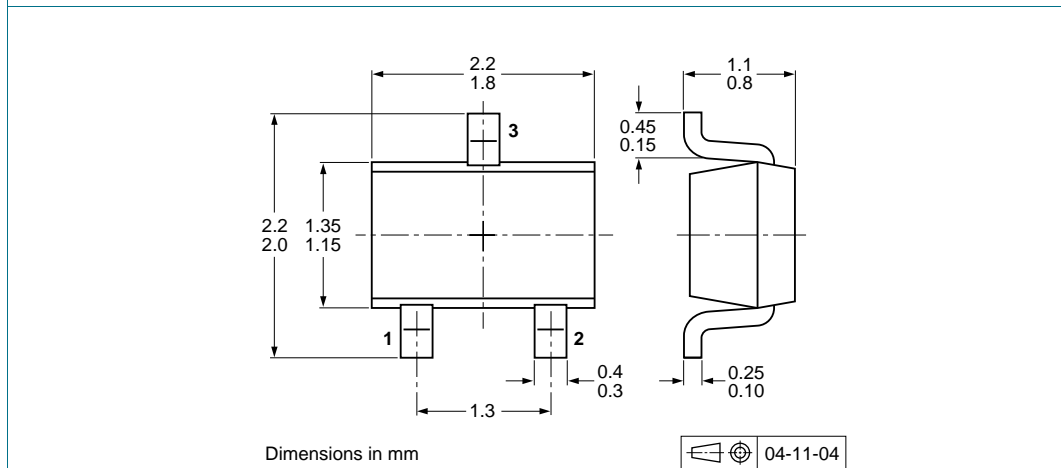

Fig 14. Package outline SOT323 (SC-70)

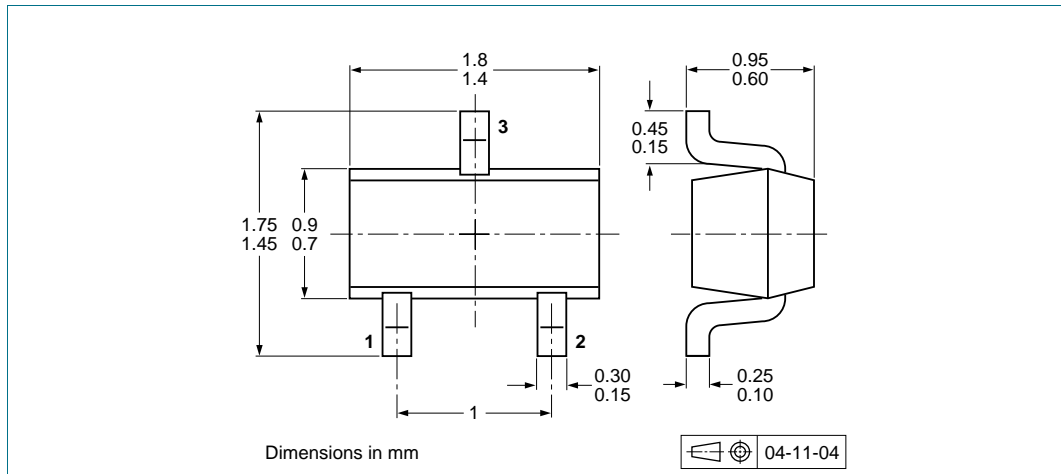

Fig 15. Package outline SOT416 (SC-75)

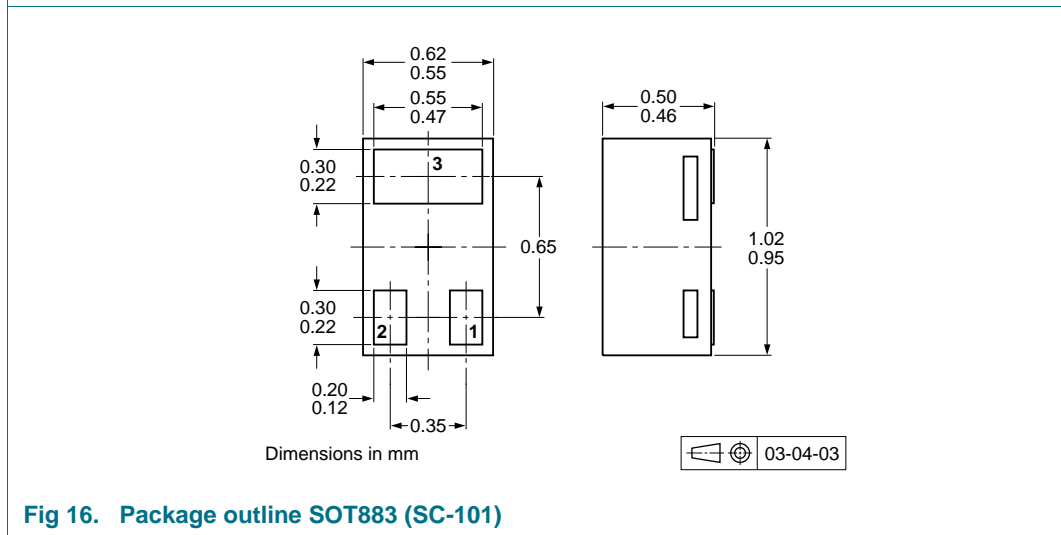

Fig 16. Package outline SOT883 (SC-101)

9. Packing information

Table 9. Packing methods

The indicated -xxx are the last three digits of the 12NC ordering code.^[1]

Type number ^[2]	Package	Description	Packing quantity		
			3000	5000	10000
BC847	SOT23	4 mm pitch, 8 mm tape and reel	-215	-	-235
BC847A					
BC847B					
BC847C					
BC847W	SOT323	4 mm pitch, 8 mm tape and reel	-115	-	-135
BC847AW					
BC847BW					
BC847CW					
BC847T	SOT416	4 mm pitch, 8 mm tape and reel	-115	-	-135
BC847AT					
BC847BT					
BC847CT					
BC847AM	SOT883	2 mm pitch, 8 mm tape and reel	-	-	-315
BC847BM					
BC847CM					

[1] For further information and the availability of packing methods, see [Section 13](#).

[2] Valid for all available selection groups.

10. Soldering

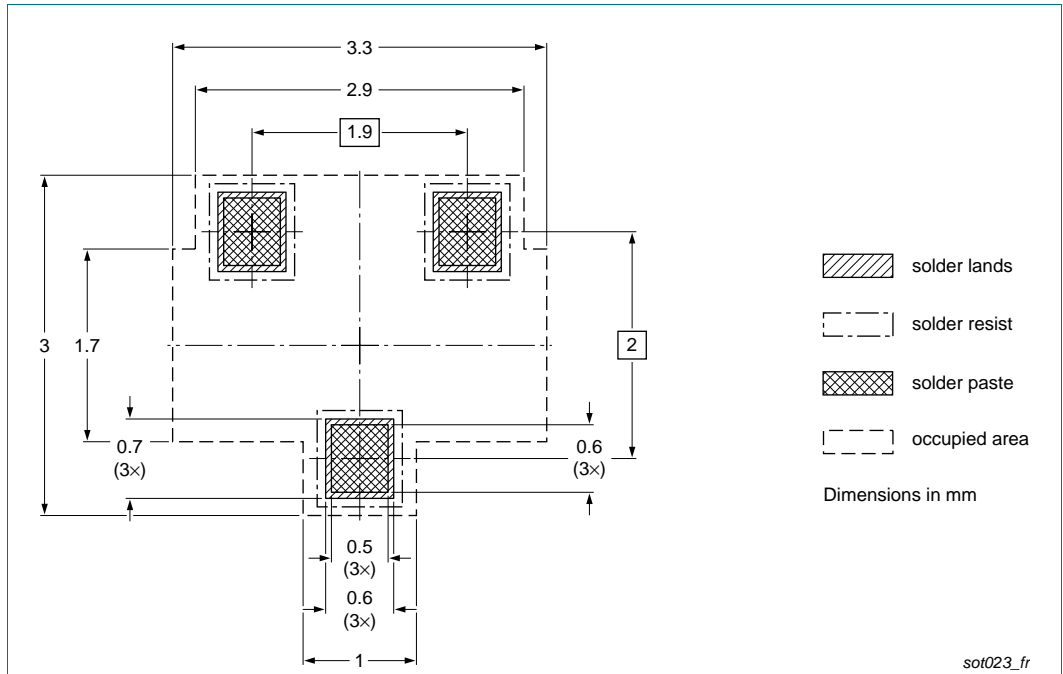

Fig 17. Reflow soldering footprint SOT23 (TO-236AB)

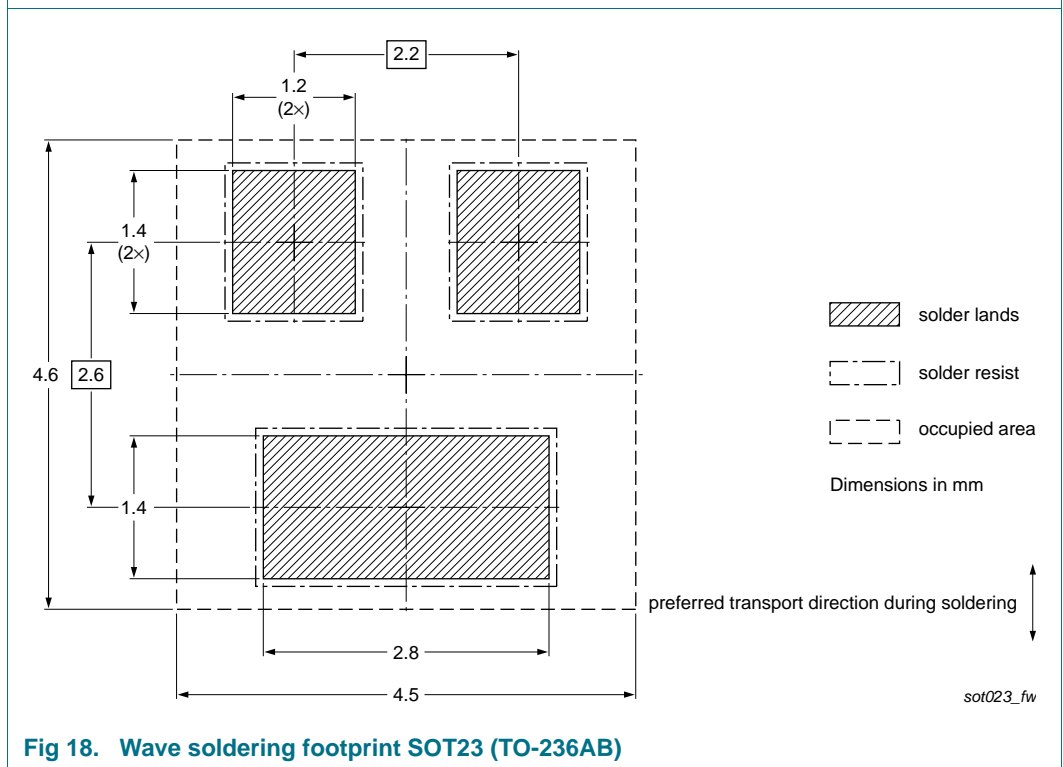

Fig 18. Wave soldering footprint SOT23 (TO-236AB)

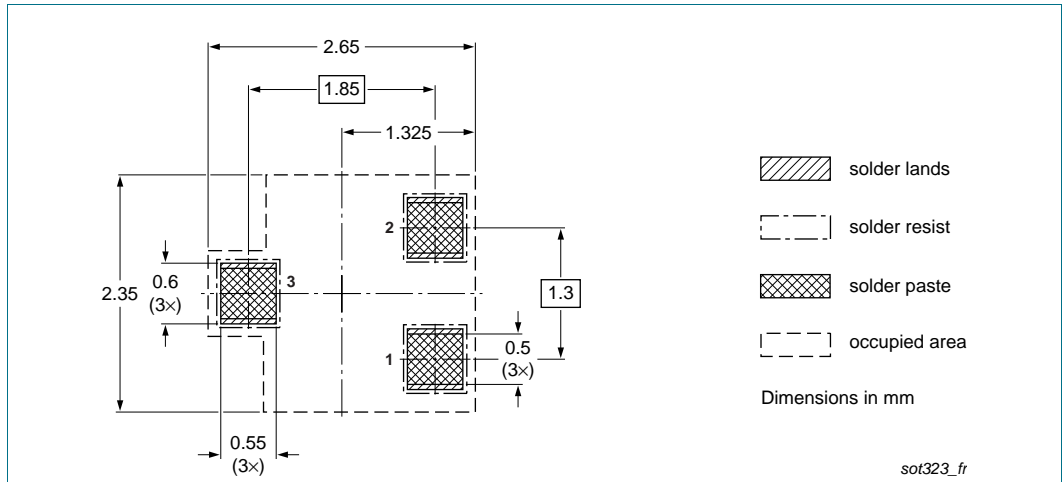

Fig 19. Reflow soldering footprint SOT323 (SC-70)

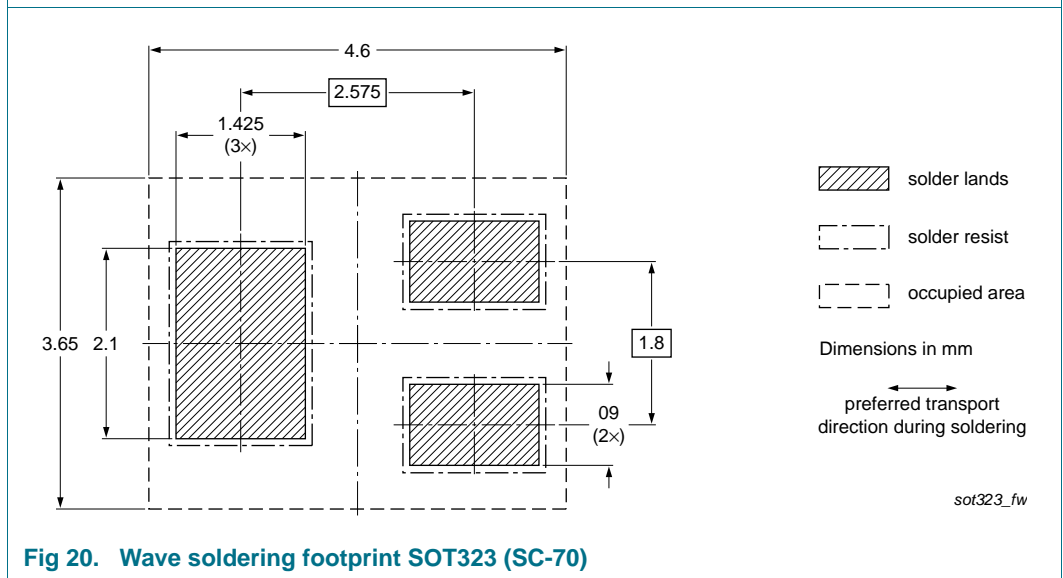

Fig 20. Wave soldering footprint SOT323 (SC-70)

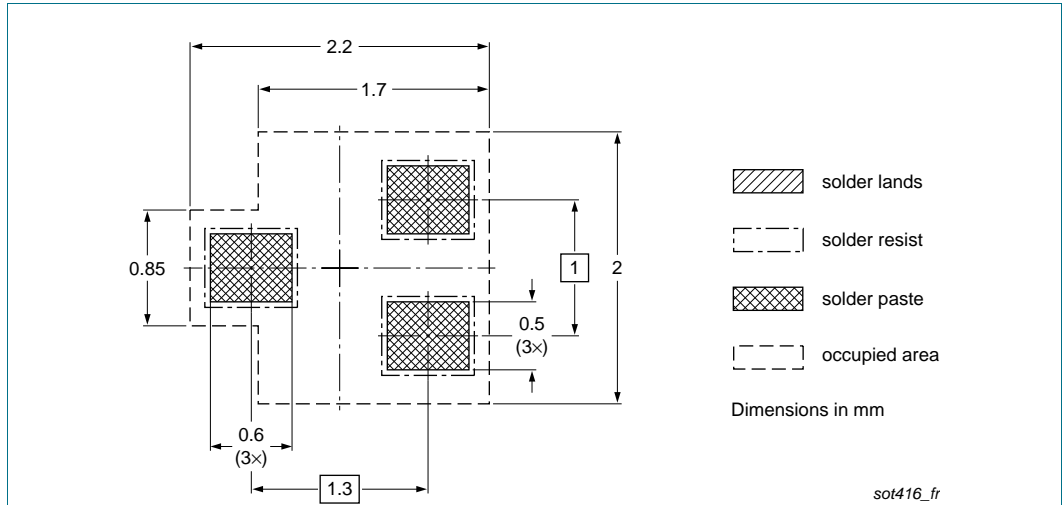

Fig 21. Reflow soldering footprint SOT416 (SC-75)

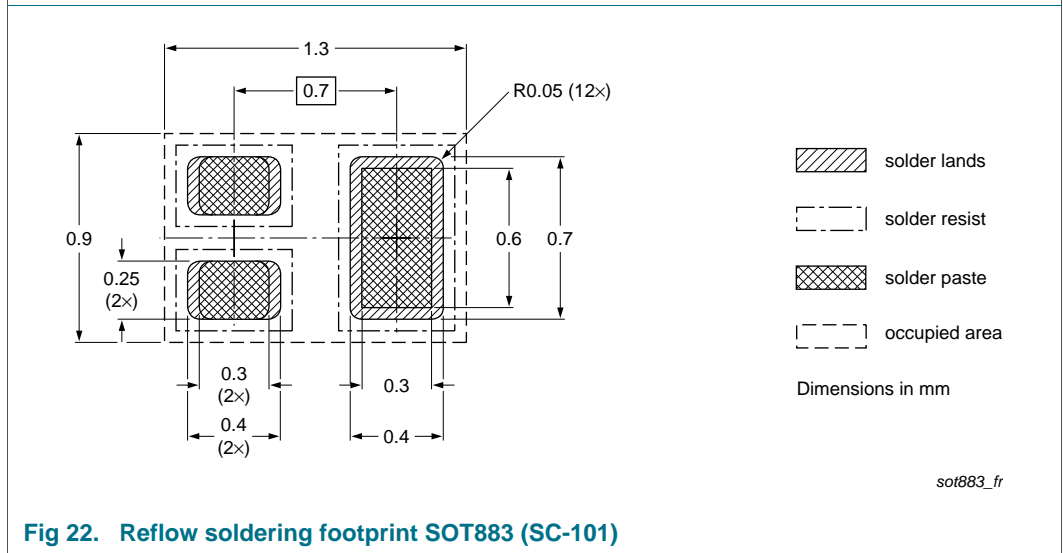

Fig 22. Reflow soldering footprint SOT883 (SC-101)

11. Revision history

Table 10. Revision history

Document ID	Release date	Data sheet status	Change notice	Supersedes
BC847_SER v.8	20120820	Product data sheet	-	BC847_BC547_SER v.7
Modifications:	<ul style="list-style-type: none">Type numbers removed: BC847B/DG, BC847BW/DG, BC847AT/DG, BC857, BC857B and BC857CSection 12 "Legal information": updated			
BC847_BC547_SER v.7	20081210	Product data sheet	-	BC847_BC547_SER v.6
BC847_BC547_SER v.6	20050519	Product data sheet	-	-

12. Legal information

12.1 Data sheet status

Document status ^{[1][2]}	Product status ^[3]	Definition
Objective [short] data sheet	Development	This document contains data from the objective specification for product development.
Preliminary [short] data sheet	Qualification	This document contains data from the preliminary specification.
Product [short] data sheet	Production	This document contains the product specification.

[1] Please consult the most recently issued document before initiating or completing a design.

[2] The term 'short data sheet' is explained in section "Definitions".

[3] The product status of device(s) described in this document may have changed since this document was published and may differ in case of multiple devices. The latest product status information is available on the Internet at URL <http://www.nxp.com>.

12.2 Definitions

Draft — The document is a draft version only. The content is still under internal review and subject to formal approval, which may result in modifications or additions. NXP Semiconductors does not give any representations or warranties as to the accuracy or completeness of information included herein and shall have no liability for the consequences of use of such information.

Short data sheet — A short data sheet is an extract from a full data sheet with the same product type number(s) and title. A short data sheet is intended for quick reference only and should not be relied upon to contain detailed and full information. For detailed and full information see the relevant full data sheet, which is available on request via the local NXP Semiconductors sales office. In case of any inconsistency or conflict with the short data sheet, the full data sheet shall prevail.

Product specification — The information and data provided in a Product data sheet shall define the specification of the product as agreed between NXP Semiconductors and its customer, unless NXP Semiconductors and customer have explicitly agreed otherwise in writing. In no event however, shall an agreement be valid in which the NXP Semiconductors product is deemed to offer functions and qualities beyond those described in the Product data sheet.

12.3 Disclaimers

Limited warranty and liability — Information in this document is believed to be accurate and reliable. However, NXP Semiconductors does not give any representations or warranties, expressed or implied, as to the accuracy or completeness of such information and shall have no liability for the consequences of use of such information. NXP Semiconductors takes no responsibility for the content in this document if provided by an information source outside of NXP Semiconductors.

In no event shall NXP Semiconductors be liable for any indirect, incidental, punitive, special or consequential damages (including - without limitation - lost profits, lost savings, business interruption, costs related to the removal or replacement of any products or rework charges) whether or not such damages are based on tort (including negligence), warranty, breach of contract or any other legal theory.

Notwithstanding any damages that customer might incur for any reason whatsoever, NXP Semiconductors' aggregate and cumulative liability towards customer for the products described herein shall be limited in accordance with the *Terms and conditions of commercial sale* of NXP Semiconductors.

Right to make changes — NXP Semiconductors reserves the right to make changes to information published in this document, including without limitation specifications and product descriptions, at any time and without notice. This document supersedes and replaces all information supplied prior to the publication hereof.

Suitability for use — NXP Semiconductors products are not designed, authorized or warranted to be suitable for use in life support, life-critical or safety-critical systems or equipment, nor in applications where failure or malfunction of an NXP Semiconductors product can reasonably be expected to result in personal injury, death or severe property or environmental damage. NXP Semiconductors and its suppliers accept no liability for inclusion and/or use of NXP Semiconductors products in such equipment or applications and therefore such inclusion and/or use is at the customer's own risk.

Applications — Applications that are described herein for any of these products are for illustrative purposes only. NXP Semiconductors makes no representation or warranty that such applications will be suitable for the specified use without further testing or modification.

Customers are responsible for the design and operation of their applications and products using NXP Semiconductors products, and NXP Semiconductors accepts no liability for any assistance with applications or customer product design. It is customer's sole responsibility to determine whether the NXP Semiconductors product is suitable and fit for the customer's applications and products planned, as well as for the planned application and use of customer's third party customer(s). Customers should provide appropriate design and operating safeguards to minimize the risks associated with their applications and products.

NXP Semiconductors does not accept any liability related to any default, damage, costs or problem which is based on any weakness or default in the customer's applications or products, or the application or use by customer's third party customer(s). Customer is responsible for doing all necessary testing for the customer's applications and products using NXP Semiconductors products in order to avoid a default of the applications and the products or of the application or use by customer's third party customer(s). NXP does not accept any liability in this respect.

Limiting values — Stress above one or more limiting values (as defined in the Absolute Maximum Ratings System of IEC 60134) will cause permanent damage to the device. Limiting values are stress ratings only and (proper) operation of the device at these or any other conditions above those given in the Recommended operating conditions section (if present) or the Characteristics sections of this document is not warranted. Constant or repeated exposure to limiting values will permanently and irreversibly affect the quality and reliability of the device.

Terms and conditions of commercial sale — NXP Semiconductors products are sold subject to the general terms and conditions of commercial sale, as published at <http://www.nxp.com/profile/terms>, unless otherwise agreed in a valid written individual agreement. In case an individual agreement is concluded only the terms and conditions of the respective agreement shall apply. NXP Semiconductors hereby expressly objects to applying the customer's general terms and conditions with regard to the purchase of NXP Semiconductors products by customer.

No offer to sell or license — Nothing in this document may be interpreted or construed as an offer to sell products that is open for acceptance or the grant, conveyance or implication of any license under any copyrights, patents or other industrial or intellectual property rights.

Export control — This document as well as the item(s) described herein may be subject to export control regulations. Export might require a prior authorization from competent authorities.

Quick reference data — The Quick reference data is an extract of the product data given in the Limiting values and Characteristics sections of this document, and as such is not complete, exhaustive or legally binding.

Non-automotive qualified products — Unless this data sheet expressly states that this specific NXP Semiconductors product is automotive qualified, the product is not suitable for automotive use. It is neither qualified nor tested in accordance with automotive testing or application requirements. NXP Semiconductors accepts no liability for inclusion and/or use of non-automotive qualified products in automotive equipment or applications.

In the event that customer uses the product for design-in and use in automotive applications to automotive specifications and standards, customer (a) shall use the product without NXP Semiconductors' warranty of the product for such automotive applications, use and specifications, and (b) whenever customer uses the product for automotive applications beyond NXP Semiconductors' specifications such use shall be solely at customer's own risk, and (c) customer fully indemnifies NXP Semiconductors for any liability, damages or failed product claims resulting from customer design and use of the product for automotive applications beyond NXP Semiconductors' standard warranty and NXP Semiconductors' product specifications.

12.4 Trademarks

Notice: All referenced brands, product names, service names and trademarks are the property of their respective owners.

13. Contact information

For more information, please visit: <http://www.nxp.com>

For sales office addresses, please send an email to: salesaddresses@nxp.com

14. Contents

1	Product profile	1
1.1	General description	1
1.2	Features and benefits	1
1.3	Applications	1
1.4	Quick reference data	2
2	Pinning information	2
3	Ordering information	3
4	Marking	3
5	Limiting values	4
6	Thermal characteristics	4
7	Characteristics	5
8	Package outline	9
9	Packing information	11
10	Soldering	12
11	Revision history	15
12	Legal information	16
12.1	Data sheet status	16
12.2	Definitions	16
12.3	Disclaimers	16
12.4	Trademarks	17
13	Contact information	17
14	Contents	18

Please be aware that important notices concerning this document and the product(s) described herein, have been included in section 'Legal information'.

© NXP B.V. 2012.

All rights reserved.

For more information, please visit: <http://www.nxp.com>

For sales office addresses, please send an email to: salesaddresses@nxp.com

Date of release: 20 August 2012

Document identifier: BC847_SER