

## SOT-23 Plastic-Encapsulate Transistors

TRANSISTOR( NPN )

### Features

- Ideally suited for automatic insertion
- For Switching and AF Amplifier Applications

### Marking:

- BC846A=1A;BC846B=1B;
- BC847A=1E;BC847B=1F;BC847C=1G;
- BC848A=1J;BC848B=1K;BC848C=1L;

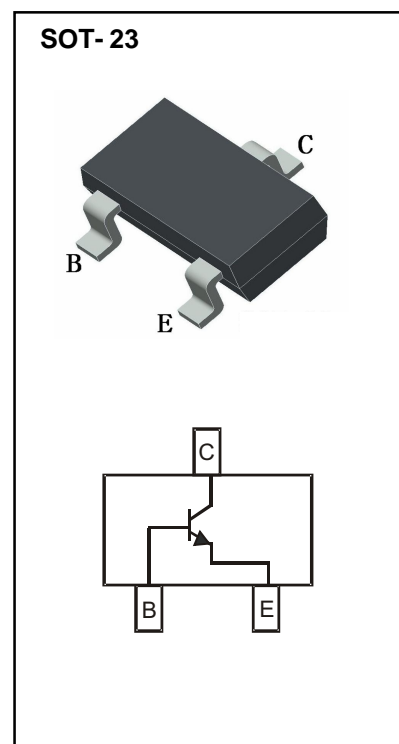

### Limiting Values (Absolute Maximum Rating)

Item	Symbol	Unit	Conditions	Value
Collector-Base Voltage	BC846 BC847 BC848	VCBO	V	80 50 30
Collector-Emitter Voltage	BC846 BC847 BC848	VCEO	V	65 45 30
Emitter-Base Voltage		VEBO	V	6
Collector Current		IC	A	-0.1
Total Device Dissipation		PC	W	0.2
Thermal Resistance From Junction To Ambient		R <sub>θJA</sub>	°C/W	625
Junction Temperature		T <sub>j</sub>	°C	150
Storage Temperature		TSTG	°C	-55 to +150

## Electrical Characteristics ( $T_A=25^\circ\text{C}$ unless otherwise noted)

Parameter	Symbol	Test conditions	Min	Typ	Max	Unit	
Collector-base breakdown voltage	BC846	$I_C=10\mu\text{A}, I_E=0$	80			V	
	BC847		50				
	BC848		30				
Collector-emitter breakdown voltage	BC846	$I_C=10\text{mA}, I_B=0$	65			V	
	BC847		45				
	BC848		30				
Emitter-base breakdown voltage	$V_{EBO}$	$I_E=10\mu\text{A}, I_C=0$	6			V	
Collector cut-off current	BC846	$I_{CBO}$	$V_{CB}=70\text{V}, I_E=0$			0.1	$\mu\text{A}$
	BC847		$V_{CB}=50\text{V}, I_E=0$				
	BC848		$V_{CB}=30\text{V}, I_E=0$				
Collector cut-off current	BC846	$I_{CEO}$	$V_{CE}=60\text{V}, I_B=0$			0.1	$\mu\text{A}$
	BC847		$V_{CE}=45\text{V}, I_B=0$				
	BC848		$V_{CE}=30\text{V}, I_B=0$				
Emitter cut-off current	$I_{EBO}$	$V_{EB}=5\text{V}, I_C=0$			0.1	$\mu\text{A}$	
DC current gain	BC846A,847A,848A	$h_{FE}$	$V_{CE}=5\text{V}, I_C=2\text{mA}$	110		220	
	BC846B,847B,848B			200		450	
	BC847C,BC848C			420		800	
Collector-emitter saturation voltage	$V_{CE(sat)}$	$I_C=100\text{mA}, I_B=5\text{mA}$			0.5	V	
Base-emitter saturation voltage	$V_{BE(sat)}$	$I_C=100\text{mA}, I_B=5\text{mA}$			1.1	V	
Transition frequency	$f_T$	$V_{CE}=5\text{V}, I_C=10\text{mA}$ $f=100\text{MHz}$	100			MHz	
Collector output capacitance	$C_{ob}$	$V_{CB}=10\text{V}, f=1\text{MHz}$			4.5	pF	

# Typical Characteristics

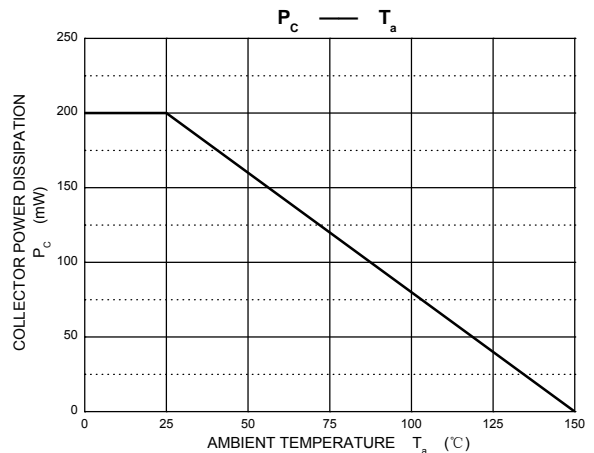
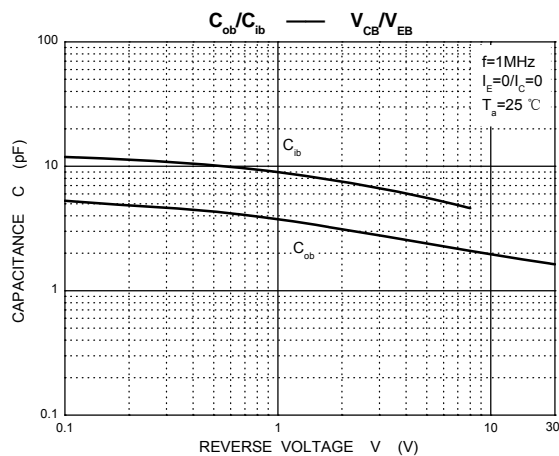
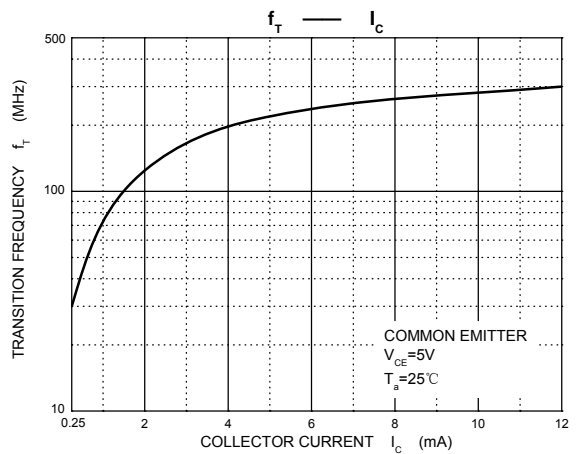
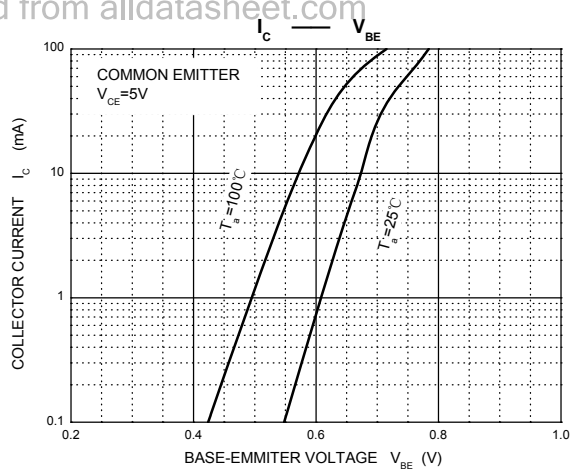
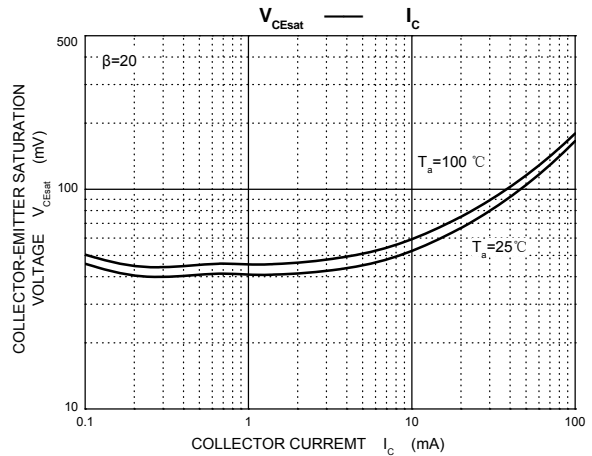
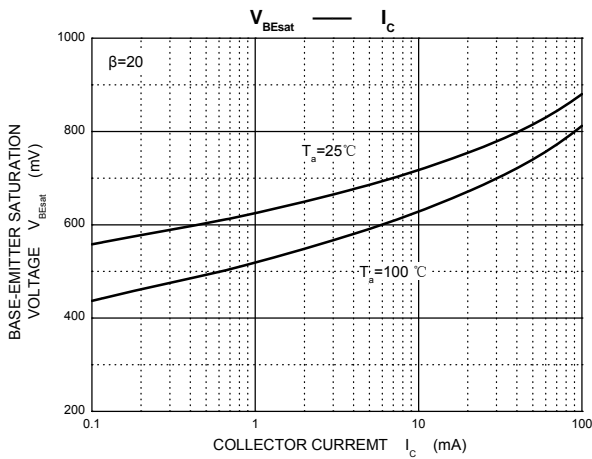
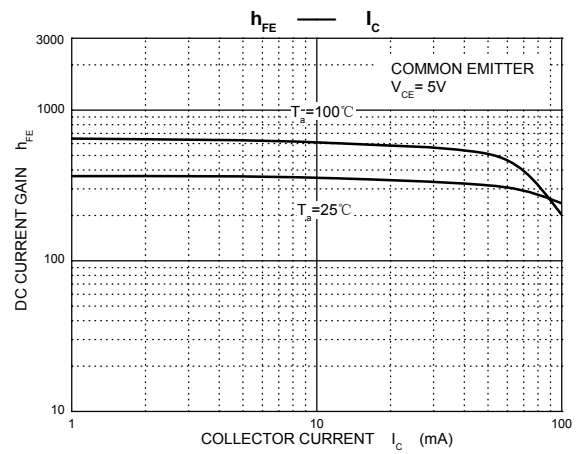
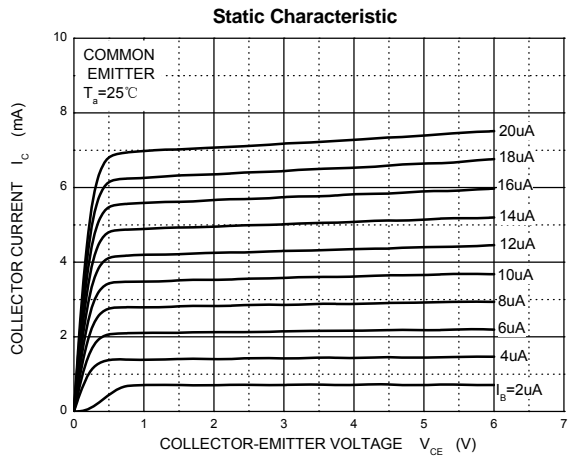

## SOT-23 Package Outline Dimensions

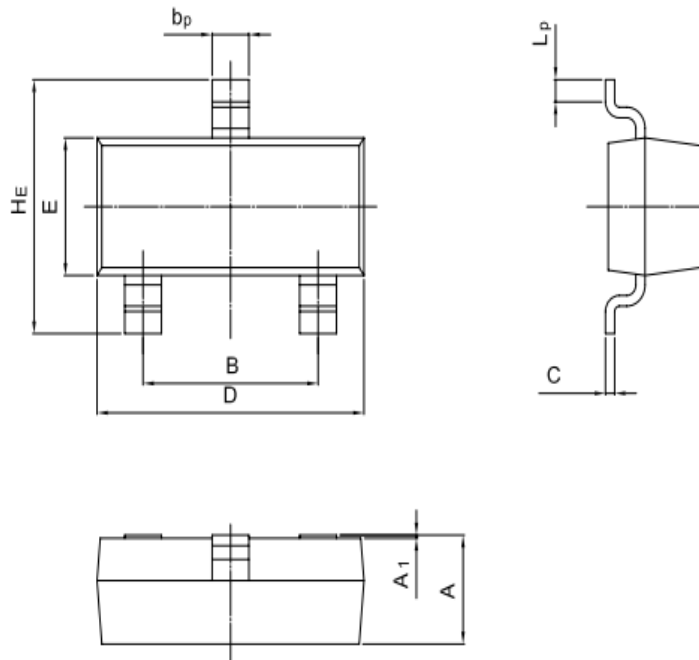

UNIT	A	B	bp	C	D	E	HE	A1	Lp
mm	1.40 0.95	2.04 1.78	0.50 0.35	0.19 0.08	3.10 2.70	1.65 1.20	3.00 2.20	0.100 0.013	0.50 0.20

Downloaded from alldatasheet.com

## SOT-23 Suggested Pad Layout

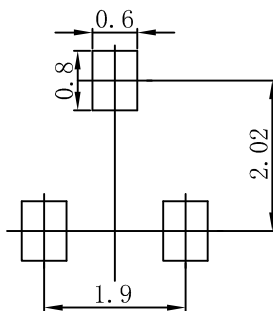

**Note:**

1. Controlling dimension: in millimeters.
2. General tolerance:  $\pm 0.05\text{mm}$ .
3. The pad layout is for reference purposes only.

**NOTICE**

JSJD reserve the right to make modifications, enhancements, improvements, corrections or other changes without further notice to any product herein. JSJD does not assume any liability arising out of the application or use of any product described herein.

# Reel Taping Specifications For Surface Mount Devices-SOT-23

## SOT-23 Embossed Carrier Tape

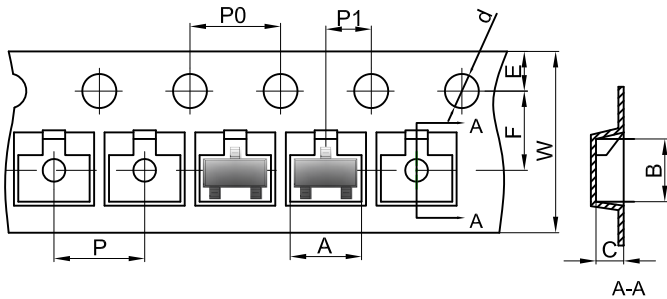

### Packaging Description:

SOT-23 parts are shipped in tape. The carrier tape is made from a dissipative (carbon filled) polycarbonate resin. The cover tape is a multilayer film (Heat Activated Adhesive in nature) primarily composed of polyester film, adhesive layer, sealant, and anti-static sprayed agent. These reeled parts in standard option are shipped with 3,000 units per 7" or 17.8cm diameter reel. The reels are clear in color and is made of polystyrene plastic (anti-static coated).

Dimensions are in millimeter										
Pkg type	A	B	C	d	E	F	P0	P	P1	W
SOT-23	3.15	2.77	1.22	Ø1.50	1.75	3.50	4.00	4.00	2.00	8.00

## SOT-23 Tape Leader and Trailer

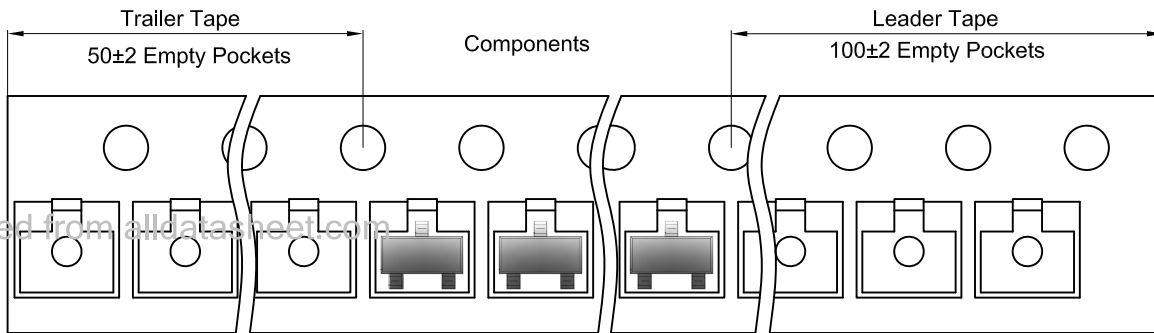

## SOT-23 Reel

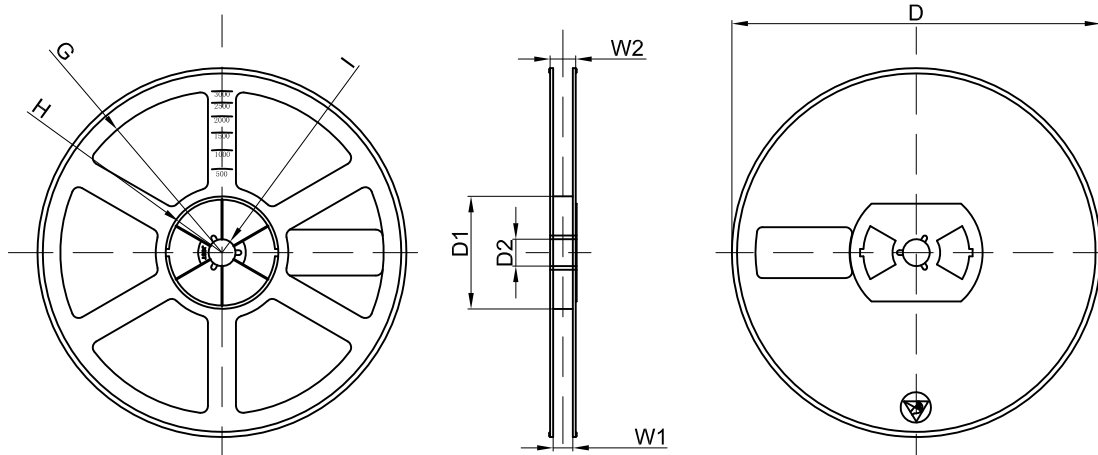

Dimensions are in millimeter								
Reel Option	D	D1	D2	G	H	I	W1	W2
7"Dia	Ø178.00	54.40	13.00	R78.00	R25.60	R6.50	9.50	12.30

REEL	Reel Size	Box	Box Size(mm)	Carton	Carton Size(mm)	G.W.(kg)
3000 pcs	7 inch	45,000 pcs	203×203×195	180,000 pcs	438×438×230	