

## PNP Silicon AF Transistors

## BC 856W ... BC 860W

### Features

- For AF input stages and driver applications
- High current gain
- Low collector-emitter saturation voltage
- Low noise between 30 Hz and 15 kHz
- Complementary types: BC 847W, BC 848W,  
BC 849W, BC 850W (NPN)

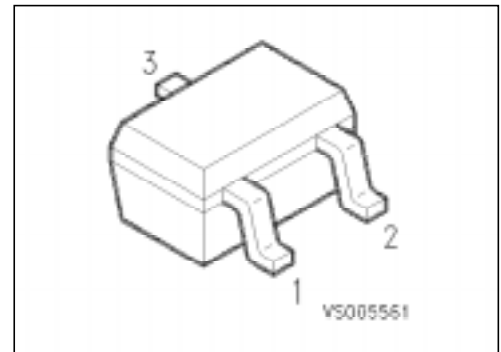

Type	Marking	Ordering Code (tape and reel)	Pin Configuration			Package <sup>1)</sup>
			1	2	3	
BC 856 AW	3As	Q62702-C2335	B	E	C	SOT-323
BC 856 BW	3Bs	Q62702-C2292				
BC 857 AW	3Es	Q62702-C2293				
BC 857 BW	3Fs	Q62702-C2294				
BC 857 CW	3Gs	Q62702-C2295				
BC 858 AW	3Js	Q62702-C2296				
BC 858 BW	3Ks	Q62702-C2297				
BC 858 CW	3Ls	Q62702-C2298				
BC 859 AW	4As	Q62702-C2299				
BC 859 BW	4Bs	Q62702-C2300				
BC 859 CW	4Cs	Q62702-C2301				
BC 860 BW	4Fs	Q62702-C2302				
BC 860 CW	4Gs	Q62702-C2303				

<sup>1)</sup>For detailed information see chapter Package Outlines.

## Maximum Ratings

Description	Symbol	BC 856W	BC 857W BC 860W	BC 858W BC 859W	Unit
		Collector-emitter voltage	$V_{CEO}$	65	
Collector-base voltage	$V_{CBO}$	80	50	30	V
Collector-emitter voltage	$V_{CES}$	80	50	30	V
Emitter-base voltage	$V_{EBO}$	5	5	5	V
Collector current	$I_C$	100			mA
Collector peak current	$I_{CM}$	200			mA
Total power dissipation, $T_s = 115\text{ °C}$	$P_{tot}$	250			mW
Junction temperature	$T_j$	150			°C
Storage temperature range	$T_{stg}$	-65 to 150			°C

## Thermal Resistance

Junction - ambient <sup>1)</sup>	$R_{th JA}$	≤ 240	K/W
Junction - soldering point	$R_{th JS}$	≤ 105	K/W

## Electrical Characteristics

at  $T_A = 25\text{ °C}$ , unless otherwise specified.

Parameter	Symbol	Values			Unit
		min.	typ.	max.	

### DC characteristics

Collector-emitter breakdown voltage $I_C = 10\text{ mA}$ BC 856W BC 857W, BC 860W BC 858W, BC 859W	$V_{(BR)CE0}$	65 45 30	— — —	— — —	V
Collector-base breakdown voltage $I_C = 10\text{ }\mu\text{A}$ BC 856W BC 857W, BC 860W BC 858W, BC 859W	$V_{(BR)CB0}$	80 50 30	— — —	— — —	
Collector-emitter breakdown voltage $I_C = 10\text{ }\mu\text{A}$ , $V_{BE} = 0$ BC 856W BC 857W, BC 860W BC 858W, BC 859W	$V_{(BR)CES}$	80 50 30	— — —	— — —	
Emitter-base breakdown voltage $I_E = 1\text{ }\mu\text{A}$	$V_{(BR)EB0}$	5	—	—	
Collector cutoff current $V_{CB} = 30\text{ V}$ $V_{CB} = 30\text{ V}$ , $T_A = 150\text{ °C}$	$I_{CB0}$	— —	— —	15 5	nA $\mu\text{A}$
DC current gain $I_C = 10\text{ }\mu\text{A}$ , $V_{CE} = 5\text{ V}$ BC 856 AW ... BC 859 AW BC 856 BW ... BC 860 BW BC 857 CW ... BC 860 CW $I_C = 2\text{ mA}$ , $V_{CE} = 5\text{ V}$ BC 856 AW ... BC 859 AW BC 856 BW ... BC 860 BW BC 857 CW ... BC 860 CW	$h_{FE}$	— — — 125 220 420	140 250 480 180 290 520	— — — 250 475 800	—
Collector-emitter saturation voltage <sup>1)</sup> $I_C = 10\text{ mA}$ , $I_B = 0.5\text{ mA}$ $I_C = 100\text{ mA}$ , $I_B = 5\text{ mA}$	$V_{CEsat}$	— —	75 250	300 650	mV
Base-emitter saturation voltage <sup>1)</sup> $I_C = 10\text{ mA}$ , $I_B = 0.5\text{ mA}$ $I_C = 100\text{ mA}$ , $I_B = 5\text{ mA}$	$V_{BEsat}$	— —	700 850	— —	
Base-emitter voltage $I_C = 2\text{ mA}$ , $V_{CE} = 5\text{ V}$ $I_C = 10\text{ mA}$ , $V_{CE} = 5\text{ V}$	$V_{BE(on)}$	600 —	650 —	750 820	

<sup>1)</sup>Pulse test:  $t \leq 300\text{ }\mu\text{s}$ ,  $D = 2\text{ %}$ .

## Electrical Characteristics

at  $T_A = 25^\circ\text{C}$ , unless otherwise specified.

Parameter	Symbol	Values			Unit
		min.	typ.	max.	
<b>AC characteristics</b>					
Transition frequency $I_C = 20\text{ mA}$ , $V_{CE} = 5\text{ V}$ , $f = 100\text{ MHz}$	$f_T$	–	250	–	MHz
Output capacitance $V_{CB} = 10\text{ V}$ , $f = 1\text{ MHz}$	$C_{obo}$	–	3	–	pF
Input capacitance $V_{CB} = 0.5\text{ V}$ , $f = 1\text{ MHz}$	$C_{ibo}$	–	10	–	
Short-circuit input impedance $I_C = 2\text{ mA}$ , $V_{CE} = 5\text{ V}$ , $f = 1\text{ kHz}$ BC 856 AW ... BC 859 AW BC 856 BW ... BC 860 BW BC 857 CW ... BC 860 CW	$h_{11e}$	–	2.7 4.5 8.7	–	k $\Omega$
Open-circuit reverse voltage transfer ratio $I_C = 2\text{ mA}$ , $V_{CE} = 5\text{ V}$ , $f = 1\text{ kHz}$ BC 856 AW ... BC 859 AW BC 856 BW ... BC 860 BW BC 857 CW ... BC 860 CW	$h_{12e}$	–	1.5 2.0 3.0	–	$10^{-4}$
Short-circuit forward current transfer ratio $I_C = 2\text{ mA}$ , $V_{CE} = 5\text{ V}$ , $f = 1\text{ kHz}$ BC 856 AW ... BC 859 AW BC 856 BW ... BC 860 BW BC 857 CW ... BC 860 CW	$h_{21e}$	–	200 330 600	–	–
Open-circuit output admittance $I_C = 2\text{ mA}$ , $V_{CE} = 5\text{ V}$ , $f = 1\text{ kHz}$ BC 856 AW ... BC 859 AW BC 856 BW ... BC 860 BW BC 857 CW ... BC 860 CW	$h_{22e}$	–	18 30 60	–	$\mu\text{S}$
Noise figure $I_C = 0.2\text{ mA}$ , $V_{CE} = 5\text{ V}$ , $R_S = 2\text{ k}\Omega$ $f = 30\text{ Hz} \dots 15\text{ kHz}$ BC 859W BC 860W $f = 1\text{ kHz}$ , $\Delta f = 200\text{ Hz}$ BC 859W BC 860W	$F$	–	1.2 1.0 1.0 1.0	4 3 4 4	dB
Equivalent noise voltage $I_C = 0.2\text{ mA}$ , $V_{CE} = 5\text{ V}$ , $R_S = 2\text{ k}\Omega$ $f = 10\text{ Hz} \dots 50\text{ Hz}$ BC 860W	$V_n$	–	–	0.110	$\mu\text{V}$

**Total power dissipation  $P_{tot} = f(T_A^*; T_S)$**

\* Package mounted on epoxy

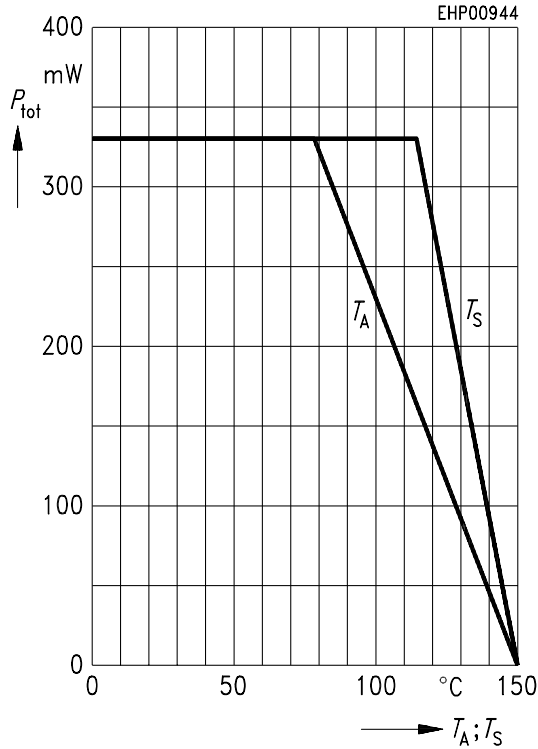

**Collector-base capacitance  $C_{CB0} = f(V_{CB0})$**

**Emitter-base capacitance  $C_{EB0} = f(V_{EB0})$**

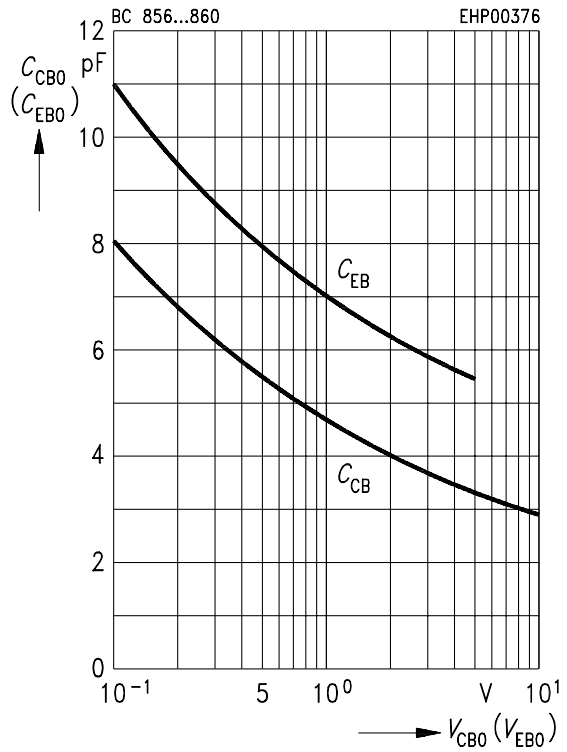

**Permissible pulse load  $P_{tot max}/P_{tot DC} = f(t_p)$**

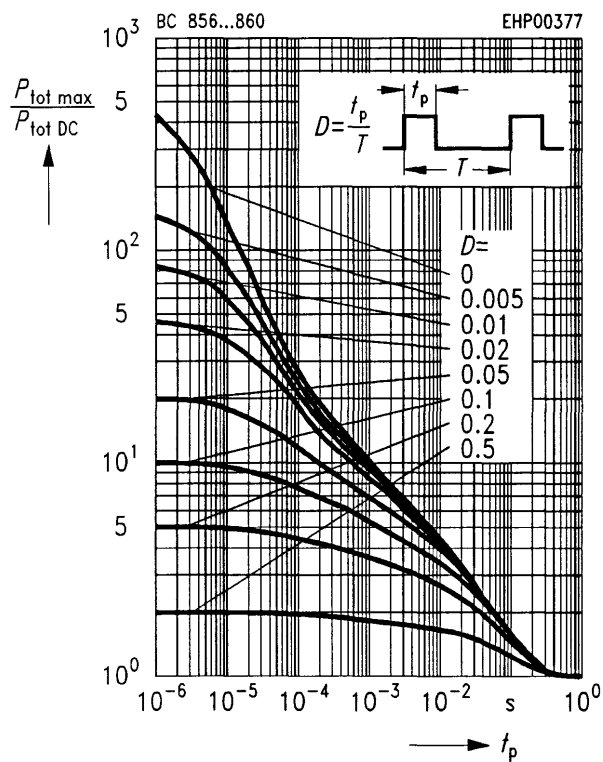

**Transition frequency  $f_T = f(I_C)$**

$V_{CE} = 5 V$

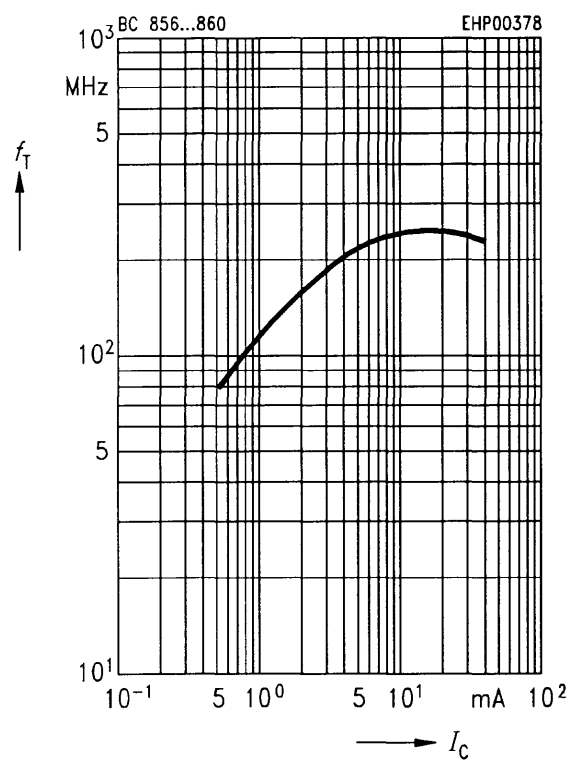

**Collector cutoff current  $I_{CB0} = f(T_A)$**

$V_{CB} = 30\text{ V}$

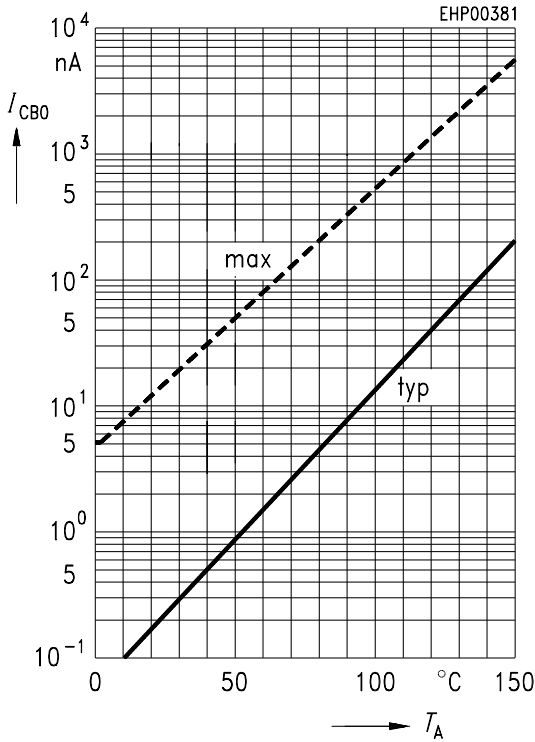

**Collector-emitter saturation voltage**

$I_C = f(V_{CEsat}), h_{FE} = 20$

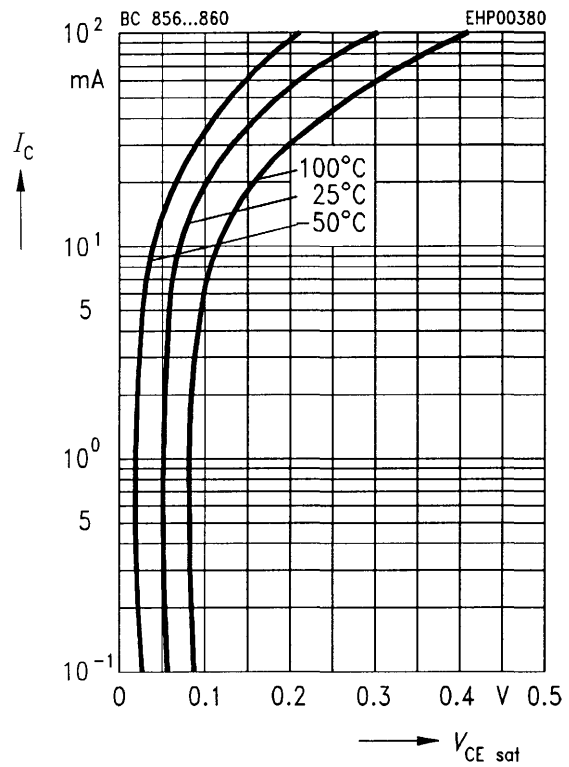

**DC current gain  $h_{FE} = f(I_C)$**

$V_{CE} = 5\text{ V}$

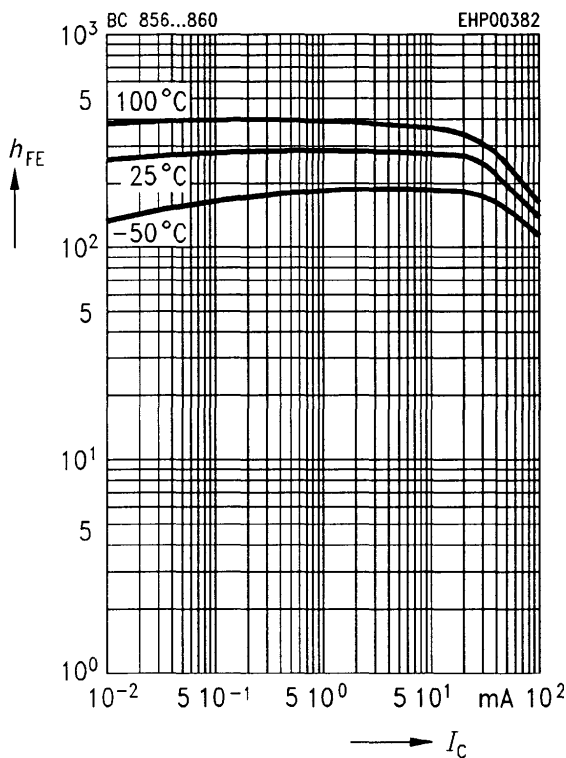

**Base-emitter saturation voltage**

$I_C = f(V_{BEsat}), h_{FE} = 20$

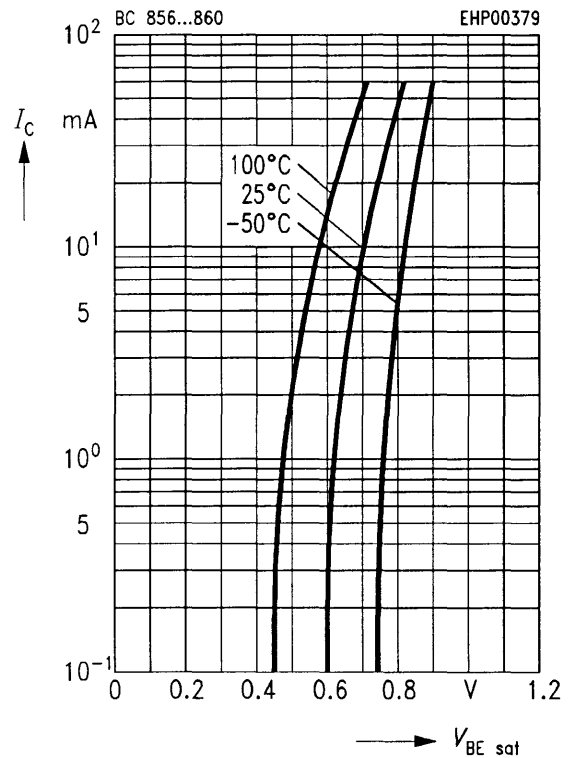

**h parameter  $h_e = f(I_C)$  normalized**

$V_{CE} = 5\text{ V}$

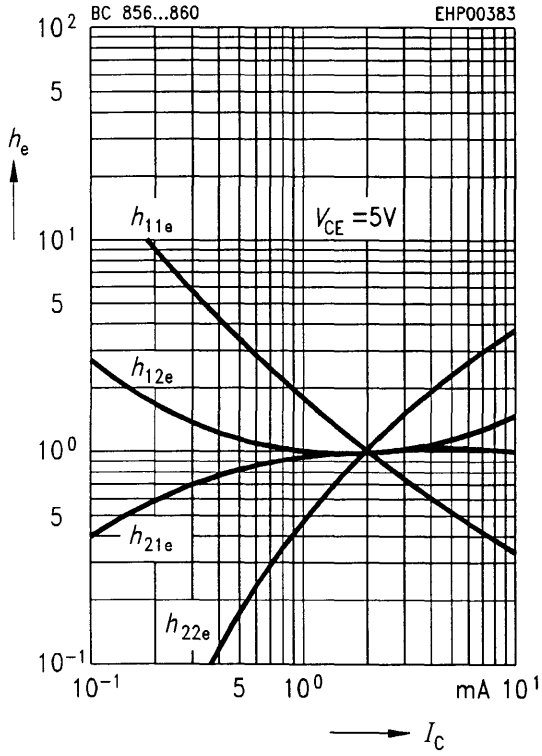

**h parameter  $h_e = f(V_{CE})$  normalized**

$I_C = 2\text{ mA}$

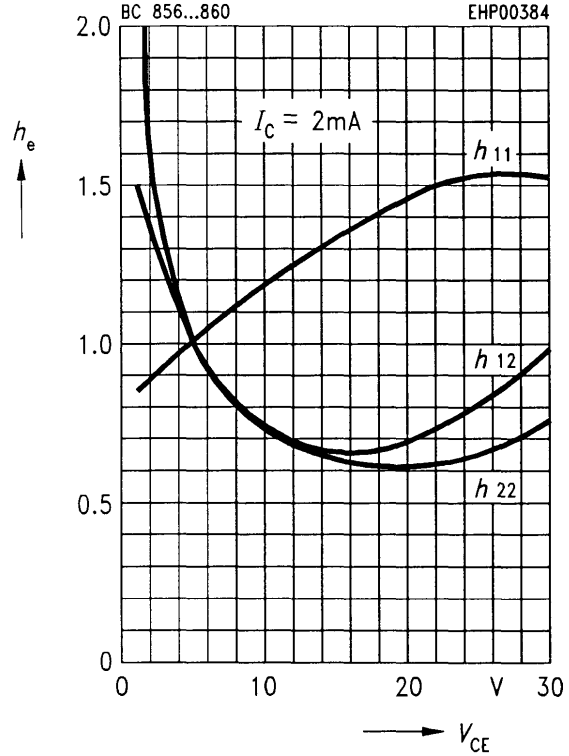

**Noise figure  $F = f(V_{CE})$**

$I_C = 0.2\text{ mA}$ ,  $R_S = 2\text{ k}\Omega$ ,  $f = 1\text{ kHz}$

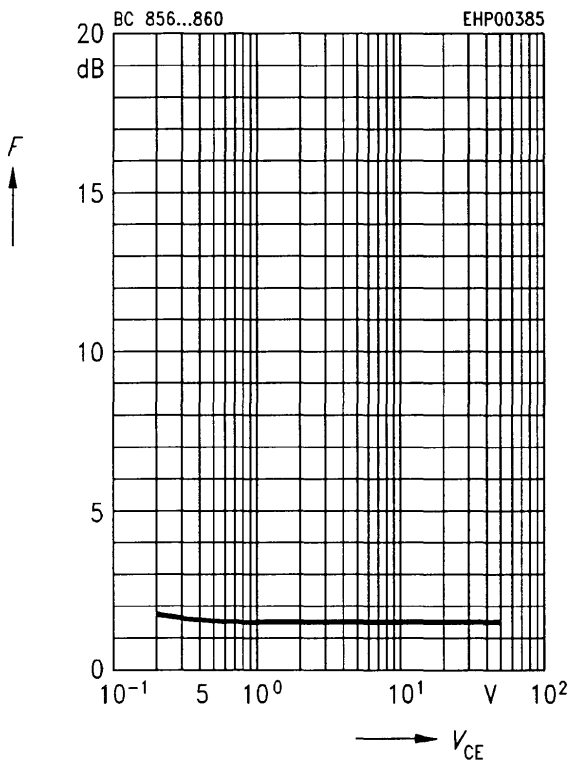

**Noise figure  $F = f(f)$**

$I_C = 0.2\text{ mA}$ ,  $V_{CE} = 5\text{ V}$ ,  $R_S = 2\text{ k}\Omega$

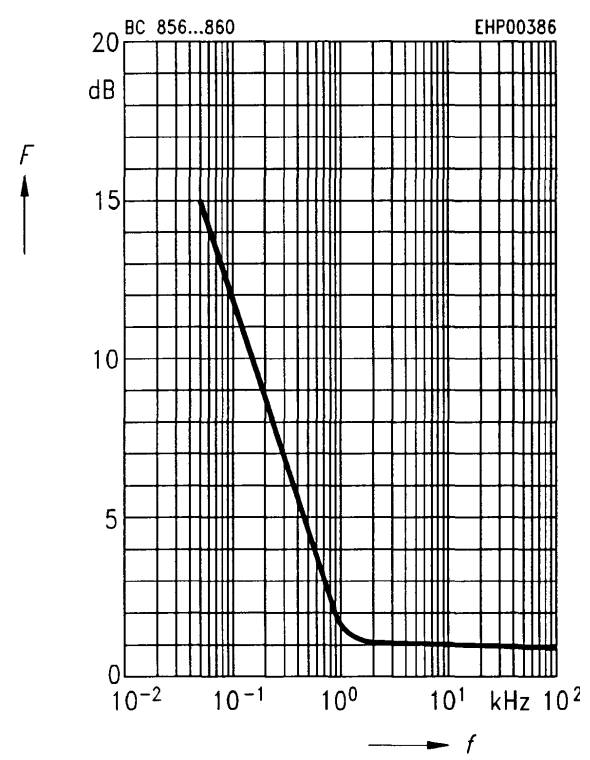

**Noise figure  $F = f(I_C)$**

$V_{CE} = 5\text{ V}, f = 120\text{ Hz}$

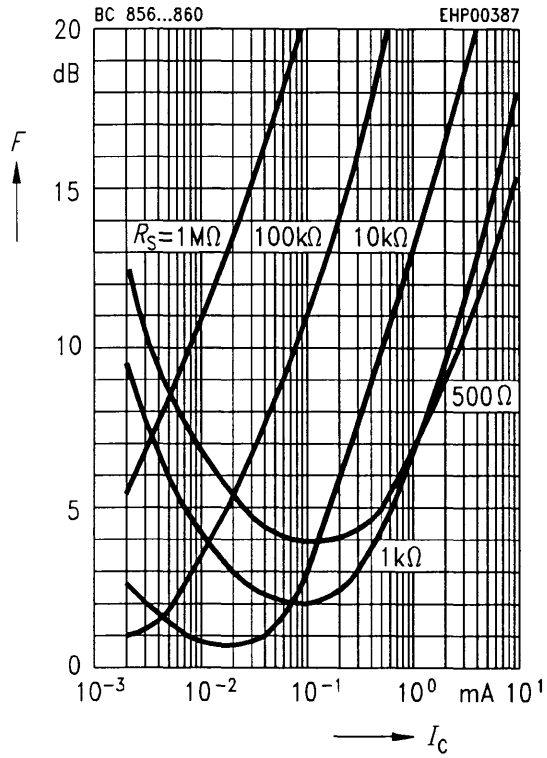

**Noise figure  $F = f(I_C)$**

$V_{CE} = 5\text{ V}, f = 1\text{ kHz}$

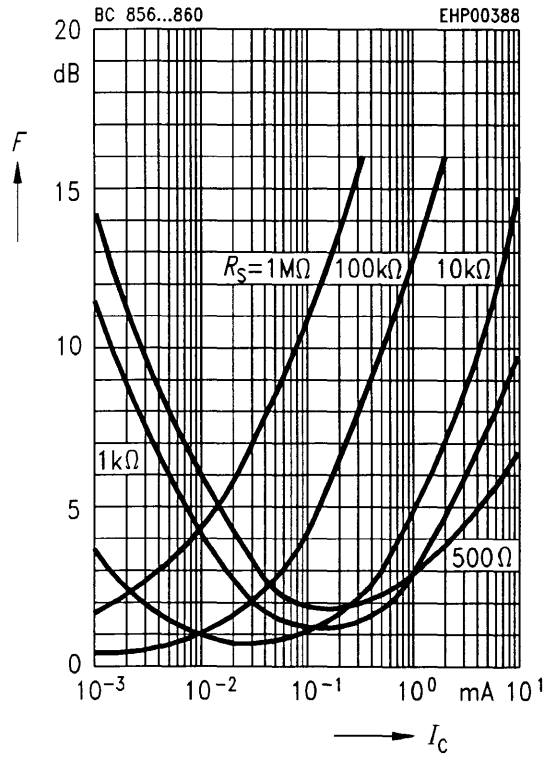

**Noise figure  $F = f(I_C)$**

$V_{CE} = 5\text{ V}, f = 10\text{ kHz}$

