

BCR16CM

MEDIUM POWER USE
NON-INSULATED TYPE, PLANAR PASSIVATION TYPE

BCR16CM

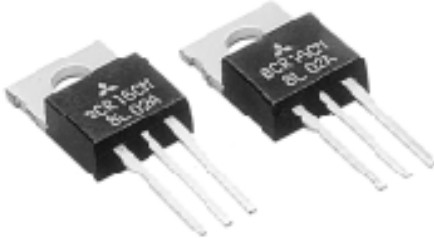

- **IT (RMS)** **16A**
- **VDRM** **400V/600V**
- **IFGT I , IRGT I , IRGT III** **30mA (20mA) *5**

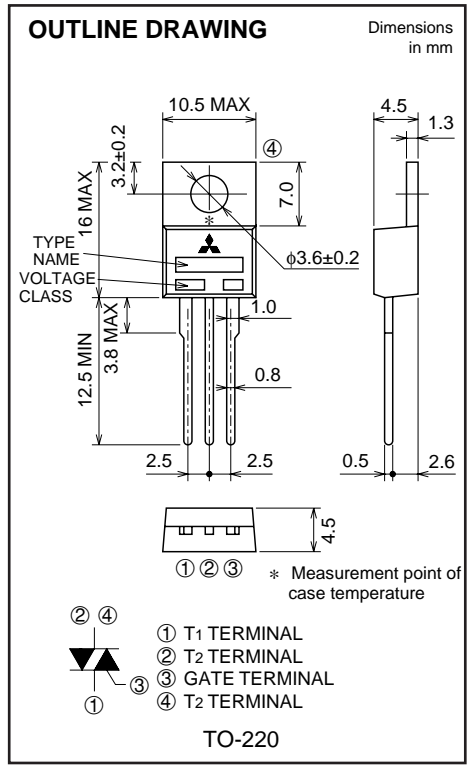

APPLICATION

Contactless AC switches , light dimmer, electric flasher unit, hair drier, control of household equipment such as TV sets · stereo · refrigerator · washing machine · infrared kotatsu · carpet · electric fan, solenoid drivers, small motor control, copying machine, electric tool, other general purpose control applications

MAXIMUM RATINGS

Symbol	Parameter	Voltage class		Unit
		8	12	
VDRM	Repetitive peak off-state voltage *1	400	600	V
VDSM	Non-repetitive peak off-state voltage *1	500	720	V

Symbol	Parameter	Conditions	Ratings	Unit
IT (RMS)	RMS on-state current	Commercial frequency, sine full wave 360° conduction, Tc=100°C	16	A
ITSM	Surge on-state current	60Hz sinewave 1 full cycle, peak value, non-repetitive	170	A
I ² t	I ² t for fusing	Value corresponding to 1 cycle of half wave 60Hz, surge on-state current	121	A ² s
PGM	Peak gate power dissipation		5.0	W
PG (AV)	Average gate power dissipation		0.5	W
VGM	Peak gate voltage		10	V
IGM	Peak gate current		2	A
Tj	Junction temperature		-40 ~ +125	°C
Tstg	Storage temperature		-40 ~ +125	°C
—	Weight	Typical value	2.0	g

*1. Gate open.

BCR16CM

MEDIUM POWER USE

NON-INSULATED TYPE, PLANAR PASSIVATION TYPE

ELECTRICAL CHARACTERISTICS

Symbol	Parameter	Test conditions	Limits			Unit	
			Min.	Typ.	Max.		
IDRM	Repetitive peak off-state current	T _j =125°C, V _{DRM} applied	—	—	2.0	mA	
V _{TM}	On-state voltage	T _c =25°C, I _{TM} =25A, Instantaneous measurement	—	—	1.5	V	
V _{FGT I}	Gate trigger voltage *2	T _j =25°C, V _D =6V, R _L =6Ω, R _G =330Ω	I	—	—	1.5	V
V _{RGT I}			II	—	—	1.5	V
V _{RGT III}			III	—	—	1.5	V
I _{FGT I}	Gate trigger current *2	T _j =25°C, V _D =6V, R _L =6Ω, R _G =330Ω	I	—	—	30*5	mA
I _{RGT I}			II	—	—	30*5	mA
I _{RGT III}			III	—	—	30*5	mA
V _{GD}	Gate non-trigger voltage	T _j =125°C, V _D =1/2V _{DRM}	0.2	—	—	V	
R _{th(j-c)}	Thermal resistance	Junction to case *4	—	—	1.4	°C/W	
(dv/dt) _c	Critical-rate of rise of off-state commutating voltage		*3	—	—	V/μs	

- *2. Measurement using the gate trigger characteristics measurement circuit.
- *3. The critical-rate of rise of the off-state commutating voltage is shown in the table below.
- *4. The contact thermal resistance R_{th(c-f)} in case of greasing is 1.0°C/W.
- *5. High sensitivity (I_{GT}≤20mA) is also available. (IGT item ①)

Voltage class	V _{DRM} (V)	(dv/dt) _c			Test conditions	Commutating voltage and current waveforms (inductive load)
		Symbol	Min.	Unit		
8	400	R	—	V/μs	1. Junction temperature T _j =125°C 2. Rate of decay of on-state commutating current (di/dt) _c =-8A/ms 3. Peak off-state voltage V _D =400V	
		L	10			
12	600	R	—			
		L	10			

PERFORMANCE CURVES

MAXIMUM ON-STATE CHARACTERISTICS

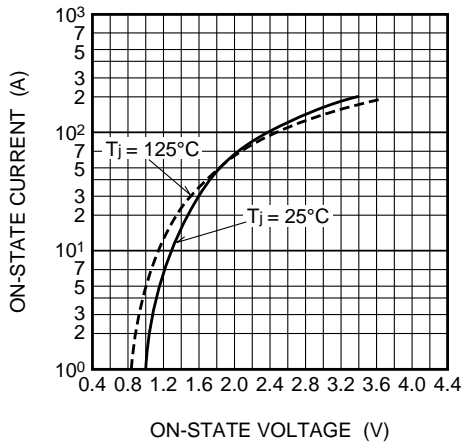

RATED SURGE ON-STATE CURRENT

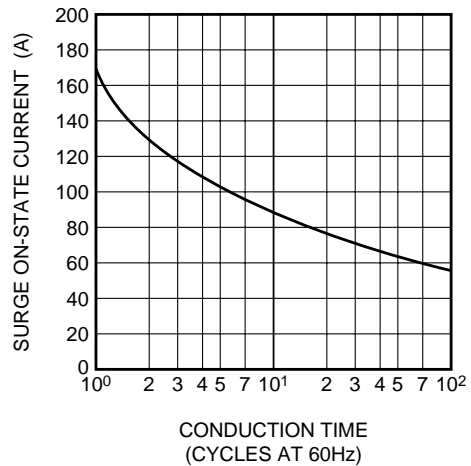

BCR16CM

MEDIUM POWER USE
NON-INSULATED TYPE, PLANAR PASSIVATION TYPE

GATE CHARACTERISTICS

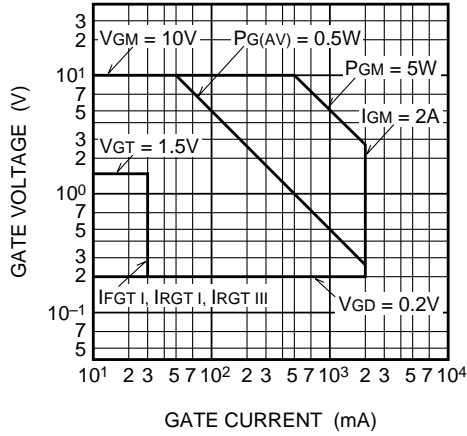

GATE TRIGGER CURRENT VS. JUNCTION TEMPERATURE

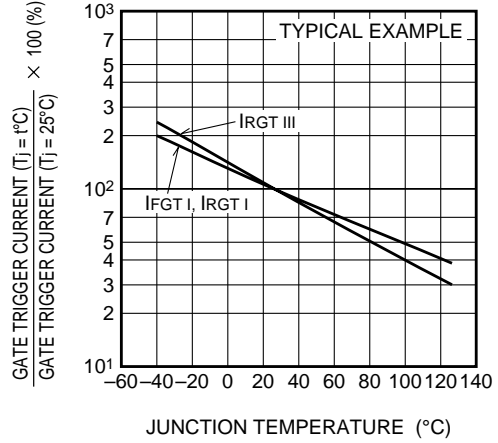

GATE TRIGGER VOLTAGE VS. JUNCTION TEMPERATURE

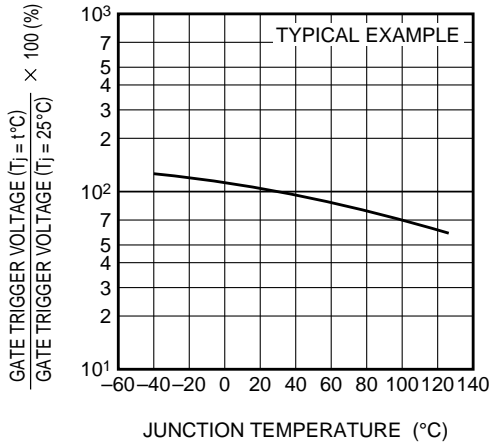

MAXIMUM TRANSIENT THERMAL IMPEDANCE CHARACTERISTICS (JUNCTION TO CASE)

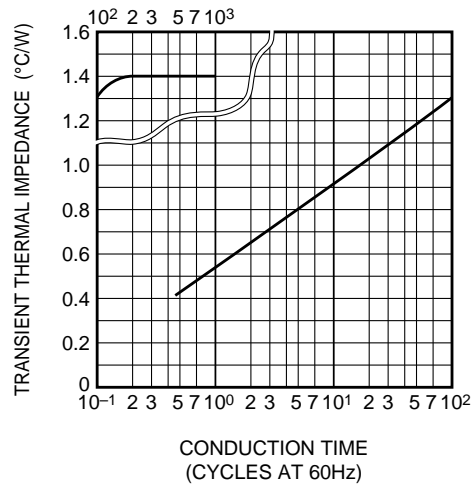

MAXIMUM ON-STATE POWER DISSIPATION

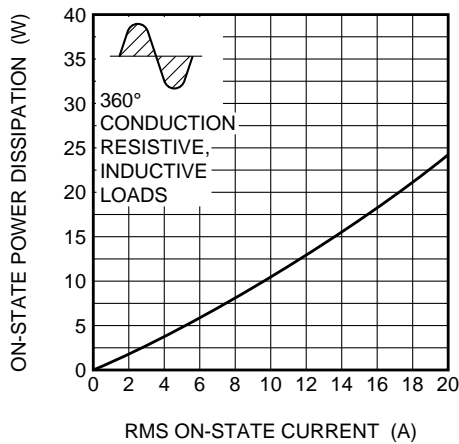

ALLOWABLE CASE TEMPERATURE VS. RMS ON-STATE CURRENT

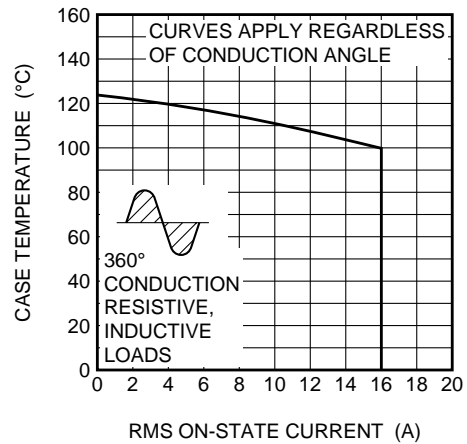

BCR16CM

MEDIUM POWER USE

NON-INSULATED TYPE, PLANAR PASSIVATION TYPE

ALLOWABLE AMBIENT TEMPERATURE VS. RMS ON-STATE CURRENT

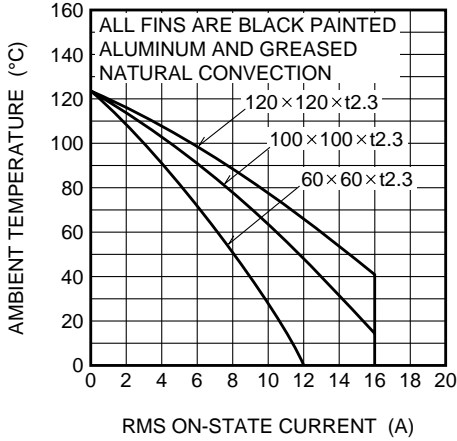

ALLOWABLE AMBIENT TEMPERATURE VS. RMS ON-STATE CURRENT

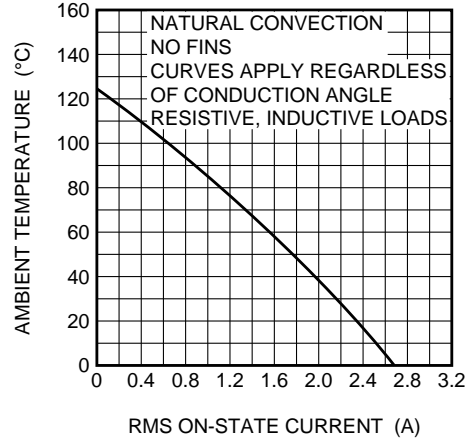

REPETITIVE PEAK OFF-STATE CURRENT VS. JUNCTION TEMPERATURE

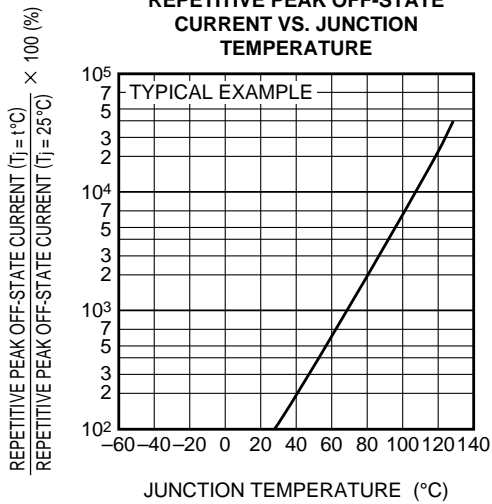

HOLDING CURRENT VS. JUNCTION TEMPERATURE

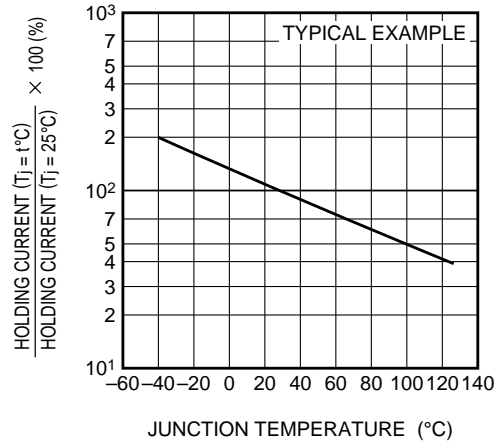

LATCHING CURRENT VS. JUNCTION TEMPERATURE

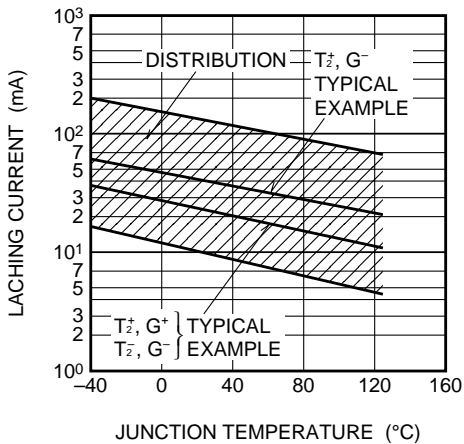

BREAKOVER VOLTAGE VS. JUNCTION TEMPERATURE

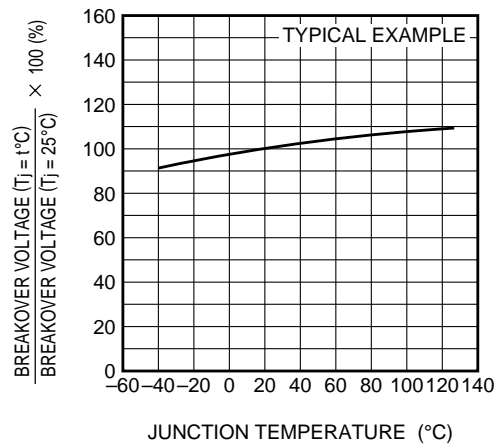

BCR16CM

MEDIUM POWER USE

NON-INSULATED TYPE, PLANAR PASSIVATION TYPE

BREAKEOVER VOLTAGE VS. RATE OF RISE OF OFF-STATE VOLTAGE

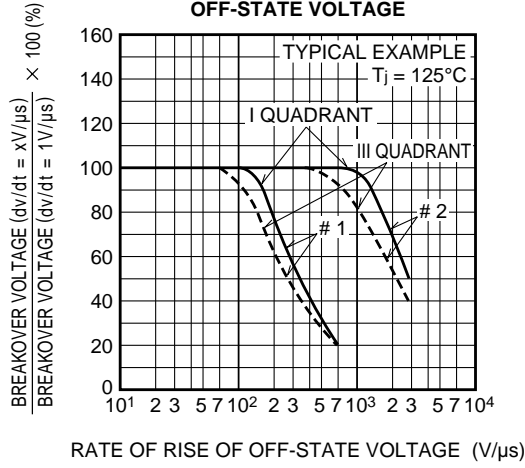

COMMUTATION CHARACTERISTICS

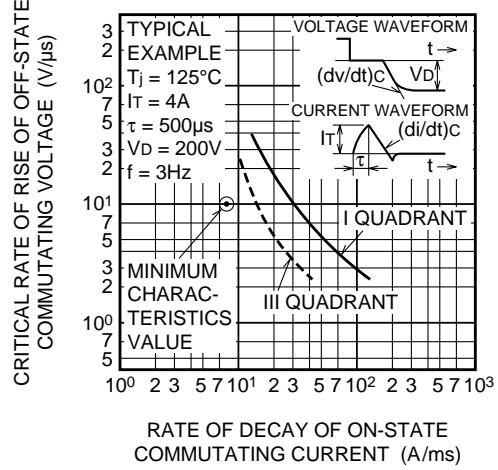

GATE TRIGGER CURRENT VS. GATE CURRENT PULSE WIDTH

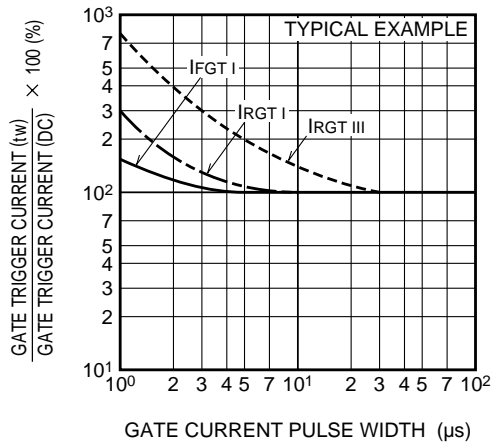

GATE TRIGGER CHARACTERISTICS TEST CIRCUITS

