

OUTLINE DRAWING

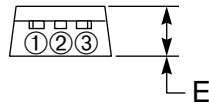

CONNECTION DIAGRAM

- ① T1 TERMINAL
- ② T2 TERMINAL
- ③ GATE
- ④ T2 TERMINAL

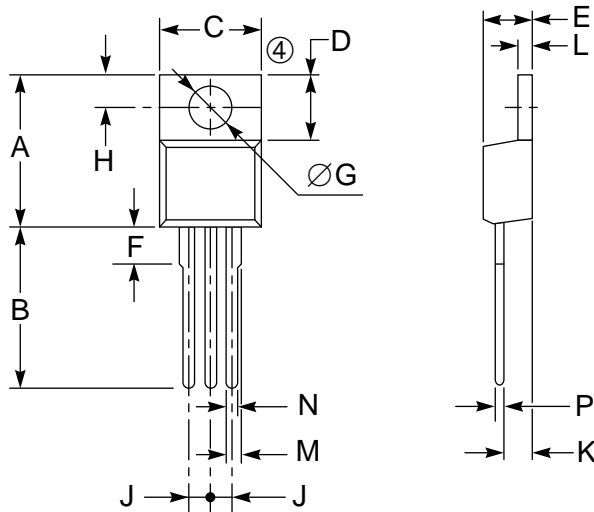
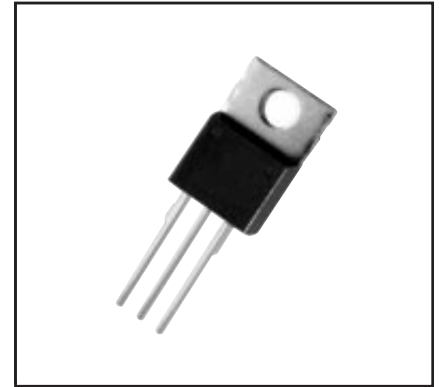
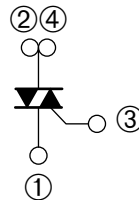

Description:

A triac is a solid state silicon AC switch which may be gate triggered from an off-state to an on-state for either polarity of applied voltage.

Features:

- Glass Passivation
- Selected for Inductive Loads

Applications:

- AC Switch
- Heating
- Motor Controls
- Switch Mode Power Supply
- Lighting
- Solid State Relay

Ordering Information:

Example: Select the complete eight, nine or ten digit part number you desire from the table - i.e. BCR16CM-8 is a 400 Volt, 16 Ampere Triac

Outline Drawing (Conforms to TO-220)

Dimensions	Inches	Millimeters
A	0.63 Max.	16.0 Max.
B	0.49 Max.	12.5 Max.
C	0.41 Max.	10.5 Max.
D	0.28	7.0
E	0.18	4.5
F	0.15 Max.	3.8 Max.
G	0.142 ± 0.008 Dia.	3.6 ± 0.2 Dia.
H	0.125 ± 0.008	3.2 ± 0.2

Dimensions	Inches	Millimeters
J	0.99	2.54
K	0.10	2.6
L	0.051	1.3
M	0.051	1.3
N	0.039	1.0
P	0.031	0.8
Q	0.020	0.5

Type	V _{DRM} Volts	Code	Inductive Load*
BCR16CM	400	-8	L
	600	-12	

*For inductive load, add L.



Powerex, Inc., 200 Hillis Street, Youngwood, Pennsylvania 15697-1800 (412) 925-7272

BCR16CM

Triac

16 Amperes/400-600 Volts

Absolute Maximum Ratings, $T_a = 25\text{ }^\circ\text{C}$ unless otherwise specified

Ratings	Symbol	BCR16CM-8	BCR16CM-12	Units
Repetitive Peak Off-state Voltage	V_{DRM}	400	600	Volts
Non-repetitive Peak Off-state Voltage	V_{DSM}	500	720	Volts
On-state Current, $T_c = 100^\circ\text{C}$	$I_{T(RMS)}$	16	16	Amperes
Non-repetitive Peak Surge, One Cycle (60 Hz)	I_{TSM}	170	170	Amperes
I^2t for Fusing, $t = 8.3\text{ msec}$	I^2t	121	121	A^2sec
Peak Gate Power Dissipation, 20 μsec	P_{GM}	5	5	Watts
Average Gate Power Dissipation	$P_{G(avg)}$	0.5	0.5	Watts
Peak Gate Current	I_{GM}	2	2	Amperes
Peak Gate Voltage	V_{GM}	10	10	Volts
Storage Temperature	T_{stg}	-40 to 125	-40 to 125	$^\circ\text{C}$
Operating Temperature	T_j	-40 to 125	-40 to 125	$^\circ\text{C}$
Weight	–	2.3	2.3	Grams



Powerex, Inc., 200 Hillis Street, Youngwood, Pennsylvania 15697-1800 (412) 925-7272

BCR16CM

Triac

16 Amperes/400-600 Volts

Electrical and Thermal Characteristics, $T_j = 25\text{ }^\circ\text{C}$ unless otherwise specified

Characteristics	Symbol	Test Conditions (Trigger Mode)				BCR16CM			Units
		V_D	R_L	R_G	T_j	Min.	Typ.	Max.	
Gate Parameters									
DC Gate Trigger Current									
MT2+ Gate+	I_{GT}	6V	6 Ω	330 Ω	25 $^\circ\text{C}$	–	–	30	mA
MT2+ Gate–		6V	6 Ω	330 Ω	25 $^\circ\text{C}$	–	–	30	mA
MT2– Gate–		6V	6 Ω	330 Ω	25 $^\circ\text{C}$	–	–	30	mA
DC Gate Trigger Voltage									
MT2+ Gate+	V_{GT}	6V	6 Ω	330 Ω	25 $^\circ\text{C}$	–	–	1.5	Volts
MT2+ Gate–		6V	6 Ω	330 Ω	25 $^\circ\text{C}$	–	–	1.5	Volts
MT2– Gate–		6V	6 Ω	330 Ω	25 $^\circ\text{C}$	–	–	1.5	Volts
DC Gate Non-trigger Voltage									
All	V_{GD}	$1/2 V_{DRM}$	–	–	125 $^\circ\text{C}$	0.2	–	–	Volts

BCR16CM

Triac

16 Amperes/400-600 Volts

Electrical and Thermal Characteristics, $T_j = 25\text{ }^\circ\text{C}$ unless otherwise specified

Characteristics	Symbol	Test Conditions	Min.	Typ.	Max.	Units
Thermal Resistance, Junction-to-case	$R_{th(j-c)}$	–	–	–	1.4	$^\circ\text{C/W}$
Voltage – Blocking State Repetitive Off-state Current	I_{DRM}	$V_D = V_{DRM}$, $T_j = 125^\circ\text{C}$	–	–	2	mA
Current – Conducting State Peak On-state Voltage	V_{TM}	$T_c = 25^\circ\text{C}$, $I_{TM} = 25\text{A}$	–	–	1.5	Volts
Critical Rate-of-rise of Commutating Off-state Voltage (Commutating dv/dt) ▲ for inductive load (L) (Switching)	$(dv/dt)_C$	–	–	–	–	$\text{V}/\mu\text{s}$

Δ Part Number	V_{DRM} (Volts)	Commutating dv/dt , $(dv/dt)_C$ ($\text{V}/\mu\text{sec}$)		Test Condition	Commutating Voltage & Current Waveform (Inductive Load)
		Load Type	Minimum		
BCR16CM-8L	400	L	10	$T_j = 125^\circ\text{C}$,	
BCR16CM-12L	600	L	10	Rate of Decay On-state Commutating Current $(di/dt)_C = -8\text{A/msec}$; Peak Off-state Voltage $V_D = 400\text{V}$	

BCR16CM

Triac

16 Amperes/400-600 Volts

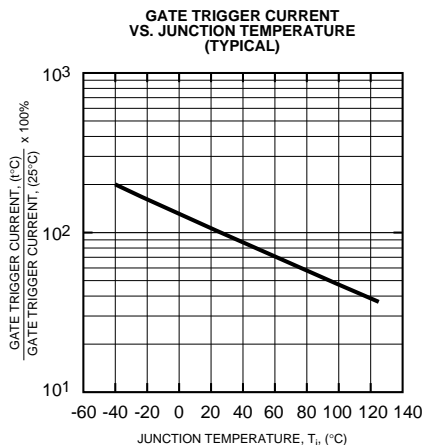
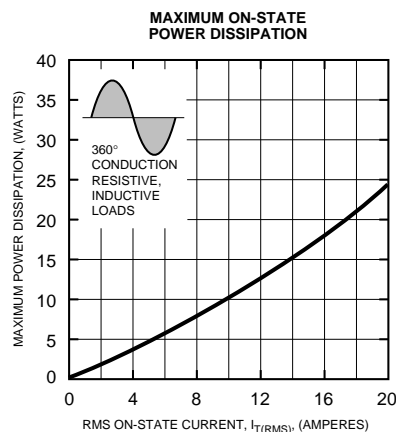
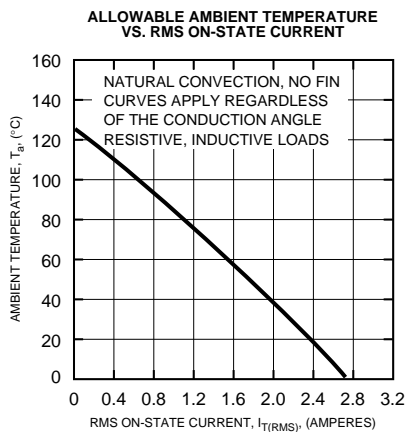
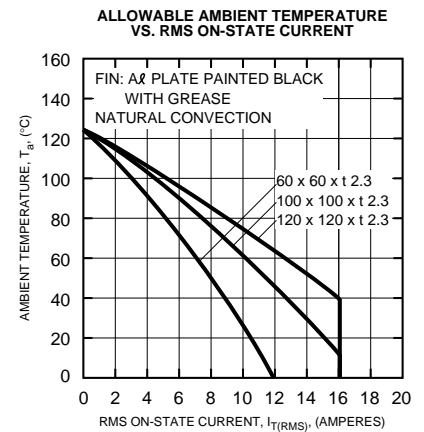
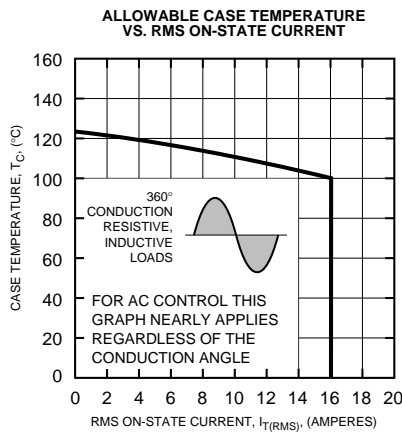
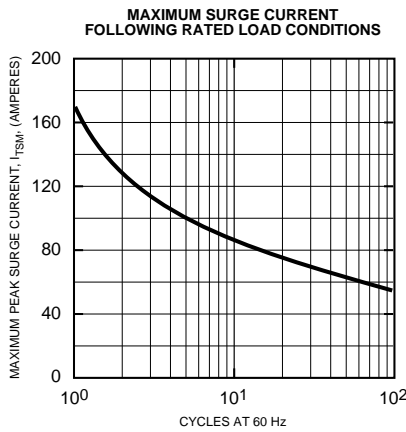
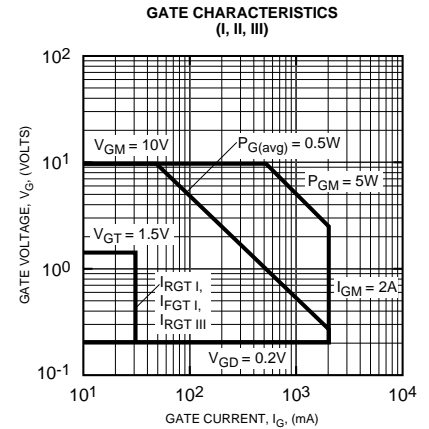
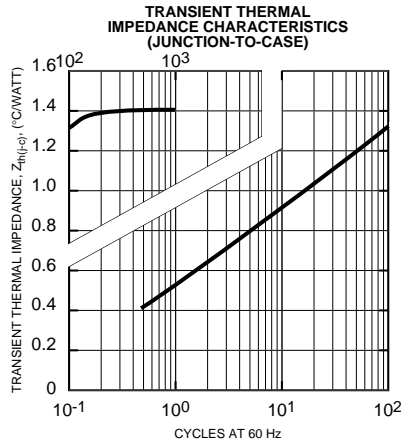
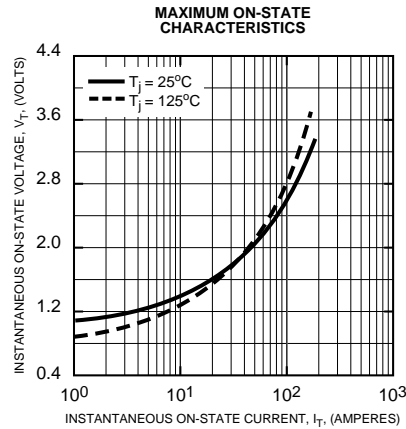

BCR16CM

Triac

16 Amperes/400-600 Volts

GATE TRIGGER VOLTAGE VS. JUNCTION TEMPERATURE (TYPICAL)

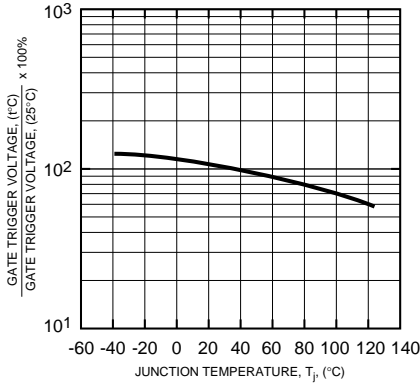

HOLDING CURRENT VS. JUNCTION TEMPERATURE (TYPICAL)

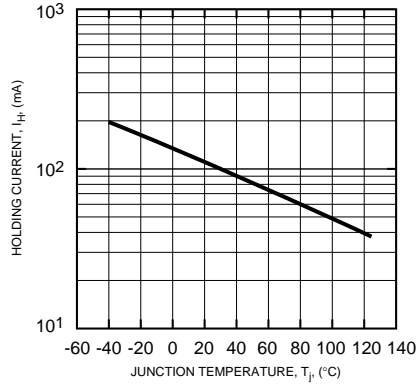

BREAKOVER VOLTAGE VS. JUNCTION TEMPERATURE (TYPICAL)

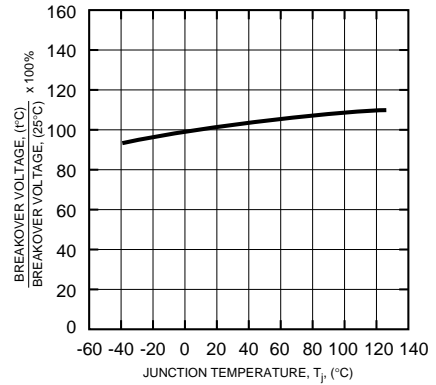

BREAKOVER VOLTAGE VS. RATE OF RISE OF OFF-STATE VOLTAGE (TYPICAL)

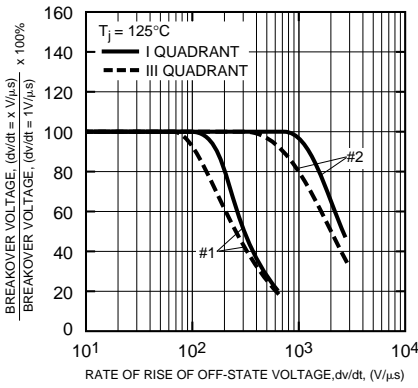

REPETITIVE PEAK OFF-STATE CURRENT VS. JUNCTION TEMPERATURE (TYPICAL)

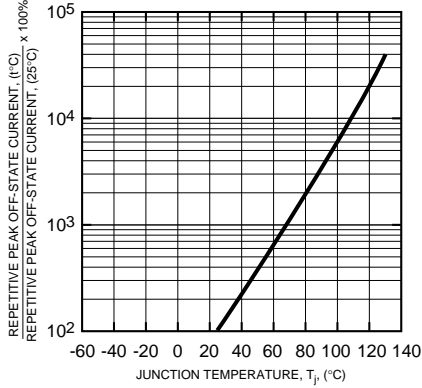

COMMUTATION CHARACTERISTICS (TYPICAL)

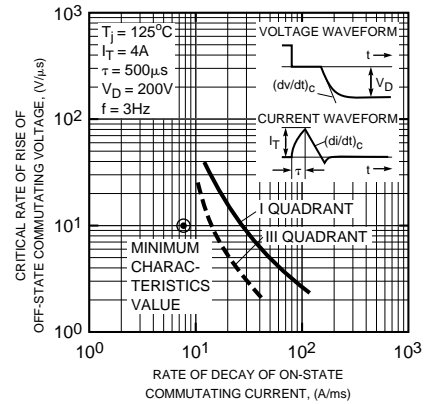

GATE TRIGGER CURRENT VS. GATE CURRENT PULSE WIDTH (TYPICAL)

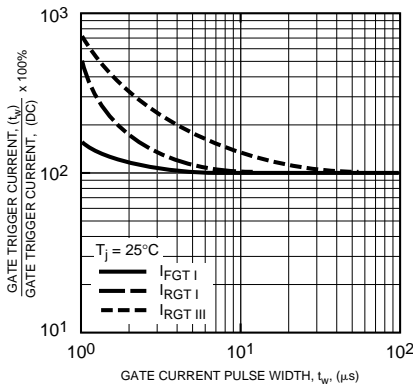

GATE TRIGGER CHARACTERISTICS TEST CIRCUITS

