

## NPN Silicon AF Transistors

**BCW 60**  
**BCX 70**

- For AF input stages and driver applications
- High current gain
- Low collector-emitter saturation voltage
- Low noise between 30 Hz and 15 kHz
- Complementary types: BCW 61, BCX 71 (PNP)

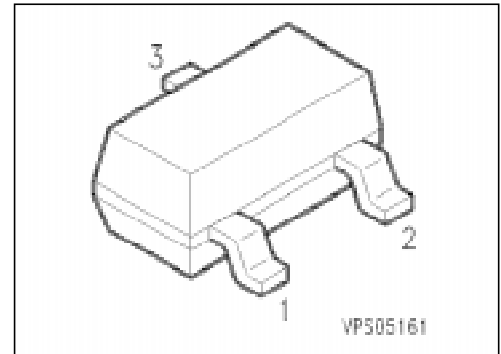

Type	Marking	Ordering Code (tape and reel)	Pin Configuration			Package <sup>1)</sup>
			1	2	3	
BCW 60 A	AAs	Q62702-C1517	B	E	C	SOT-23
BCW 60 B	ABs	Q62702-C1497				
BCW 60 C	ACs	Q62702-C1476				
BCW 60 D	ADs	Q62702-C1477				
BCW 60 FF	AFs	Q62702-C1529				
BCW 60 FN	ANs	Q62702-C1567				
BCX 70 G	AGs	Q62702-C1539				
BCX 70 H	AHs	Q62702-C1481				
BCX 70 J	AJs	Q62702-C1552				
BCX 70 K	AKs	Q62702-C1571				

<sup>1)</sup> For detailed information see chapter Package Outlines.

## Maximum Ratings

Parameter	Symbol	Values			Unit
		BCW 60	BCW 60 FF	BCX 70	
Collector-emitter voltage	$V_{CE0}$	32	32	45	V
Collector-base voltage	$V_{CB0}$	32	32	45	
Emitter-base voltage	$V_{EB0}$	5			
Collector current	$I_C$	100			mA
Peak collector current	$I_{CM}$	200			
Peak base current	$I_{BM}$	200			
Total power dissipation, $T_s = 71\text{ °C}$	$P_{tot}$	330			mW
Junction temperature	$T_j$	150			°C
Storage temperature range	$T_{stg}$	- 65 ... + 150			

## Thermal Resistance

Junction - ambient <sup>1)</sup>	$R_{th\ JA}$	≤ 310	K/W
Junction - soldering point	$R_{th\ JS}$	≤ 240	

<sup>1)</sup> Package mounted on epoxy pcb 40 mm × 40 mm × 1.5 mm/6 cm<sup>2</sup> Cu.

## Electrical Characteristics

at  $T_A = 25\text{ °C}$ , unless otherwise specified.

Parameter	Symbol	Values			Unit
		min.	typ.	max.	

### DC characteristics

Collector-emitter breakdown voltage $I_C = 10\text{ mA}$ BCW 60, BCW 60 FF BCX 70	$V_{(BR)CE0}$	32 45	— —	— —	V
Collector-base breakdown voltage $I_C = 10\text{ }\mu\text{A}$ BCW 60, BCW 60 FF BCX 70	$V_{(BR)CB0}$	32 45	— —	— —	
Emitter-base breakdown voltage $I_E = 1\text{ }\mu\text{A}$	$V_{(BR)EB0}$	5	—	—	
Collector cutoff current $V_{CB} = 32\text{ V}$ BCW 60, BCW 60 FF $V_{CB} = 45\text{ V}$ BCX 70 $V_{CB} = 32\text{ V}, T_A = 150\text{ °C}$ BCW 60, BCW 60 FF $V_{CB} = 45\text{ V}, T_A = 150\text{ °C}$ BCX 70	$I_{CB0}$	— — — —	— — — —	20 20 20 20	nA nA $\mu\text{A}$ $\mu\text{A}$
Emitter cutoff current $V_{EB} = 4\text{ V}$	$I_{EB0}$	—	—	20	nA
DC current gain <sup>1)</sup> $I_C = 10\text{ }\mu\text{A}, V_{CE} = 5\text{ V}$ BCW 60 A, BCX 70 G BCW 60 B, BCX 70 H BCW 60 FF, BCW 60 C, BCX 70 J BCW 60 FN, BCW 60 D, BCX 70 K $I_C = 2\text{ mA}, V_{CE} = 5\text{ V}$ BCW 60 A, BCX 70 G BCW 60 B, BCX 70 H BCW 60 FF, BCW 60 C, BCX 70 J BCW 60 FN, BCW 60 D, BCX 70 K $I_C = 50\text{ mA}, V_{CE} = 1\text{ V}$ BCW 60 A, BCX 70 G BCW 60 B, BCX 70 H BCW 60 FF, BCW 60 C, BCX 70 J BCW 60 FN, BCW 60 D, BCX 70 K	$h_{FE}$	20 20 40 100  120 180 250 380  50 70 90 100	140 200 300 460  170 250 350 500  — — — —	— — — —  220 310 460 630  — — — —	—

<sup>1)</sup> Pulse test:  $t \leq 300\text{ }\mu\text{s}, D \leq 2\%$ .

## Electrical Characteristics

at  $T_A = 25\text{ °C}$ , unless otherwise specified.

Parameter	Symbol	Values			Unit
		min.	typ.	max.	

### DC characteristics

Collector-emitter saturation voltage <sup>1)</sup> $I_C = 10\text{ mA}$ , $I_B = 0.25\text{ mA}$ $I_C = 50\text{ mA}$ , $I_B = 1.25\text{ mA}$	$V_{CEsat}$	–	0.12 0.20	0.25 0.55	V
Base-emitter saturation voltage <sup>1)</sup> $I_C = 10\text{ mA}$ , $I_B = 0.25\text{ mA}$ $I_C = 50\text{ mA}$ , $I_B = 1.25\text{ mA}$	$V_{BEsat}$	–	0.70 0.83	0.85 1.05	
Base-emitter voltage $I_C = 10\text{ }\mu\text{A}$ , $V_{CE} = 5\text{ V}$ $I_C = 2\text{ mA}$ , $V_{CE} = 5\text{ V}$ $I_C = 50\text{ mA}$ , $V_{CE} = 1\text{ V}$ <sup>1)</sup>	$V_{BE(on)}$	– 0.55 –	0.52 0.65 0.78	– 0.75 –	

### AC characteristics

Transition frequency $I_C = 20\text{ mA}$ , $V_{CE} = 5\text{ V}$ , $f = 100\text{ MHz}$	$f_T$	–	250	–	MHz
Output capacitance $V_{CB} = 10\text{ V}$ , $f = 1\text{ MHz}$	$C_{obo}$	–	3	–	pF
Input capacitance $V_{EB} = 0.5\text{ V}$ , $f = 1\text{ MHz}$	$C_{ibo}$	–	8	–	
Short-circuit input impedance $I_C = 2\text{ mA}$ , $V_{CE} = 5\text{ V}$ , $f = 1\text{ kHz}$ BCW 60 A, BCX 70 G BCW 60 B, BCX 70 H BCW 60 FF, BCW 60 C, BCX 70 J BCW 60 FN, BCW 60 D, BCX 70 K	$h_{11e}$	– – – –	2.7 3.6 4.5 7.5	– – – –	k $\Omega$
Open-circuit reverse voltage transfer ratio $I_C = 2\text{ mA}$ , $V_{CE} = 5\text{ V}$ , $f = 1\text{ kHz}$ BCW 60 A, BCX 70 G BCW 60 B, BCX 70 H BCW 60 FF, BCW 60 C, BCX 70 J BCW 60 FN, BCW 60 D, BCX 70 K	$h_{12e}$	– – –	1.5 2.0 2.0 3.0	– – –	$10^{-4}$

<sup>1)</sup> Pulse test:  $t \leq 300\text{ }\mu\text{s}$ ,  $D \leq 2\%$ .

## Electrical Characteristics

at  $T_A = 25\text{ }^\circ\text{C}$ , unless otherwise specified.

Parameter	Symbol	Values			Unit
		min.	typ.	max.	

## AC characteristics

Short-circuit forward current transfer ratio $I_C = 2\text{ mA}$ , $V_{CE} = 5\text{ V}$ , $f = 1\text{ kHz}$ BCW 60 A, BCX 70 G BCW 60 B, BCX 70 H BCW 60 FF, BCW 60 C, BCX 70 J BCW 60 FN, BCW 60 D, BCX 70 K	$h_{21e}$	—	200	—	—
Open-circuit output admittance $I_C = 2\text{ mA}$ , $V_{CE} = 5\text{ V}$ , $f = 1\text{ kHz}$ BCW 60 A, BCX 70 G BCW 60 B, BCX 70 H BCW 60 FF, BCW 60 C, BCX 70 J BCW 60 FN, BCW 60 D, BCX 70 K	$h_{22e}$	—	18	—	$\mu\text{S}$
Noise figure $I_C = 0.2\text{ mA}$ , $V_{CE} = 5\text{ V}$ , $R_S = 2\text{ k}\Omega$ $f = 1\text{ kHz}$ , $\Delta f = 200\text{ Hz}$ BCW 60 A to BCX 70 K BCW 60 FF, BCW 60 FN	$F$	—	2	—	dB
Equivalent noise voltage $I_C = 0.2\text{ mA}$ , $V_{CE} = 5\text{ V}$ , $R_S = 2\text{ k}\Omega$ $f = 10\text{ Hz} \dots 50\text{ Hz}$ BCW 60 FF, BCW 60 FN	$V_n$	—	—	0.135	$\mu\text{V}$

### Total power dissipation $P_{tot} = f(T_A^*; T_S)$

\* Package mounted on epoxy

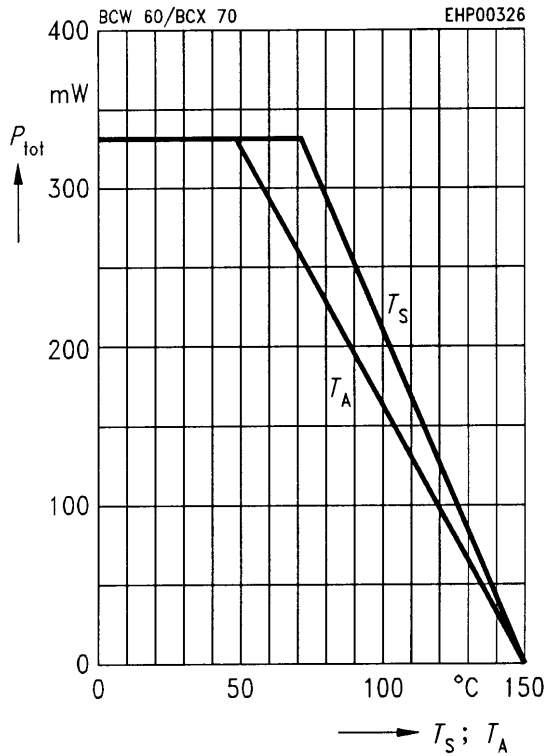

### Collector-base capacitance $C_{CB0} = f(V_{CB0})$

### Emitter-base capacitance $C_{EB0} = f(V_{EB0})$

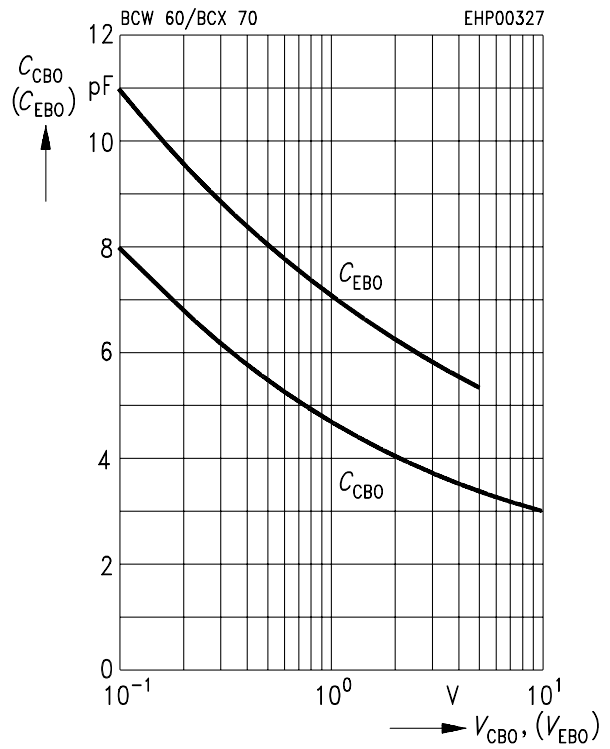

### Permissible pulse load $P_{tot max}/P_{tot DC} = f(t_p)$

### Transition frequency $f_T = f(I_C)$

$V_{CE} = 5 V$

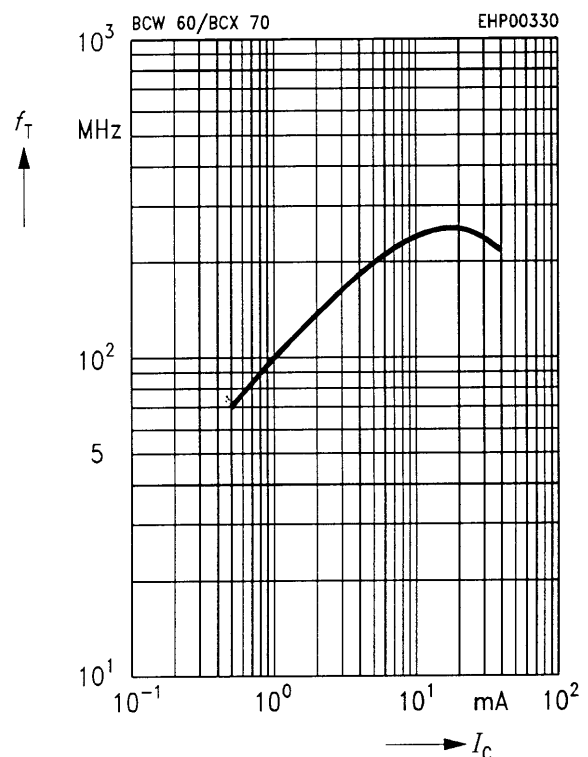
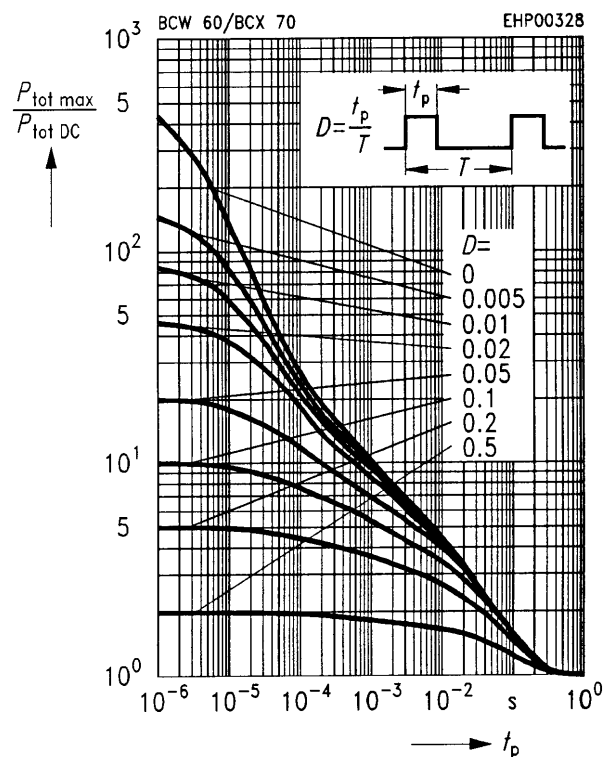

**Base-emitter saturation voltage**

$I_C = f(V_{BEsat})$

$h_{FE} = 40$

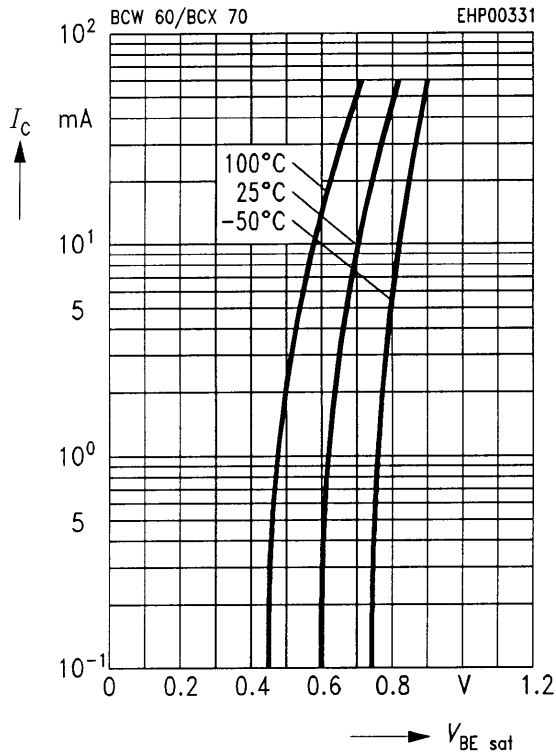

**Collector-emitter saturation voltage**

$I_C = f(V_{CEsat})$

$h_{FE} = 40$

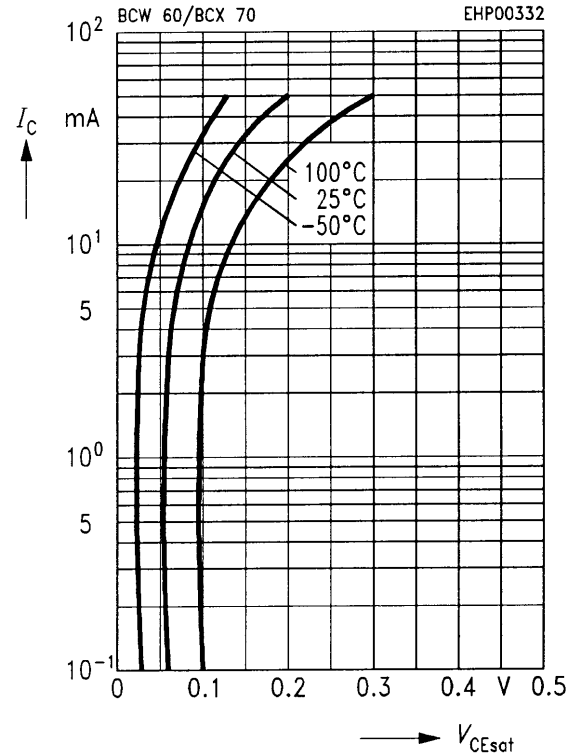

**Collector current  $I_C = f(V_{BE})$**

$V_{CE} = 5 V$

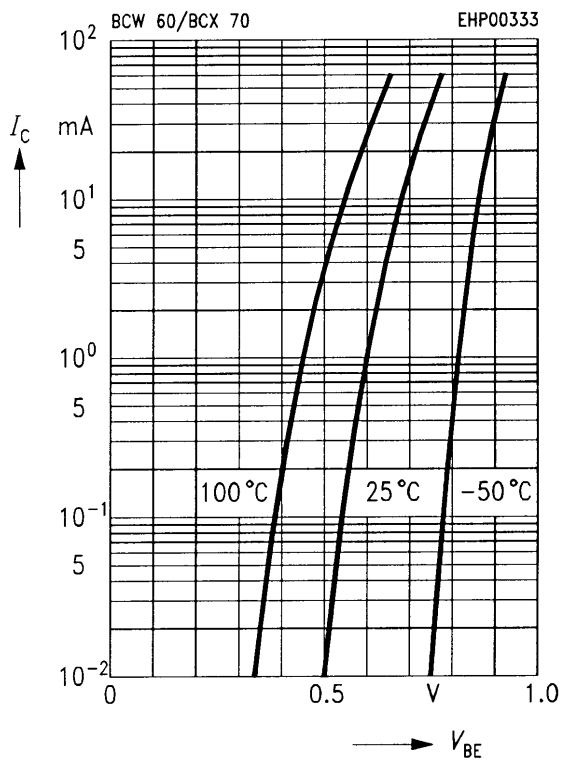

**DC current gain  $h_{FE} = f(I_C)$**

$V_{CE} = 5 V$

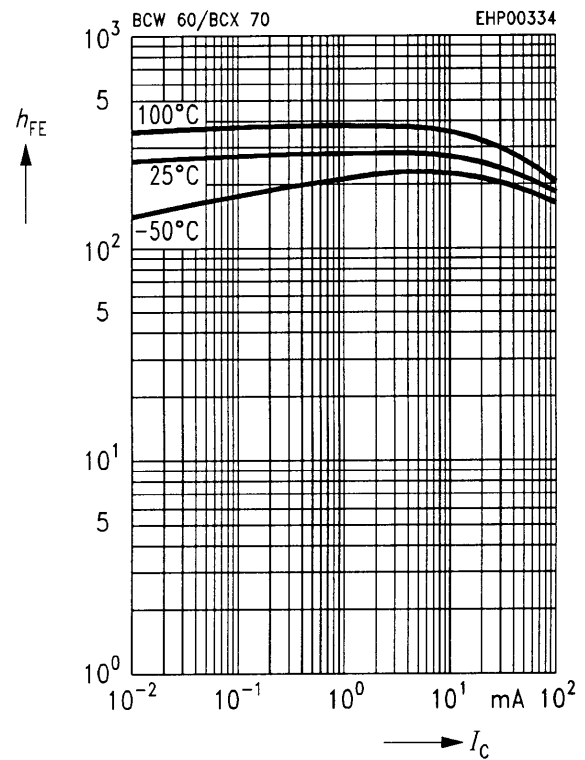

Collector cutoff current  $I_{CB0} = f(T_A)$

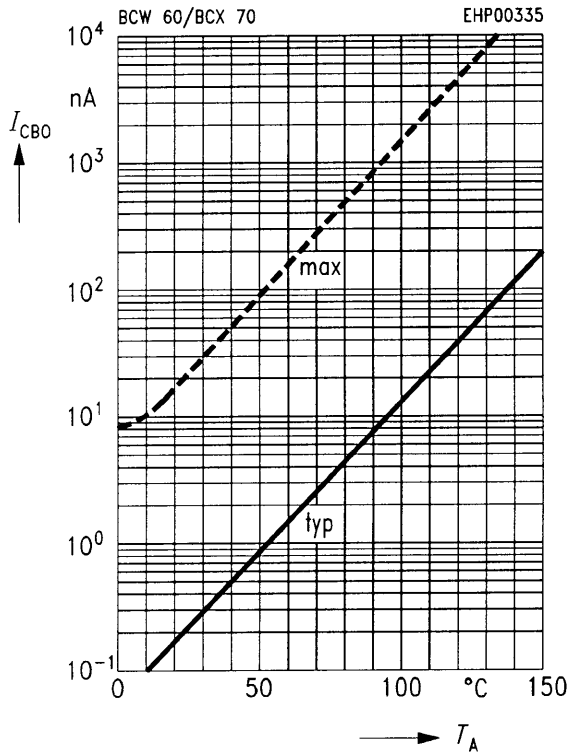

h parameter  $h_e = f(I_C)$

$V_{CE} = 5 V$

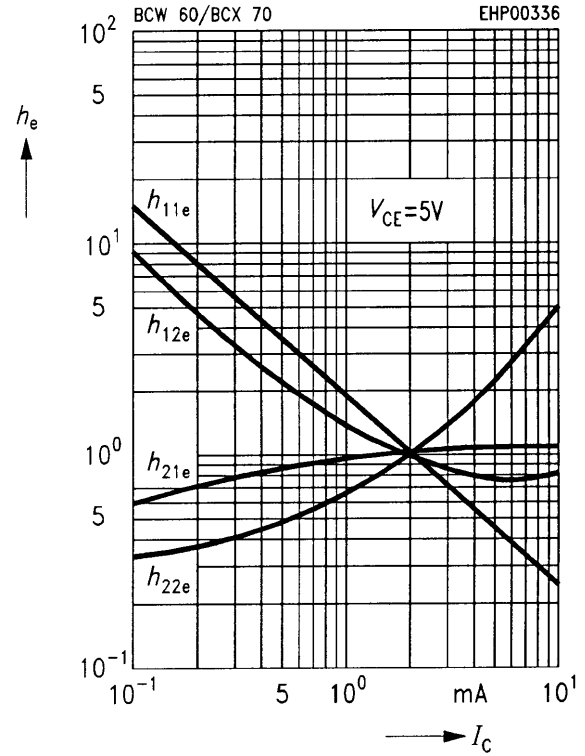

h parameter  $h_e = f(V_{CE})$

$I_C = 2 mA$

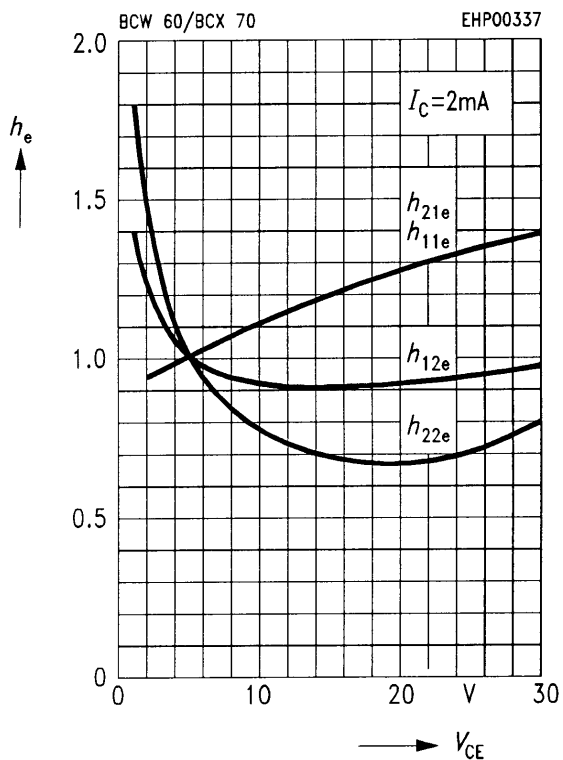

Noise figure  $F = f(V_{CE})$

$I_C = 0.2 mA, R_S = 2 k\Omega, f = 1 kHz$

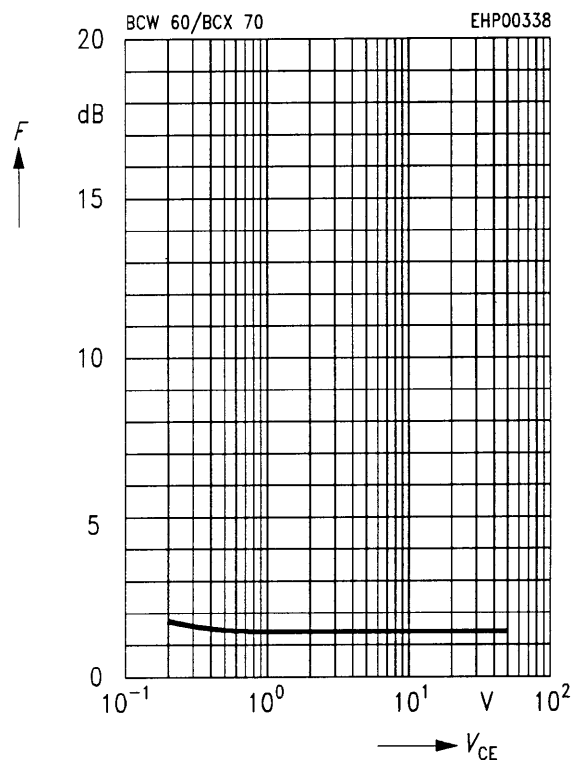



**Noise figure  $F = f(f)$**

$I_C = 0.2 \text{ mA}$ ,  $R_S = 2 \text{ k}\Omega$ ,  $V_{CE} = 5 \text{ V}$

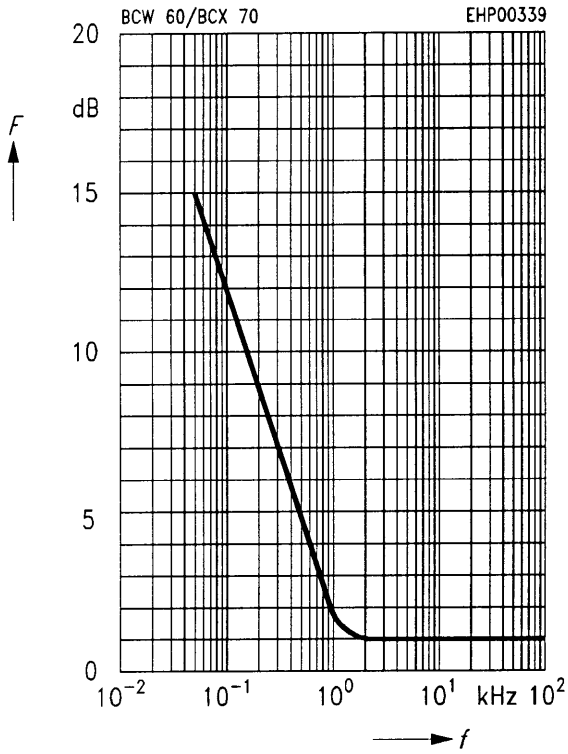

**Noise figure  $F = f(I_C)$**

$V_{CE} = 5 \text{ V}$ ,  $f = 120 \text{ Hz}$

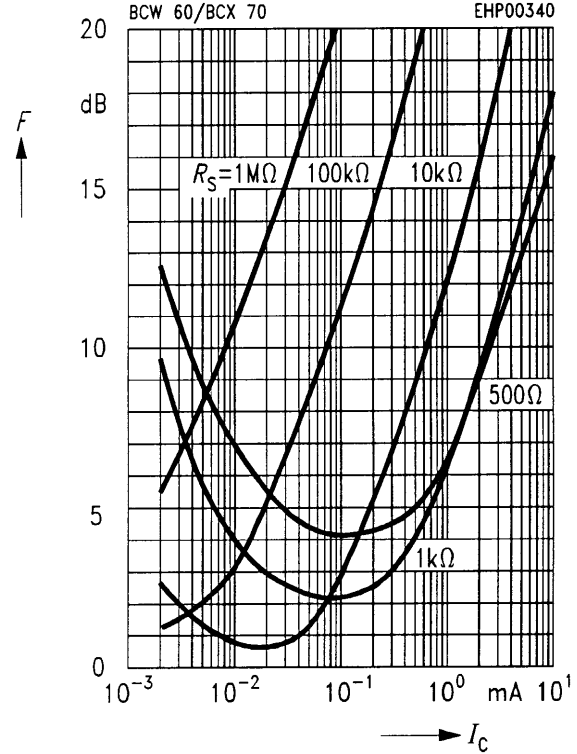

**Noise figure  $F = f(I_C)$**

$V_{CE} = 5 \text{ V}$ ,  $f = 1 \text{ kHz}$

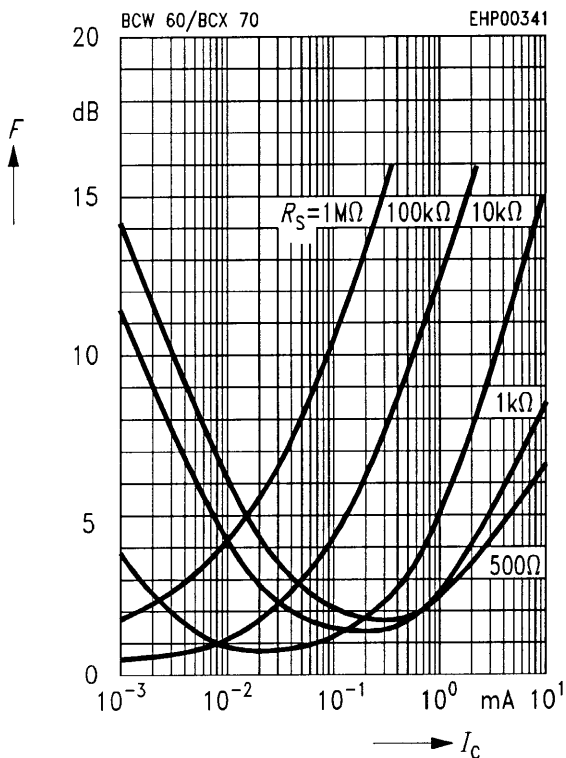

**Noise figure  $F = f(I_C)$**

$V_{CE} = 5 \text{ V}$ ,  $f = 10 \text{ kHz}$

