

**NPN Silicon AF and Switching Transistors**

- For general AF applications
- High breakdown voltage
- Low collector-emitter saturation voltage
- Complementary types: BCX42, BSS63 (PNP)

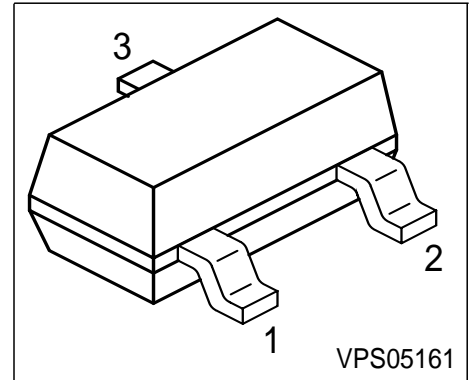

Type	Marking	Pin Configuration			Package
BCX41	EKs	1 = B	2 = E	3 = C	SOT23
BSS64	AMs	1 = B	2 = E	3 = C	SOT23

**Maximum Ratings**

Parameter	Symbol	BSS64	BCX41	Unit
Collector-emitter voltage	$V_{CEO}$	80	125	V
Collector-base voltage	$V_{CBO}$	120	125	
Emitter-base voltage	$V_{EBO}$	5	5	
DC collector current	$I_C$	800		mA
Peak collector current	$I_{CM}$	1		A
Base current	$I_B$	100		mA
Peak base current	$I_{BM}$	200		
Total power dissipation, $T_S = 79\text{ °C}$	$P_{tot}$	330		mW
Junction temperature	$T_j$	150		°C
Storage temperature	$T_{stg}$	-65 ... 150		

**Thermal Resistance**

Junction - soldering point <sup>1)</sup>	$R_{thJS}$	≤215	K/W
--	------------	------	-----

<sup>1)</sup>For calculation of  $R_{thJA}$  please refer to Application Note Thermal Resistance

**Electrical Characteristics** at  $T_A = 25^\circ\text{C}$ , unless otherwise specified.

Parameter	Symbol	Values			Unit	
		min.	typ.	max.		
<b>DC Characteristics</b>						
Collector-emitter breakdown voltage $I_C = 10\text{ mA}, I_B = 0$	BSS64 BCX41	$V_{(BR)CEO}$	80 125	- -	- -	V
Collector-base breakdown voltage $I_C = 100\ \mu\text{A}, I_B = 0$	BSS64 BCX41	$V_{(BR)CBO}$	120 125	- -	- -	
Emitter-base breakdown voltage $I_E = 10\ \mu\text{A}, I_C = 0$		$V_{(BR)EBO}$	5	-	-	
Collector cutoff current $V_{CB} = 80\text{ V}, I_E = 0$ $V_{CB} = 100\text{ V}, I_E = 0$	BSS64 BCX41	$I_{CBO}$	- -	- -	100 100	nA
Collector cutoff current $V_{CB} = 80\text{ V}, I_E = 0, T_A = 150\ ^\circ\text{C}$ $V_{CB} = 100\text{ V}, I_E = 0, T_A = 150\ ^\circ\text{C}$	BSS64 BCX41	$I_{CBO}$	- -	- -	20 20	$\mu\text{A}$
Emitter cutoff current $V_{EB} = 4\text{ V}, I_C = 0$		$I_{EBO}$	-	-	100	nA
Collector cutoff current $V_{CE} = 100\text{ V}, T_A = 85\ ^\circ\text{C}$ $V_{CE} = 100\text{ V}, T_A = 125\ ^\circ\text{C}$	BCX41 BCX41	$I_{CEO}$	- -	- -	10 75	$\mu\text{A}$
DC current gain 1) $I_C = 100\ \mu\text{A}, V_{CE} = 1\text{ V}$ $I_C = 1\text{ mA}, V_{CE} = 1\text{ V}$ $I_C = 4\text{ mA}, V_{CE} = 1\text{ V}$ $I_C = 10\text{ mA}, V_{CE} = 1\text{ V}$ $I_C = 20\text{ mA}, V_{CE} = 1\text{ V}$ $I_C = 100\text{ mA}, V_{CE} = 1\text{ V}$ $I_C = 200\text{ mA}, V_{CE} = 1\text{ V}$	BCX41 BSS64 BSS64 BSS64 BSS64 BCX41 BCX41	$h_{FE}$	25 - 20 - - 63 40	- 60 80 80 55 - -	- - - - - - -	-

 1) Pulse test:  $t \leq 300\ \mu\text{s}$ ,  $D = 2\%$

**Electrical Characteristics** at  $T_A = 25^\circ\text{C}$ , unless otherwise specified.

Parameter	Symbol	Values			Unit
		min.	typ.	max.	
<b>DC Characteristics</b>					
Collector-emitter saturation voltage <sup>1)</sup> $I_C = 300\text{ mA}, I_B = 30\text{ mA}$ BCX41	$V_{CEsat}$	-	-	0.9	V
$I_C = 4\text{ mA}, I_B = 0.4\text{ mA}$ BSS64		-	-	0.7	
$I_C = 50\text{ mA}, I_B = 15\text{ mA}$ BSS64		-	-	3	
Base-emitter saturation voltage 1) $I_C = 300\text{ mA}, I_B = 30\text{ mA}$ BCX41	$V_{BEsat}$	-	-	1.4	
<b>AC Characteristics</b>					
Transition frequency $I_C = 20\text{ mA}, V_{CE} = 5\text{ V}, f = 20\text{ MHz}$	$f_T$	-	100	-	MHz
Collector-base capacitance $V_{CB} = 10\text{ V}, f = 1\text{ MHz}$	$C_{cb}$	-	12	-	pF

**Total power dissipation  $P_{tot} = f(T_S)$**

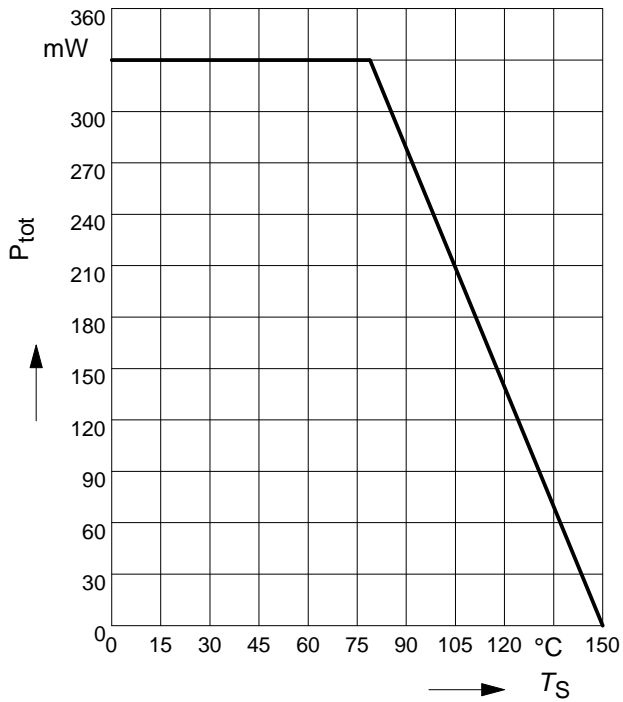

**Collector current  $I_C = f(V_{BE})$**

$V_{CE} = 1V$

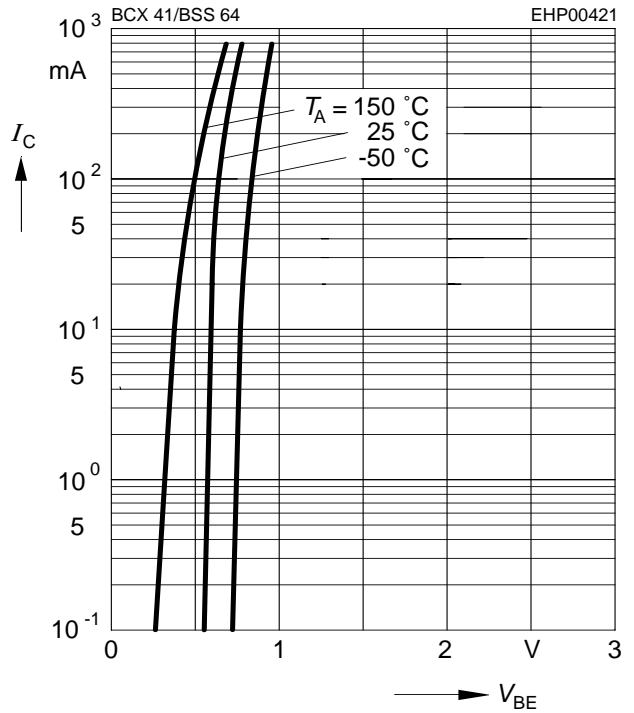

**Permissible pulse load**

$P_{totmax} / P_{totDC} = f(t_p)$

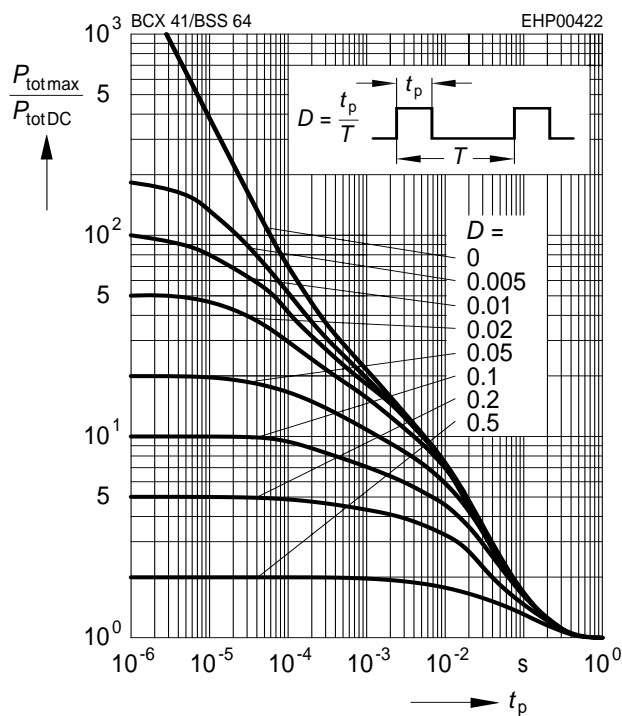

**Transition frequency  $f_T = f(I_C)$**

$V_{CE} = 5V$

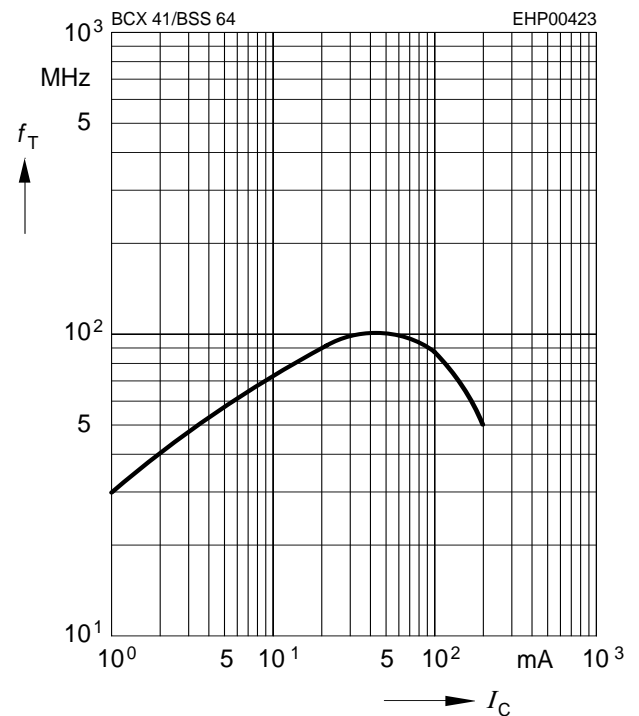

**Base-emitter saturation voltage**

$I_C = f(V_{BEsat}), h_{FE} = 10$

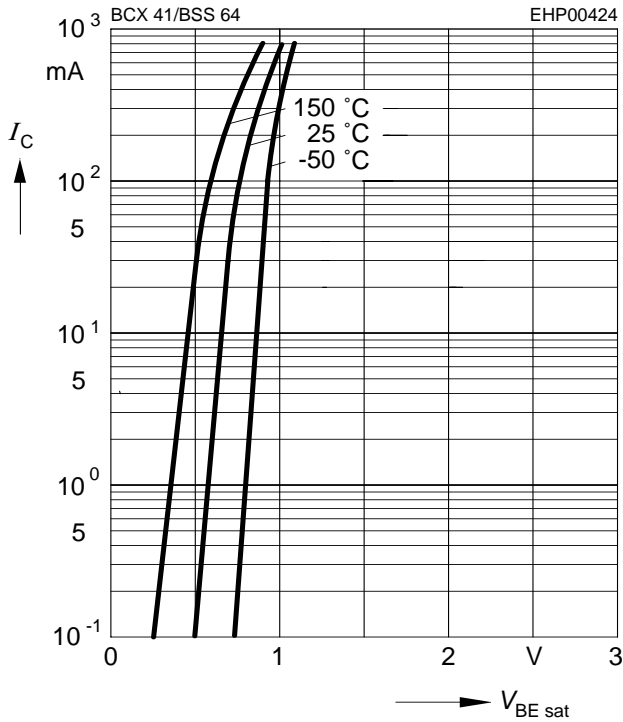

**Collector-emitter saturation voltage**

$I_C = f(V_{CEsat}), h_{FE} = 10$

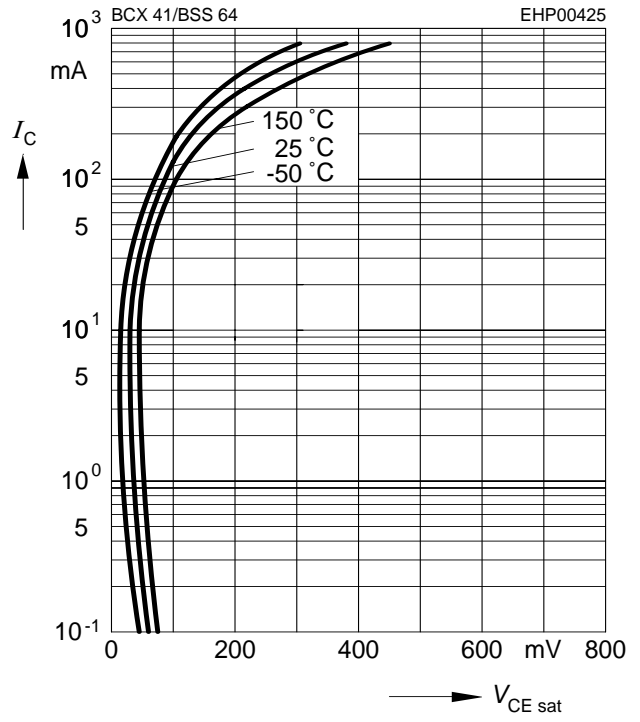

**Collector cutoff current  $I_{CBO} = f(T_A)$**

$V_{CB} = 80V$

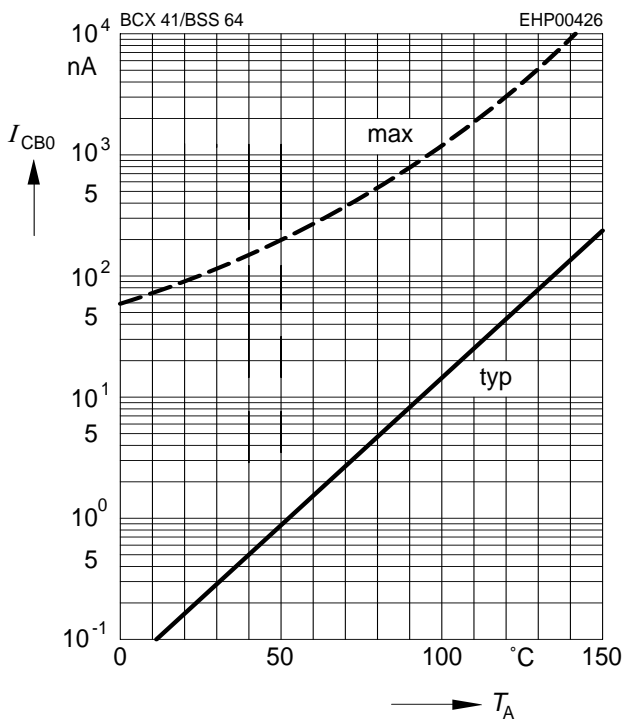

**DC current gain  $h_{FE} = f(I_C)$**

$V_{CE} = 1V$

