

1 . Features

- Wide 2 : 1 Input Range
- Low Ripple And Noise
- Input / Output Isolation 1.5K Vdc Or 3K Vdc
- 100% Burn-In
- Input - Filter
- Custom Design Available
- Net Weight : 12 g / 17 g Typical
- RoHS Converter Certified By SGS

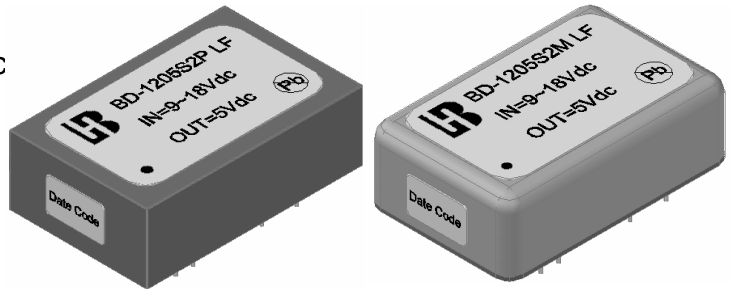

2 . Single Output Selection Guide

(Specifications typical at Ta= +25 , Nominal input voltage, Rated output current unless otherwise noted)

Model No.	Input Voltage (Vdc)	Output Voltage (Vdc)	Output Current (mA) Max	Input Current @No Load (mA) Typ.	Input Current @Max. Load (mA) Typ.	Output Ripple (mV) Max.	Load Regulation (%)Max.	Efficiency (%)Typ.
1) 2 W Single Output Series								
BD-1205S2 LF	9~18	5	400	9	235	50	± 0.5	71
BD-1215S2 LF		15	134	9	226	120	± 0.5	74
BD-2405S2 LF	18~36	5	400	6	116	50	± 0.5	72
BD-2412S2 LF		12	167	6	113	100	± 0.5	74
BD-2415S2 LF		15	134	6	109	120	± 0.5	77
BD-4805S2 LF	36~75	5	400	3	57	50	± 0.5	73
BD-4812S2 LF		12	167	3	55	100	± 0.5	76
2) 4 W Single Output Series								
BD-123R3S4 LF	9~18	3.3	1000	19	357	50	± 0.5	77
BD-1205S4 LF		5	800	20	422	50	± 0.5	79
BD-1212S4 LF		12	333	22	416	100	± 0.5	80
BD-2405S4 LF	18~36	5	800	10	211	50	± 0.5	79
BD-2412S4 LF		12	333	13	208	100	± 0.5	80
BD-2415S4 LF		15	267	15	201	120	± 0.5	83
BD-4805S4 LF	36~75	5	800	6	105	50	± 0.5	79
BD-4812S4 LF		12	333	7	104	100	± 0.5	80
3) 6 W Single Output Series								
BD-1205S6 LF	9~18	5	1200	19	633	50	± 0.5	79
BD-1215S6 LF		15	500	20	625	100	± 0.5	80



BD LF - Series

2 To 6 Watt Isolated DC-DC Converter
Single / Dual Output

BD-2405S6 LF	18~36	5	1200	10	316	50	± 0.5	79
BD-2412S6 LF		12	500	13	313	100	± 0.5	80
BD-2415S6 LF		15	400	13	313	120	± 0.5	80
BD-4805S6 LF	36~75	5	1200	6	158	50	± 0.5	79
BD-4812S6 LF		12	500	8	154	100	± 0.5	81

4) 2 W Dual Output Series

BD-1205D2 LF	9~18	± 5	± 200	9	225	50	± 2	74
BD-1212D2 LF		±12	± 83	9	215	100	± 2	77
BD-2405D2 LF	18~36	±5	± 200	6	110	50	± 2	76
BD-2412D2 LF		±12	± 83	7	106	100	± 2	78
BD-4805D2 LF	36~75	±5	± 200	3	56	50	± 2	75
BD-4812D2 LF		±12	± 83	3	53	100	± 2	78

5) 4 W Dual Output Series

BD-123R3D4 LF	9~18	± 3.3	± 500	20	367	50	± 2	75
BD-1205D4 LF		± 5	± 400	22	439	50	± 2	76
BD-2405D4 LF	18~36	± 5	± 400	13	219	50	± 2	76
BD-2412D4 LF		± 12	± 167	15	209	100	± 2	79
BD-2415D4 LF		± 15	± 133	17	208	120	± 2	80
BD-4805D4 LF	36~75	± 5	± 400	10	108	50	± 2	80
BD-4812D4 LF		± 12	± 167	11	106	100	± 2	79
BD-4815D4 LF		± 15	± 133	12	104	120	± 2	80

6) 6 W Dual Output Series

BD-1205D6 LF	9~18	± 5	± 600	22	658	50	± 2	76
BD-1212D6 LF		± 12	± 250	25	633	100	± 2	79
BD-2405D6 LF	18~36	± 5	± 600	13	321	50	± 2	78
BD-2412D6 LF		± 12	± 250	14	317	100	± 2	79
BD-2415D6 LF		± 15	± 200	15	313	120	± 2	80
BD-4805D6 LF	36~75	± 5	± 600	10	162	50	± 2	77
BD-4812D6 LF		± 12	± 250	13	156	100	± 2	80
BD-4815D6 LF		± 15	± 200	14	156	120	± 2	80

Notes :

1. Load regulation is for output current change from 0% to 100% Max. Load.

3 . Absolute Maximum Ratings

(Exceeding these values may damage the module. These are not continuous operating ratings)

Parameter	Condition	Min.	Typ.	Max.	Unit
Input Absolute Voltage Range	12V Input Model	-0.7	12	22.5	Vdc
	24V Input Model	-0.7	24	45	
	48V Input Model	-0.7	48	90	



Output Short Circuit Duration	Nominal Input Range	Indefinite & Auto-Restart			
Reverse Polarity Input Current Limit	---	---	---	1	A
Operation Temperature (Ambient Temperature)	Output Full Load	-25	---	+71	
Storage Temperature		-55	---	+105	

4 . Nominal Input/Output Electrical Specifications

(Specifications typical at Ta= +25 ,Nominal input voltage, Rated output current unless otherwise noted)

Parameter	Condition	Min.	Typ.	Max.	Unit
Input Voltage Range	12V Input Model	9	12	18	Vdc
	24V Input Model	18	24	36	
	48V Input Model	36	48	75	
Line Regulation	Output Full Load	---	---	± 0.5	%
Load Regulation	Single Output Model	---	---	± 0.5	
	Dual Output Model			± 2	
Output Voltage Accuracy	Nominal Input	---	± 1.0	± 2.0	
Output Voltage Balance	Dual Output Same Load	---	---	± 1.0	
Switching Frequency	Nominal Input	---	250	---	KHz
Temperature Coefficient		---	± 0.01	± 0.02	% /
Isolation Voltage	Standard Series	1500	---	---	Vdc
	High Isolation Series	3000	---	---	
Isolation Resistance	500 Vdc	1000	---	---	M
Isolation Capacitance	1KHz / 250mV rms	---	350	---	pF

5 . General Specification

Parameter	Specification	Condition
Isolation Voltage	1500 / 3000 Vdc	Test Duration 60 Seconds / 0.5 mA
Isolation Resistance	1000 M Min.	@ 500 Vdc
Operating Temperature (1)	-25 ~ +71	@ Ambient Temperature With Natural Convection
Operating Temperature (2)	-25 ~ +95	@ Case Surface Temperature
Storage Temperature	-55 ~ +105	---
Humidity	Up To 90 %	---
Cooling	Free Air Convection	---
Case Type	Plastic, Metal	---



6 . Ordering Information

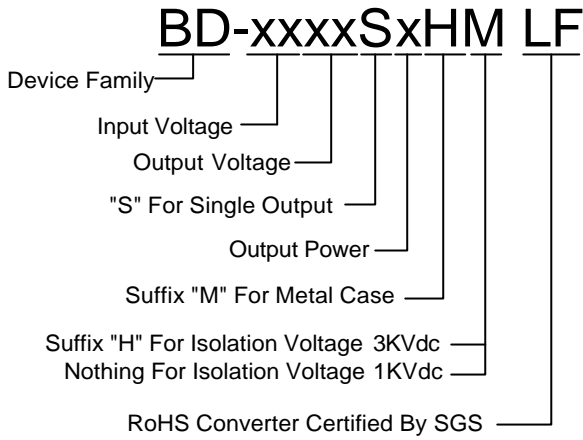

7 . Power Derating Curve

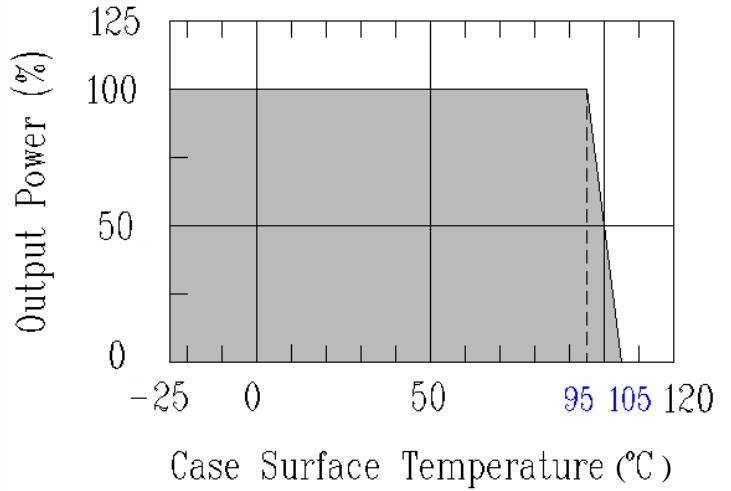

8 . Efficiency & Output Load Chart

Vout= 5 Vdc

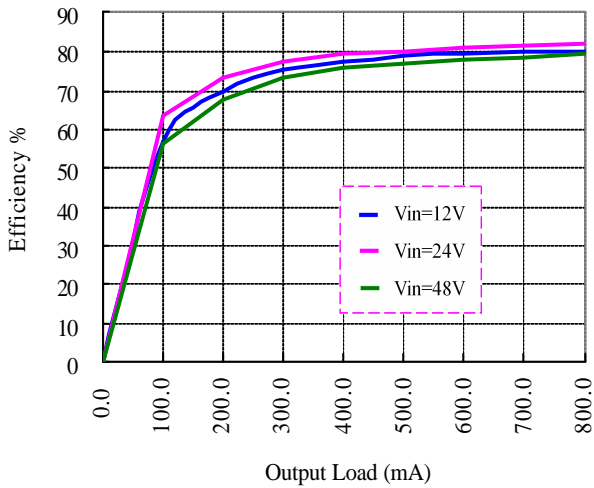

Vout= 12 Vdc

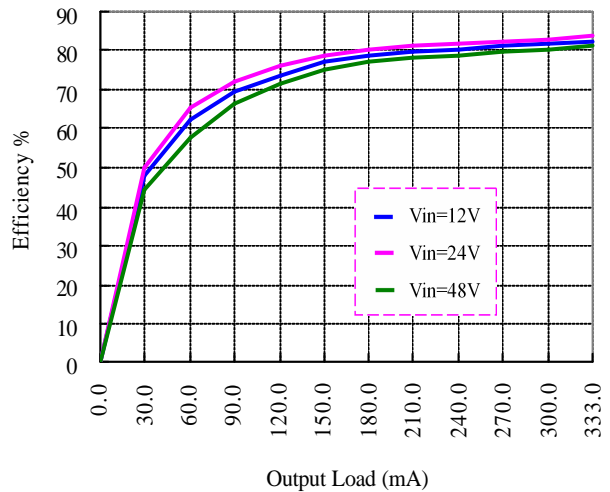

9 . Mechanical Dimension

Metal Case Model

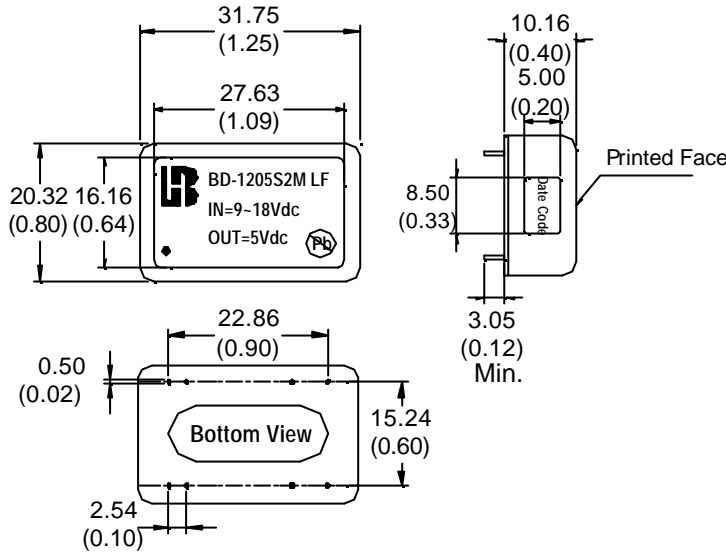

Pin	Single Output		Pin
1	No Pin	No Pin	24
2	-Vin	+Vin	23
3			22
4			21
5	No Pin	No Pin	20
6			19
7			18
8			17
9	N.C.	-Vo	16
10	No Pin	No Pin	15
11	N.C.	+Vo	14
12	No Pin	No Pin	13

Pin	Dual Output		Pin
1	No Pin	No Pin	24
2	-Vin	+Vin	23
3			22
4			21
5	No Pin	No Pin	20
6			19
7			18
8			17
9	Common	Common	16
10	No Pin	No Pin	15
11	-Vo	+Vo	14
12	No Pin	No Pin	13

Units : mm (inch)
Tolerance : 0.xx ± 0.25 (0.xx ± 0.01)

Plastic Case Model

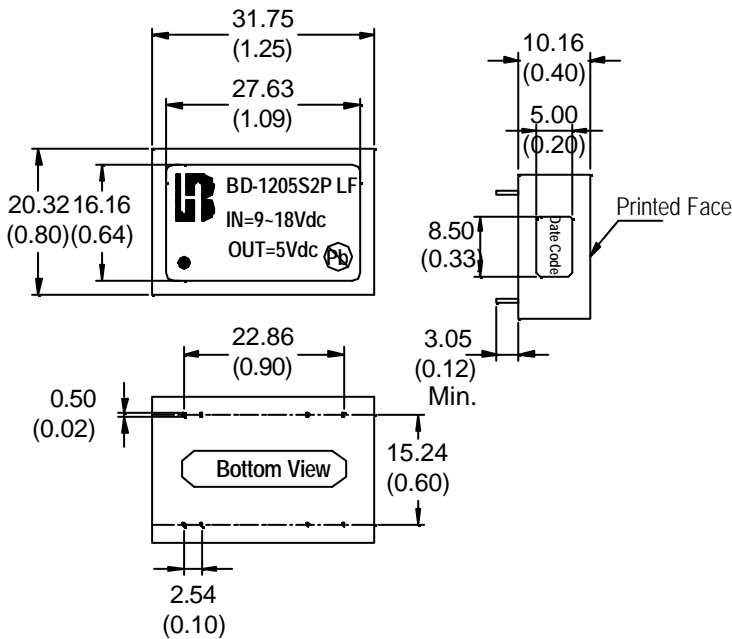

Pin	Single Output		Pin
1	No Pin	No Pin	24
2	-Vin	+Vin	23
3			22
4			21
5	No Pin	No Pin	20
6			19
7			18
8			17
9	N.C.	-Vo	16
10	No Pin	No Pin	15
11	N.C.	+Vo	14
12	No Pin	No Pin	13

Pin	Dual Output		Pin
1	No Pin	No Pin	24
2	-Vin	+Vin	23
3			22
4			21
5	No Pin	No Pin	20
6			19
7			18
8			17
9	Common	Common	16
10	No Pin	No Pin	15
11	-Vo	+Vo	14
12	No Pin	No Pin	13

Units : mm (inch)
Tolerance : 0.xx ± 0.25 (0.xx ± 0.01)



10 . Recommended Footprint Details

Metal Case Model

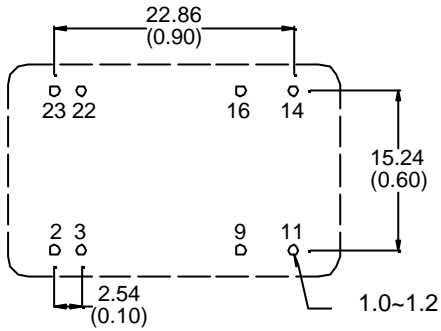

Plastic Case Model

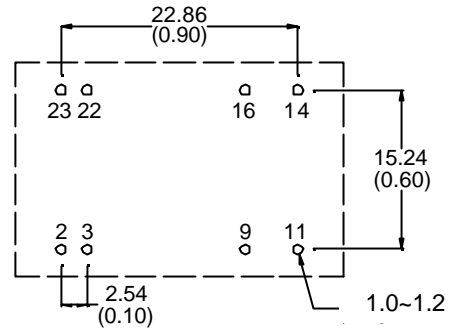

Units : mm (inch)
Tolerance : 0.xx ± 0.25 (0.xx ± 0.01)

11 . Package

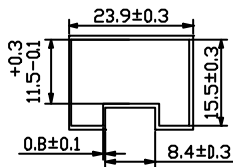

TUBE MECHANICAL DIMENSION

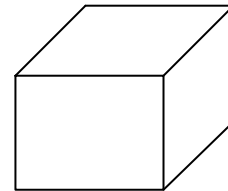
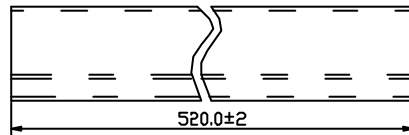

INNER CARTON:565*115*117

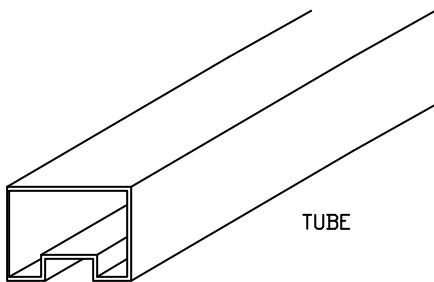

TUBE

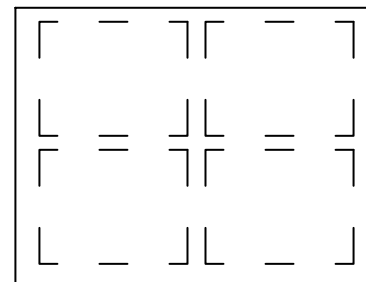

EXPORT CARTON:580*255*265

1. TUBE=15PCS
2. INNER CARTON=25 TUBE=25*15=375PCS
3. EXPORT CARTON=4 INNER CARTON=4*375=1500PCS