



- Designed to meet IEEE802.3ab requirement
- Primary inductance 350uH min with 8mA DC Bias
- RoHS Compliant.
- Operating temperature range:0°C to +70°C
- Storage temperature range:-25°C to +125°C

Electrical Specifications @ 25°C

Part Number	Turn Ratio		Insertion Loss 0.5~100MHz (dB Max)	Return Loss (dB Min)			Cross Talk (dB Min)		CMRR (dB Min) 0.50-100 MHz	CWW (pF Max)	LK (uH Max)	DCR (Ω Max)	Hi-Pot (Vrms)
	Tx	Rx		0.5-30 MHz	30.1-60 MHz	60.1-80 MHz	0.5-40 MHz	40.1-100 MHz					
BD20B12	1:1	1:1	-1.0	-16	-14	-12	-35	-30	-30	56	0.5	1.2	1500

Mechanical

Schematic

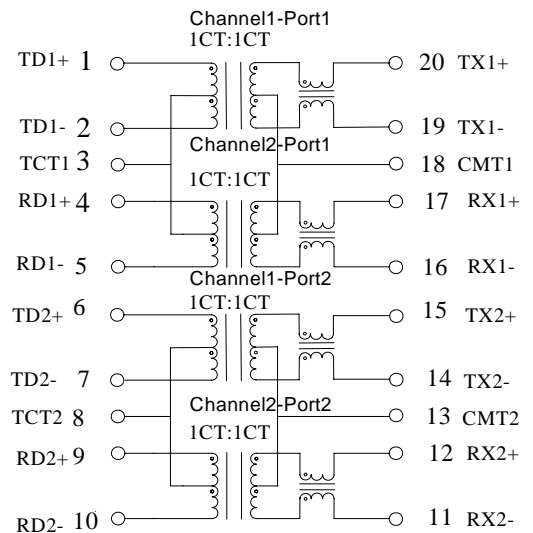
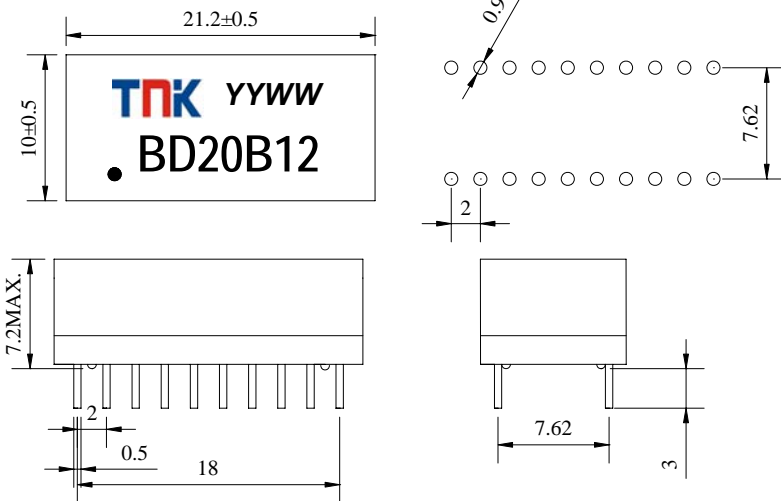

NOTE:

- 1、Dimensions:mm;
- 2、 Unless otherwise specified,tolerances:±0.25(mm);