

PNP Silicon RF Transistor

BF 550

- For common emitter amplifier stages up to 300 MHz
- For mixer applications in AM/FM radios and VHF TV tuners
- Low feedback capacitance due to shield diffusion
- Controlled low output conductance

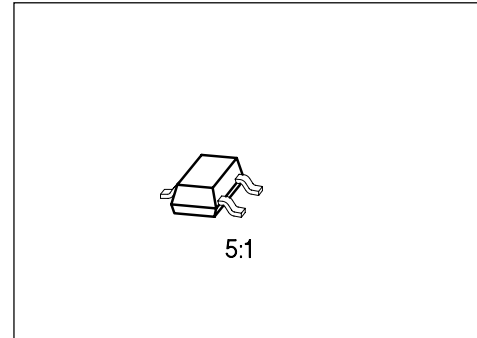

Type	Marking	Ordering Code (tape and reel)	Pin Configuration			Package ¹⁾
			1	2	3	
BF 550	LA	Q62702-F944	B	E	C	SOT-23

Maximum Ratings

Parameter	Symbol	Values	Unit
Collector-emitter voltage	V_{CE0}	40	V
Collector-base voltage	V_{CB0}	40	
Emitter-base voltage	V_{EB0}	4	
Collector current	I_C	25	mA
Base current	I_B	5	
Total power dissipation, $T_A \leq 25\text{ °C}$	P_{tot}	280	mW
Junction temperature	T_j	150	°C
Storage temperature range	T_{stg}	- 65 ... + 150	

Thermal Resistance

Junction - ambient ²⁾	$R_{th\ JA}$	≤ 450	K/W
----------------------------------	--------------	------------	-----

¹⁾ For detailed information see chapter Package Outlines.

²⁾ Package mounted on alumina 15 mm × 16.7 mm × 0.7 mm.

Electrical Characteristics

at $T_A = 25\text{ }^\circ\text{C}$, unless otherwise specified.

Parameter	Symbol	Values			Unit
		min.	typ.	max.	

DC Characteristics

Collector-emitter breakdown voltage $I_C = 1\text{ mA}, I_B = 0$	$V_{(BR)CE0}$	40	–	–	V
Collector-base breakdown voltage $I_C = 10\text{ }\mu\text{A}, I_E = 0$	$V_{(BR)CB0}$	40	–	–	
Emitter-base breakdown voltage $I_E = 10\text{ }\mu\text{A}, I_C = 0$	$V_{(BR)EB0}$	4	–	–	
Collector cutoff current $V_{CB} = 30\text{ V}, I_E = 0$	I_{CB0}	–	–	100	nA
DC current gain $I_C = 1\text{ mA}, V_{CE} = 10\text{ V}$	h_{FE}	50	–	250	–
Base-emitter voltage $I_C = 1\text{ mA}, V_{CE} = 10\text{ V}$	V_{BE}	–	0.72	–	V

AC Characteristics

Transition frequency $I_C = 1\text{ mA}, V_{CE} = 10\text{ V}, f = 100\text{ MHz}$	f_T	–	350	–	MHz
Collector-base capacitance $V_{CB} = 10\text{ V}, V_{BE} = 0\text{ V}, f = 1\text{ MHz}$	C_{cb}	–	0.33	–	pF
Collector-emitter capacitance $V_{CE} = 10\text{ V}, V_{BE} = 0\text{ V}, f = 1\text{ MHz}$	C_{ce}	–	0.67	–	
Noise figure $V_{CE} = 10\text{ V}$ $I_C = 1\text{ mA}, f = 100\text{ kHz}, R_S = 300\text{ }\Omega$ $I_C = 2\text{ mA}, f = 100\text{ MHz}, R_S = 60\text{ }\Omega$	F	–	2 3.4	–	dB
Y parameters , common emitter $I_C = 1\text{ mA}, V_{CE} = 10\text{ V}$ $f = 0.45 \dots 10\text{ MHz}$	g_{11e}	–	550	–	μS
	C_{11e}	–	17	–	pF
	$ y_{21e} $	–	35	–	mS
	C_{22e}	–	1.3	–	pF
$f = 500\text{ kHz}$	g_{22e}	–	5	8	μS
$f = 10\text{ MHz}$	g_{22e}	–	5	10	μS

Total power dissipation $P_{tot} = f(T_A)$

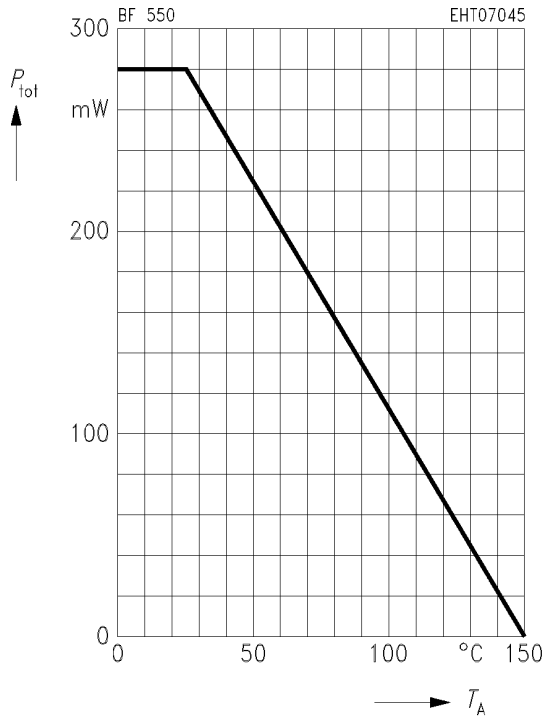

DC current gain $h_{FE} = f(I_C)$

$V_{CE} = 10\text{ V}$

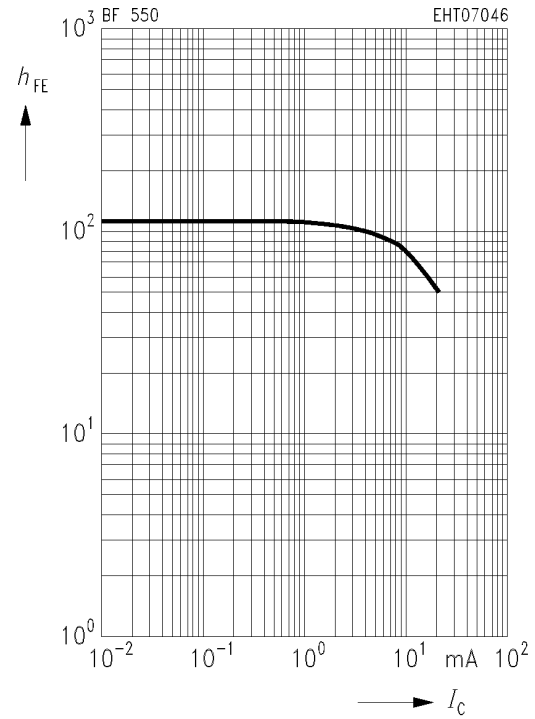

Collector current $I_C = f(V_{BE})$

$V_{CE} = 10\text{ V}$

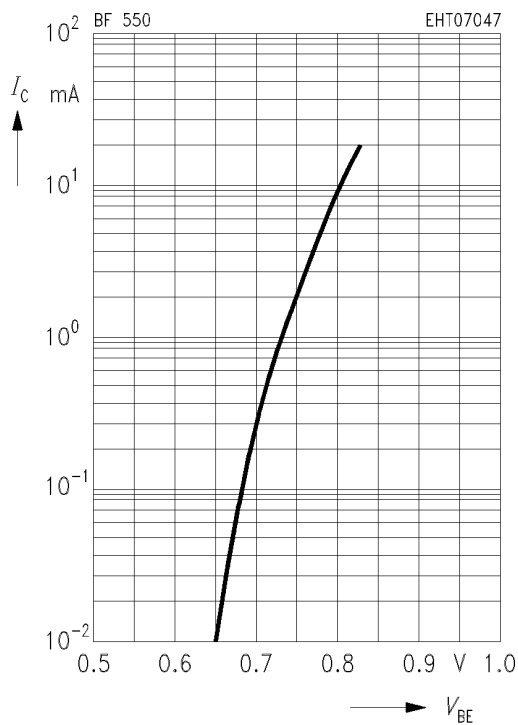

Collector-emitter saturation voltage $V_{CEsat} = f(I_C)$

$h_{FE} = 10$

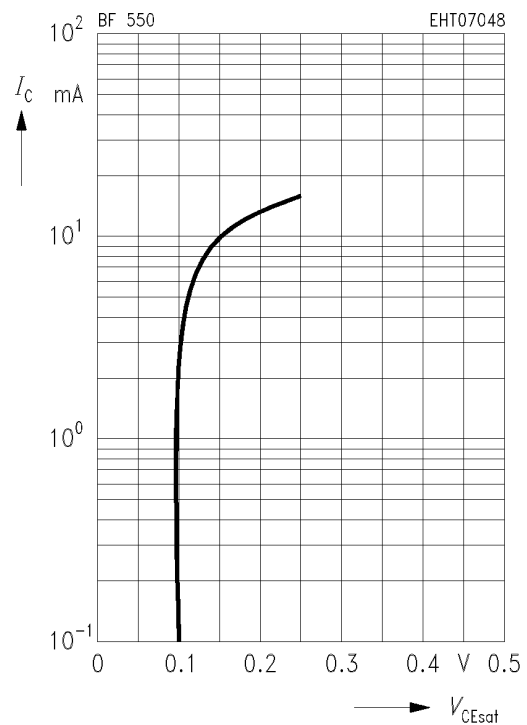

Collector cutoff current $I_{CB0} = f(T_A)$

$V_{CB} = 30\text{ V}$

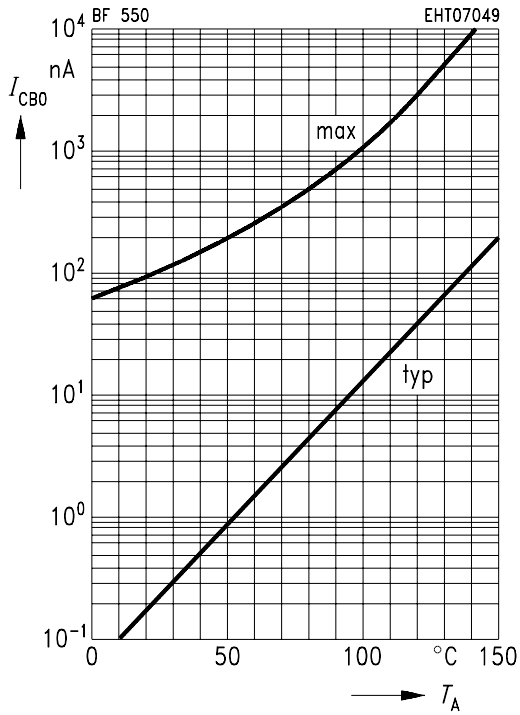

Transition frequency $f_T = f(I_C)$

$f = 100\text{ MHz}$

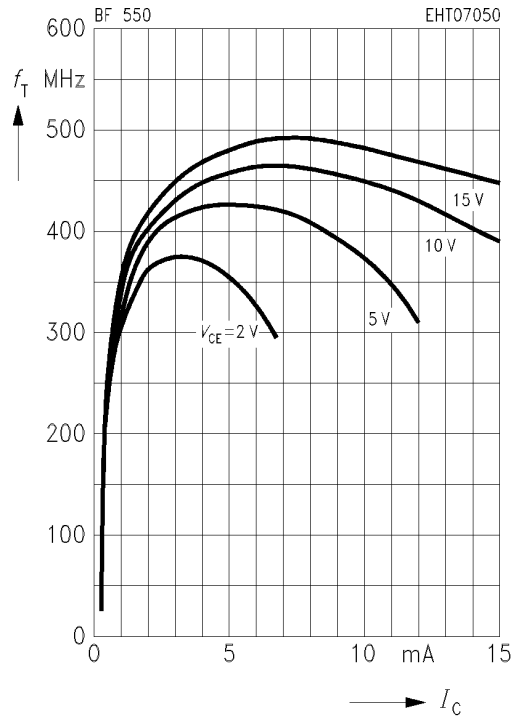

Collector-base capacitance $C_{cb} = f(V_{CB})$

$f = 1\text{ MHz}$

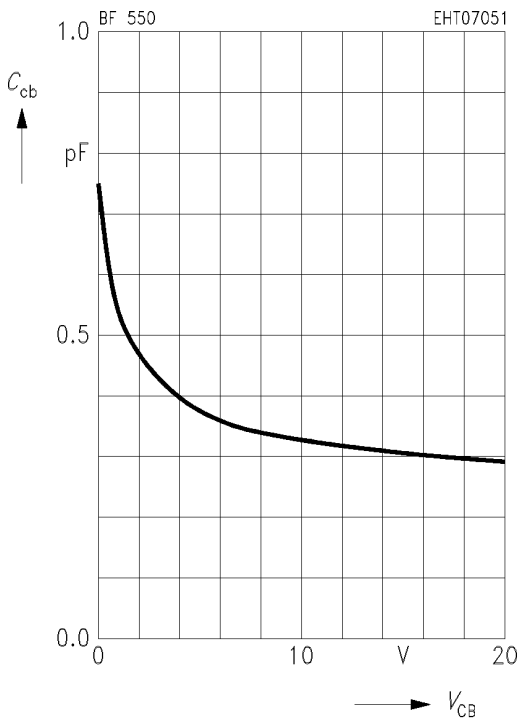

Output conductance $g_{22e} = f(I_C)$

$V_{CE} = 10\text{ V}, f = 500\text{ kHz}$

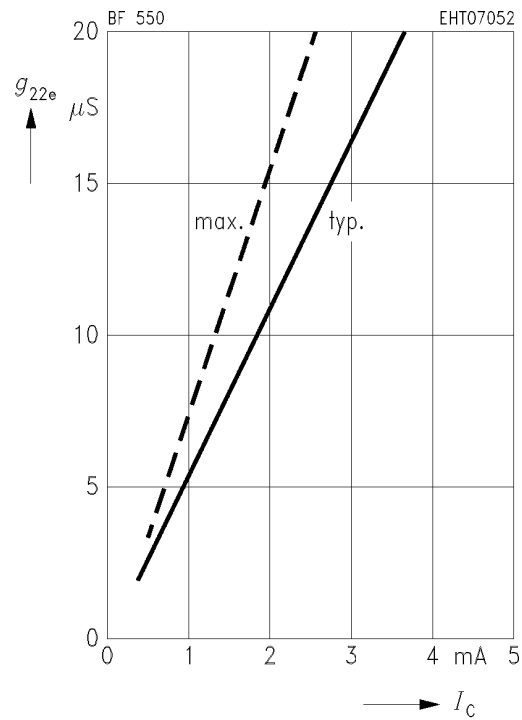

Forward transfer admittance $|y_{21e}| = f(I_C)$
 $f = 10.7 \text{ MHz}$

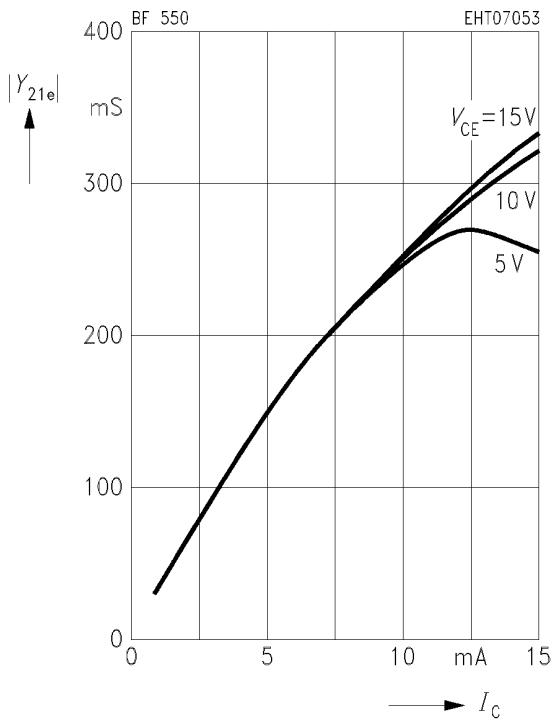

Forward transfer admittance y_{21e}
 $V_{CE} = 10 \text{ V}$

