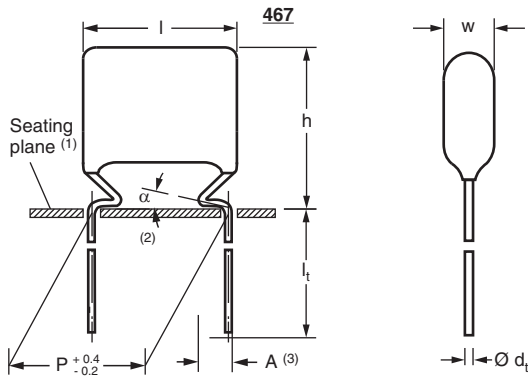
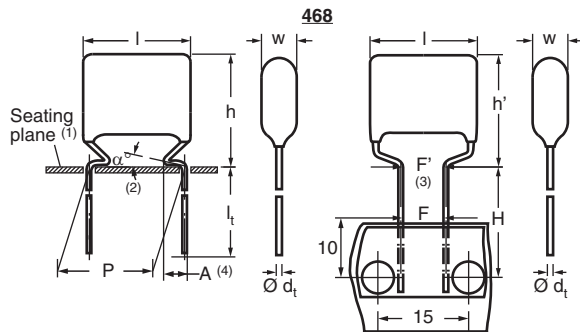

DC Film Capacitors MKT Radial Lacquered Type

Notes

- (1) Hole \varnothing 1.0 for $d_t = 0.6$ mm
 (2) $0 \leq \alpha < 50^\circ$
 (3) $A = 2.0 \pm 0.5$ mm

Notes

- (1) Hole \varnothing 1.0 for $d_t = 0.8$ mm
 (2) $0 \leq \alpha < 50^\circ$
 (3) $|F - F'| < 0.3$ mm
 $F = 7.5 + 0.6/-0.1$
 (4) $A = 2.5 + 1.4/-0.5 \pm 0.3$ mm

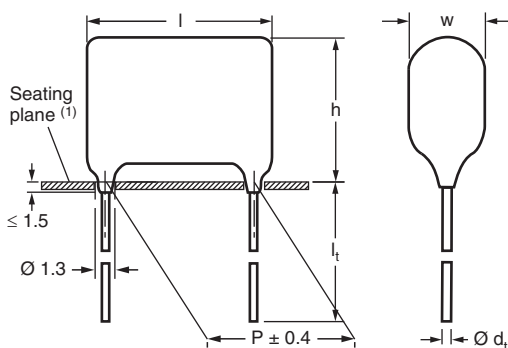
469 Straight Leads

Note

- (1) Hole \varnothing 1.0 for $d_t = 0.6$ mm

CONSTRUCTION

Mono construction

FEATURES

- AEC-Q200 qualified
- Available taped and loose in box
- Compliant to RoHS Directive 2002/95/EC

APPLICATIONS

Blocking and coupling, bypass and energy reservoir.

REFERENCE STANDARDS

IEC 60384-2

MARKING

C-value; tolerance; rated voltage; code for manufacturer; manufacturer's type; manufacturer's logo

DIELECTRIC

Polyester film

ELECTRODES

Metallized

RATED (DC) VOLTAGE

100 V, 250 V, 400 V, 630 V

RATED (AC) VOLTAGE

63 V, 160 V, 220 V, 250 V

ENCAPSULATION

Flame retardant epoxy material (UL-class 94 V-0)

CLIMATIC TESTING CLASS ACC. TO IEC 0068-1

55/105/56

RATED TEMPERATURE

85 °C

CAPACITANCE RANGE (E12 SERIES)
467: 0.001 μ F to 1.0 μ F

468: 0.039 μ F to 10.0 μ F

469: 0.001 μ F to 1.0 μ F

CAPACITANCE TOLERANCE
 $\pm 10\%$, $\pm 5\%$
LEADS

Tinned wire

MAXIMUM APPLICATION TEMPERATURE

105 °C

DETAIL SPECIFICATION

For more detailed data and test requirements contact:

dc-film@vishay.com

COMPOSITION OF CATALOG NUMBER: 467

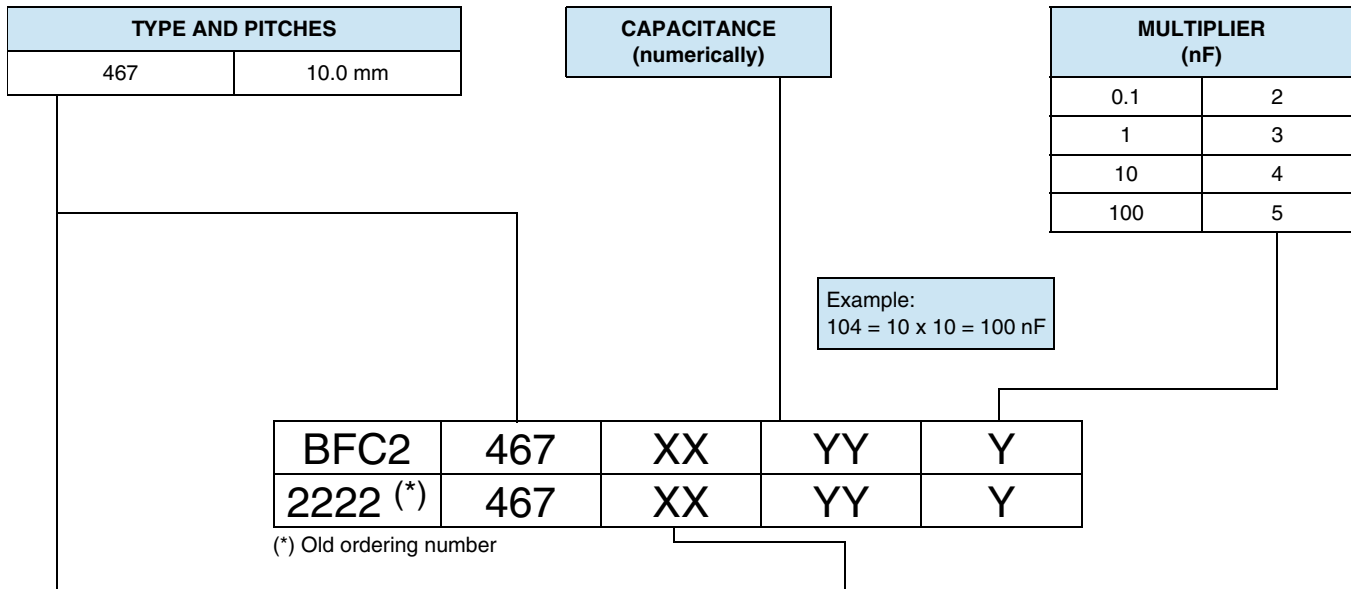

| TYPE | PACKAGING | LEAD CONFIGURATION | PREFERRED TYPES | | | | |
|------|-------------------|---------------------------------------|-----------------|-------|-------|-------|-------|
| | | | C-TOL. | 100 V | 250 V | 400 V | 630 V |
| 467 | Loose in box | Lead length | $\pm 10\%$ | 04 | 16 | 28 | 40 |
| | | 3.5 mm + 1.0 mm/- 0.5 mm | $\pm 5\%$ | 05 | 17 | 29 | 41 |
| | | Lead length | $\pm 10\%$ | 51 | 53 | 55 | 57 |
| | | 19.0 mm \pm 4.0 mm | $\pm 5\%$ | 52 | 54 | 56 | 58 |
| | Taped on reel (1) | H = 16.0 mm; P ₀ = 12.7 mm | $\pm 10\%$ | 06 | 18 | 30 | 42 |
| | | Reel diameter = 500 mm | $\pm 5\%$ | 07 | 19 | 31 | 43 |

Note

(1) For detailed tape specifications refer to packaging information: www.vishay.com/doc?28139

SPECIFIC REFERENCE DATA: 467

| DESCRIPTION | VALUE | | | |
|--|-------------------------|--------------------------|--------------------------|---------------------|
| Tangent of loss angle: C ≤ 0.1 μF 0.1 μF < C ≤ 0.47 μF 0.47 μF < C ≤ 1.0 μF | at 1 kHz | at 10 kHz | at 100 kHz | |
| | ≤ 75 x 10 ⁻⁴ | ≤ 120 x 10 ⁻⁴ | ≤ 200 x 10 ⁻⁴ | |
| | ≤ 75 x 10 ⁻⁴ | ≤ 120 x 10 ⁻⁴ | ≤ 225 x 10 ⁻⁴ | |
| Rated voltage pulse slope (dU/dt) _R at I _{max} = 12.5 mm | 100 V _{DC} | 250 V _{DC} | 400 V _{DC} | 630 V _{DC} |
| | 30 V/μs | 120 V/μs | 170 V/μs | 120 V/μs |
| R between leads, for C ≤ 0.33 μF at 100 V; 1 min at 500 V; 1 min | > 15 000 MΩ | > 30 000 MΩ | > 30 000 MΩ | > 30 000 MΩ |
| R between leads, for C > 0.33 μF at 100 V; 1 min at 500 V; 1 min | > 5000 s | > 10 000 s | > 10 000 s | > 10 000 s |
| R between interconnecting leads and casing, at 100 V; 1 min at 500 V; 1 min | > 30 000 MΩ | | | |
| Withstanding (DC) voltage (cut off current 10 mA) (1); rise time ≤ 1000 V/s | 160 V; 1 min | 400 V; 1 min | 640 V; 1 min | 1008 V; 1 min |
| Withstanding (DC) voltage between leads and case | 200 V; 1 min | 500 V; 1 min | 800 V; 1 min | 1260 V; 1 min |
| Maximum application temperature | 105 °C | | | |

Note

(1) See "Voltage Proof Test for Metallized Film Capacitors": www.vishay.com/doc?28169



U_{RDC} = 100 V; U_{RAC} = 63 V

| C (μF) | DIMENSIONS w _{max.} x h _{max.} x l _{max.} (mm) | MASS (g) ⁽¹⁾ | CATALOG NUMBER BFC2 467 XXYYY AND PACKAGING | | | | | | | C-VALUE ..YYY |
|--|---|----------------------------|--|-------------------|-----------------------------------|-------------------|--|-------------------|--------------------------|----------------------|
| | | | LOOSE IN BOX | | | | REEL | | C-tol. = ± 5 % | |
| | | | l _t = 3.5 mm + 1.0 mm/- 0.5 mm | | l _t = 19.0 mm ± 4.0 mm | | H = 16.0 mm; P ₀ = 12.7 mm | | | |
| | | | C-tol. = ± 10 % | C-tol. = ± 5 % | C-tol. = ± 10 % | C-tol. = ± 5 % | C-tol. = ± 10 % | C-tol. = ± 5 % | | |
| | | | XX (SPQ) | XX (SPQ) | XX (SPQ) | XX (SPQ) | XX (SPQ) | XX (SPQ) | | |
| Pitch = 10.0 mm ± 0.4 mm; d _t = 0.60 mm ± 0.06 mm | | | | | | | | | | |
| 0.056 0.068 0.082 0.1 | 4.0 x 14.0 x 12.5 | 0.37 | 04... (2000) | 05... (2000) | 51... (1500) | 52... (1500) | 06... (1500) | 07... (1500) | 563 683 823 104 | |
| 0.12 | 4.3 x 14.3 x 12.5 | 0.40 | 04... (2000) | 05... (2000) | 51... (1500) | 52... (1500) | 06... (1500) | 07... (1500) | 124 | |
| 0.15 | 4.0 x 14.0 x 12.5 | 0.37 | 04... (2000) | 05... (2000) | 51... (1500) | 52... (1500) | 06... (1500) | 07... (1500) | 154 | |
| 0.18 | 4.2 x 14.2 x 12.5 | 0.39 | 04... (2000) | 05... (2000) | 51... (1500) | 52... (1500) | 06... (1500) | 07... (1500) | 184 | |
| 0.22 | 4.5 x 14.6 x 12.5 | 0.43 | 04... (2000) | 05... (2000) | 51... (1500) | 52... (1500) | 06... (1300) | 07... (1300) | 224 | |
| 0.27 | 4.2 x 14.2 x 12.5 | 0.39 | 04... (2000) | 05... (2000) | 51... (1500) | 52... (1500) | 06... (1500) | 07... (1500) | 274 | |
| 0.33 | 4.6 x 14.6 x 12.5 | 0.44 | 04... (2000) | 05... (2000) | 51... (1500) | 52... (1500) | 06... (1300) | 07... (1300) | 334 | |
| 0.39 | 4.0 x 14.0 x 12.5 | 0.37 | 04... (2000) | 05... (2000) | 51... (1500) | 52... (1500) | 06... (1500) | 07... (1500) | 394 | |
| 0.47 | 4.2 x 14.2 x 12.5 | 0.39 | 04... (2000) | 05... (2000) | 51... (1500) | 52... (1500) | 06... (1500) | 07... (1500) | 474 | |
| 0.56 | 4.6 x 14.6 x 12.5 | 0.44 | 04... (2000) | 05... (2000) | 51... (1500) | 52... (1500) | 06... (1300) | 07... (1300) | 564 | |
| 0.68 | 5.0 x 15.0 x 12.5 | 0.50 | 04... (1500) | 05... (1500) | 51... (1250) | 52... (1250) | 06... (1200) | 07... (1200) | 684 | |
| 0.82 | 5.5 x 15.5 x 12.5 | 0.60 | 04... (1500) | 05... (1500) | 51... (1000) | 52... (1000) | 06... (1100) | 07... (1100) | 824 | |
| 1.0 | 6.0 x 16.0 x 12.5 | 0.75 | 04... (1250) | 05... (1250) | 51... (1000) | 52... (1000) | 06... (1000) | 07... (1000) | 105 | |

Notes

• SPQ = Standard Packing Quantity

⁽¹⁾ Net weight for short lead product only

$U_{RDC} = 250 \text{ V}$; $U_{RAC} = 160 \text{ V}$

| C (μF) | DIMENSIONS $w_{\text{max.}} \times h_{\text{max.}} \times l_{\text{max.}}$ (mm) | MASS (g) ⁽¹⁾ | CATALOG NUMBER BFC2 467 XXYYY AND PACKAGING | | | | | | |
|--|---|----------------------------|--|---------------------|--|---------------------|--|---------------------|---------|
| | | | LOOSE IN BOX | | | | REEL | | C-VALUE |
| | | | $l_t = 3.5 \text{ mm} + 1.0 \text{ mm} \pm 0.5 \text{ mm}$ | | $l_t = 19.0 \text{ mm} \pm 4.0 \text{ mm}$ | | $H = 16.0 \text{ mm}; P_0 = 12.7 \text{ mm}$ | | |
| | | | C-tol. = $\pm 10 \%$ | C-tol. = $\pm 5 \%$ | C-tol. = $\pm 10 \%$ | C-tol. = $\pm 5 \%$ | C-tol. = $\pm 10 \%$ | C-tol. = $\pm 5 \%$ | |
| | | | XX (SPQ) | XX (SPQ) | XX (SPQ) | XX (SPQ) | XX (SPQ) | XX (SPQ) | ..YYY |
| Pitch = 10.0 mm \pm 0.4 mm; $d_t = 0.60 \text{ m} \pm 0.06 \text{ mm}$ | | | | | | | | | |
| 0.027 | 4.2 x 14.2 x 12.5 | 0.39 | 16... (2000) | 17... (2000) | 53... (1500) | 54... (1500) | 18... (1500) | 19... (1500) | 273 |
| 0.033 | 4.6 x 14.6 x 12.5 | 0.44 | 16... (2000) | 17... (2000) | 53... (1500) | 54... (1500) | 18... (1300) | 19... (1300) | 333 |
| 0.039 | 4.0 x 14.0 x 12.5 | 0.37 | 16... (2000) | 17... (2000) | 53... (1500) | 54... (1500) | 18... (1500) | 19... (1500) | 393 |
| 0.047 | 4.1 x 14.1 x 12.5 | 0.38 | 16... (2000) | 17... (2000) | 53... (1500) | 54... (1500) | 18... (1500) | 19... (1500) | 473 |
| 0.056 | 4.0 x 14.0 x 12.5 | 0.37 | 16... (2000) | 17... (2000) | 53... (1500) | 54... (1500) | 18... (1500) | 19... (1500) | 563 |
| 0.068 | 4.1 x 14.1 x 12.5 | 0.38 | 16... (2000) | 17... (2000) | 53... (1500) | 54... (1500) | 18... (1500) | 19... (1500) | 683 |
| 0.082 | 4.4 x 14.4 x 12.5 | 0.41 | 16... (2000) | 17... (2000) | 53... (1500) | 54... (1500) | 18... (1500) | 19... (1500) | 823 |
| 0.1 | 4.0 x 14.0 x 12.5 | 0.37 | 16... (2000) | 17... (2000) | 53... (1500) | 54... (1500) | 18... (1500) | 19... (1500) | 104 |
| 0.12 | 4.3 x 14.3 x 12.5 | 0.40 | 16... (2000) | 17... (2000) | 53... (1500) | 54... (1500) | 18... (1500) | 19... (1500) | 124 |
| 0.15 | 4.8 x 14.8 x 12.5 | 0.48 | 16... (2000) | 17... (2000) | 53... (1250) | 54... (1250) | 18... (1300) | 19... (1300) | 154 |
| 0.18 | 5.2 x 15.2 x 12.5 | 0.52 | 16... (1500) | 17... (1500) | 53... (1000) | 54... (1000) | 18... (1200) | 19... (1200) | 184 |
| 0.22 | 5.8 x 15.8 x 12.5 | 0.67 | 16... (1500) | 17... (1500) | 53... (1000) | 54... (1000) | 18... (1100) | 19... (1100) | 224 |

Notes

- SPQ = Standard Packing Quantity
- ⁽¹⁾ Net weight for short lead product only



MKT467, MKT468, MKT469

DC Film Capacitors
MKT Radial Lacquered Type

Vishay BCcomponents

$U_{RDC} = 400\text{ V}$; $U_{RAC} = 220\text{ V}$

| C (μF) | DIMENSIONS $W_{max.} \times h_{max.} \times l_{max.}$ (mm) | MASS (g) ⁽¹⁾ | CATALOG NUMBER BFC2 467 XYYYY AND PACKAGING | | | | | | | C-VALUE ..YYY | |
|---|--|----------------------------|--|-----------------------|--|-----------------------|--|-----------------------|--------------------------|----------------------|-----------------------|
| | | | LOOSE IN BOX | | | | REEL | | C-tol. = $\pm 10\%$ | | C-tol. = $\pm 5\%$ |
| | | | $l_t = 3.5\text{ mm}$ $+ 1.0\text{ mm} / - 0.5\text{ mm}$ | | $l_t = 19.0\text{ mm} \pm 4.0\text{ mm}$ | | H = 16.0 mm; P ₀ = 12.7 mm | | | | |
| | | | C-tol. = $\pm 10\%$ | C-tol. = $\pm 5\%$ | C-tol. = $\pm 10\%$ | C-tol. = $\pm 5\%$ | C-tol. = $\pm 10\%$ | C-tol. = $\pm 5\%$ | | | |
| XX (SPQ) | XX (SPQ) | XX (SPQ) | XX (SPQ) | XX (SPQ) | XX (SPQ) | | | | | | |
| Pitch = 10.0 mm \pm 0.4 mm; $d_t = 0.60\text{ mm} \pm 0.06\text{ mm}$ | | | | | | | | | | | |
| 0.001 0.0012 0.0015 0.0018 | 4.5 x 14.5 x 12.5 | 0.43 | 28... (2000) | 29... (2000) | 55... (1500) | 56... (1500) | 30... (1300) | 31... (1300) | 102 122 152 182 | | |
| 0.0022 | 4.0 x 14.0 x 12.5 | 0.37 | 28... (2000) | 29... (2000) | 55... (1500) | 56... (1500) | 30... (1500) | 31... (1500) | 222 | | |
| 0.0027 | 4.3 x 14.3 x 12.5 | 0.40 | 28... (2000) | 29... (2000) | 55... (1500) | 56... (1500) | 30... (1500) | 31... (1500) | 272 | | |
| 0.0033 | 4.6 x 14.6 x 12.5 | 0.44 | 28... (2000) | 29... (2000) | 55... (1500) | 56... (1500) | 30... (1300) | 31... (1300) | 332 | | |
| 0.0039 | 4.0 x 14.0 x 12.5 | 0.37 | 28... (2000) | 29... (2000) | 55... (1500) | 56... (1500) | 30... (1500) | 31... (1500) | 393 | | |
| 0.0047 | 4.1 x 14.2 x 12.5 | 0.38 | 28... (2000) | 29... (2000) | 55... (1500) | 56... (1500) | 30... (1500) | 31... (1500) | 472 | | |
| 0.0056 | 4.6 x 14.6 x 12.5 | 0.44 | 28... (2000) | 29... (2000) | 55... (1500) | 56... (1500) | 30... (1300) | 31... (1300) | 562 | | |
| 0.0068 | 4.2 x 14.2 x 12.5 | 0.39 | 28... (2000) | 29... (2000) | 55... (1500) | 56... (1500) | 30... (1500) | 31... (1500) | 682 | | |
| 0.0082 | 4.6 x 14.6 x 12.5 | 0.44 | 28... (2000) | 29... (2000) | 55... (1500) | 56... (1500) | 30... (1300) | 31... (1300) | 822 | | |
| 0.01 | 4.1 x 14.1 x 12.5 | 0.38 | 28... (2000) | 29... (2000) | 55... (1500) | 56... (1500) | 30... (1500) | 31... (1500) | 103 | | |
| 0.012 | 4.5 x 14.5 x 12.5 | 0.43 | 28... (2000) | 29... (2000) | 55... (1500) | 56... (1500) | 30... (1300) | 31... (1300) | 123 | | |
| 0.015 | 4.1 x 14.1 x 12.5 | 0.38 | 28... (2000) | 29... (2000) | 55... (1500) | 56... (1500) | 30... (1500) | 31... (1500) | 153 | | |
| 0.018 | 4.5 x 14.5 x 12.5 | 0.43 | 28... (2000) | 29... (2000) | 55... (1500) | 56... (1500) | 30... (1300) | 31... (1300) | 183 | | |
| 0.022 | 4.0 x 14.0 x 12.5 | 0.37 | 28... (2000) | 29... (2000) | 55... (1500) | 56... (1500) | 30... (1500) | 31... (1500) | 223 | | |
| 0.027 | 4.2 x 14.2 x 12.5 | 0.39 | 28... (2000) | 29... (2000) | 55... (1500) | 56... (1500) | 30... (1500) | 31... (1500) | 273 | | |
| 0.033 | 4.6 x 14.7 x 12.5 | 0.44 | 28... (2000) | 29... (2000) | 55... (1500) | 56... (1500) | 30... (1300) | 31... (1300) | 333 | | |
| 0.039 | 5.0 x 14.9 x 12.5 | 0.50 | 28... (1500) | 29... (1500) | 55... (1250) | 56... (1250) | 30... (1200) | 31... (1200) | 393 | | |
| 0.047 | 4.1 x 14.1 x 12.5 | 0.38 | 28... (2000) | 29... (2000) | 55... (1500) | 56... (1500) | 30... (1500) | 31... (1500) | 473 | | |
| 0.056 | 4.4 x 14.4 x 12.5 | 0.41 | 28... (2000) | 29... (2000) | 55... (1500) | 56... (1500) | 30... (1500) | 31... (1500) | 563 | | |
| 0.068 | 4.8 x 14.8 x 12.5 | 0.48 | 28... (2000) | 29... (2000) | 55... (1250) | 56... (1250) | 30... (1300) | 31... (1300) | 683 | | |
| 0.082 | 5.4 x 15.3 x 12.5 | 0.57 | 28... (1500) | 29... (1500) | 55... (1000) | 56... (1000) | 30... (1200) | 31... (1200) | 823 | | |
| 0.1 | 5.7 x 15.7 x 12.5 | 0.64 | 28... (1500) | 29... (1500) | 55... (1000) | 56... (1000) | 30... (1100) | 31... (1100) | 104 | | |

Notes

- SPQ = Standard Packing Quantity
- ⁽¹⁾ Net weight for short lead product only

$U_{RDC} = 630\text{ V}$; $U_{RAC} = 250\text{ V}$

| C (μF) | DIMENSIONS $w_{\text{max.}} \times h_{\text{max.}} \times l_{\text{max.}}$ (mm) | MASS (g) ⁽¹⁾ | CATALOG NUMBER BFC2 467 XYYYY AND PACKAGING | | | | | | | C-VALUE ..YYY |
|--|---|----------------------------|--|-----------------------|--|-----------------------|---|-----------------------|-----------------------|----------------------|
| | | | LOOSE IN BOX | | | | REEL | | C-tol. = $\pm 5\%$ | |
| | | | $l_t = 3.5\text{ mm}$ $+ 1.0\text{ mm} \text{ /- } 0.5\text{ mm}$ | | $l_t = 19.0\text{ mm} \pm 4.0\text{ mm}$ | | $H = 16.0\text{ mm};$ $P_0 = 12.7\text{ mm}$ | | | |
| | | | C-tol. = $\pm 10\%$ | C-tol. = $\pm 5\%$ | C-tol. = $\pm 10\%$ | C-tol. = $\pm 5\%$ | C-tol. = $\pm 10\%$ | C-tol. = $\pm 5\%$ | | |
| XX (SPQ) | XX (SPQ) | XX (SPQ) | XX (SPQ) | XX (SPQ) | XX (SPQ) | | | | | |
| Pitch = 10.0 mm \pm 0.4 mm; $d_t = 0.60\text{ mm} \pm 0.06\text{ mm}$ | | | | | | | | | | |
| 0.01 | 4.1 x 14.1 x 12.5 | 0.38 | 40... (2000) | 41... (2000) | 57... (1500) | 58... (1500) | 42... (1500) | 43... (1500) | 103 | |
| 0.012 | 4.5 x 14.5 x 12.5 | 0.43 | 40... (2000) | 41... (2000) | 57... (1500) | 58... (1500) | 42... (1300) | 43... (1300) | 123 | |
| 0.015 | 4.9 x 14.9 x 12.5 | 0.49 | 40... (2000) | 41... (2000) | 57... (1250) | 58... (1250) | 42... (1200) | 43... (1200) | 153 | |
| 0.018 | 5.4 x 15.4 x 12.5 | 0.57 | 40... (1500) | 41... (1500) | 57... (1000) | 58... (1000) | 42... (1100) | 43... (1100) | 183 | |
| 0.022 | 4.8 x 14.8 x 12.5 | 0.48 | 40... (2000) | 41... (2000) | 57... (1250) | 58... (1250) | 42... (1300) | 43... (1300) | 223 | |
| 0.027 | 5.3 x 15.3 x 12.5 | 0.55 | 40... (2000) | 41... (2000) | 57... (1000) | 58... (1000) | 42... (1200) | 43... (1200) | 273 | |
| 0.033 | 5.9 x 15.9 x 12.5 | 0.70 | 40... (1500) | 41... (1500) | 57... (1000) | 58... (1000) | 42... (1100) | 43... (1100) | 333 | |

Notes

• SPQ = Standard Packing Quantity

⁽¹⁾ Net weight for short lead product only



COMPOSITION OF CATALOG NUMBER: 468

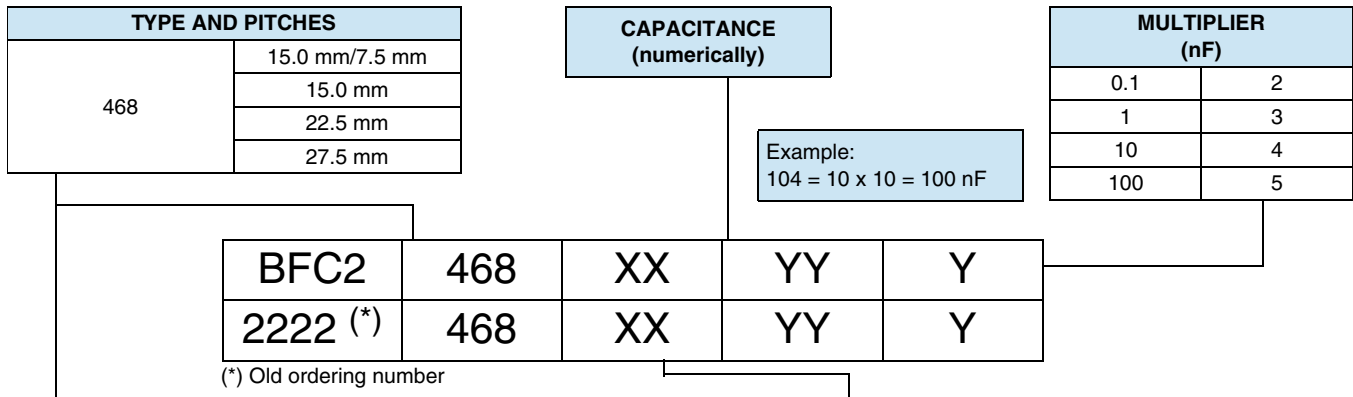

| TYPE | PACKAGING | LEAD CONFIGURATION | PREFERRED TYPES | | | | |
|-------|--|--|-----------------|-------|-------|-------|-------|
| | | | C-TOL. | 100 V | 250 V | 400 V | 630 V |
| 468 | Loose in box | Lead length 3.5 mm + 1.0 mm/- 0.5 mm (Pitch 10 mm and 15 mm) | ± 10 % | 04 | 16 | 28 | 40 |
| | | Lead length 3.5 mm ± 0.5 mm (Pitch 22.5 mm and 27.5 mm) | ± 5 % | 05 | 17 | 29 | 41 |
| | | Long leads: 19.0 mm ± 4.0 mm for lead pitch = 15.0 mm 25.0 mm ± 4.0 mm for lead pitch = 22.5 mm 24.0 mm ± 4.0 mm for lead pitch = 27.5 mm | ± 10 % | 51 | 53 | 55 | 57 |
| | | | ± 5 % | 52 | 54 | 56 | 58 |
| | Taped on reel (1) (bent back) | H = 16.0 mm; P ₀ = 15.0 mm Reel diameter = 500 mm (2) | ± 10 % | 61 | 63 | 65 | 67 |
| | | | ± 5 % | 62 | 64 | 66 | 68 |
| | Dimensions of these code numbers stay between brackets | | | | | | |
| | Taped on reel (1) | H = 16.0 mm; P ₀ = 12.7 mm Reel diameter = 500 mm | ± 10 % | 06 | 18 | 30 | 42 |
| ± 5 % | | | 07 | 19 | 31 | 43 | |

Notes

- (1) For detailed tape specifications refer to packaging information: www.vishay.com/doc?28139
- (2) Small reel diameter = 356 mm is available on request

SPECIFIC REFERENCE DATA: 468

| DESCRIPTION | VALUE | | | |
|---|-------------------------|--------------------------|--------------------------|---------------------|
| | at 1 kHz | at 10 kHz | at 100 kHz | |
| Tangent of loss angle: C ≤ 0.1 μF | ≤ 75 x 10 ⁻⁴ | ≤ 120 x 10 ⁻⁴ | ≤ 200 x 10 ⁻⁴ | |
| 0.1 μF < C ≤ 0.47 μF | ≤ 75 x 10 ⁻⁴ | ≤ 120 x 10 ⁻⁴ | ≤ 225 x 10 ⁻⁴ | |
| 0.47 μF < C ≤ 10 μF | ≤ 75 x 10 ⁻⁴ | ≤ 150 x 10 ⁻⁴ | - | |
| Rated voltage pulse slope (dU/dt) _R at | 100 V _{DC} | 250 V _{DC} | 400 V _{DC} | 630 V _{DC} |
| I _{max.} = 12.5 mm | 30 V/μs | 120 V/μs | 170 V/μs | 120 V/μs |
| I _{max.} = 17.5 mm | 20 V/μs | 45 V/μs | 65 V/μs | 90 V/μs |
| I _{max.} = 26.0 mm | 10 V/μs | 20 V/μs | 30 V/μs | 35 V/μs |
| I _{max.} = 30.0 mm | | 15 V/μs | 25 V/μs | 30 V/μs |
| R between leads, for C ≤ 0.33 μF at 100 V; 1 min at 500 V; 1 min | > 15 000 MΩ | > 30 000 MΩ | > 30 000 MΩ | > 30 000 MΩ |
| R between leads, for C > 0.33 μF at 100 V; 1 min at 500 V; 1 min | > 5000 s | > 10 000 s | > 10 000 s | > 10 000 s |
| R between interconnecting leads and casing, at 100 V; 1 min at 500 V; 1 min | > 30 000 MΩ | > 30 000 MΩ | > 30 000 MΩ | > 30 000 MΩ |
| Withstanding (DC) voltage (cut off current 10 mA) (1); rise time ≤ 1000 V/s | 160 V; 1 min | 400 V; 1 min | 640 V; 1 min | 1008 V; 1 min |
| Withstanding (DC) voltage between leads and case | 200 V; 1 min | 500 V; 1 min | 800 V; 1 min | 1260 V; 1 min |
| Maximum application temperature | 105 °C | | | |

Note

- (1) See "Voltage Proof Test for Metallized Film Capacitors": www.vishay.com/doc?28169

$U_{RDC} = 100\text{ V}$; $U_{RAC} = 63\text{ V}$

| C (μF) | DIMENSIONS $w_{\text{max.}} \times h \text{ (h')}_{\text{max.}} \times l_{\text{max.}}$ (mm) | MASS (g) ⁽¹⁾ | CATALOG NUMBER BFC2 467 XXYYY AND PACKAGING | | | | | | | | C-VALUE ..YYY |
|--|--|----------------------------|---|-----------------|--|-----------------|--|-----------------|---|----------------|----------------------|
| | | | LOOSE IN BOX | | | | REEL H = 16.0 mm | | | | |
| | | | C-tol. = $\pm 10\%$ | | C-tol. = $\pm 5\%$ | | Original pitch | | Bent back pitch | | |
| | | | XX (SPQ) | XX (SPQ) | XX (SPQ) | XX (SPQ) | XX (SPQ) | XX (SPQ) | XX (SPQ) | XX (SPQ) | |
| Pitch = 15.0 mm \pm 0.4 mm; $d_t = 0.80\text{ mm} \pm 0.08\text{ mm}$ | | | | | | | | | | | |
| | | | $l_t = 3.5\text{ mm} + 1.0\text{ mm}/- 0.5\text{ mm}$ | | $l_t = 19.0\text{ mm} \pm 4.0\text{ mm}$ | | $P = 15\text{ mm}$ $P_0 = 12.7\text{ mm}$ | | $P = 7.5\text{ mm}$ $P_0 = 15.0\text{ mm}$ | | |
| 1.2 | 5.5 x 14.5 (16.0) x 17.5 | 0.90 | 04... (2000) | 05... (2000) | 51... (1250) | 52... (1250) | 06... (1100) | 07... (1100) | 61... (900) | 62... (900) | 125 |
| 1.5 | 6.0 x 15.0 (16.5) x 17.5 | 1.00 | 04... (2000) | 05... (2000) | 51... (1250) | 52... (1250) | 06... (1000) | 07... (1000) | 61... (800) | 62... (800) | 155 |
| 1.8 | 6.5 x 15.5 (17.0) x 17.5 | 1.15 | 04... (1500) | 05... (1500) | 51... (1000) | 52... (1000) | 06... (900) | 07... (900) | 61... (750) | 62... (750) | 185 |
| 2.2 | 7.0 x 16.0 (17.5) x 17.5 | 1.25 | 04... (1250) | 05... (1250) | 51... (1000) | 52... (1000) | 06... (800) | 07... (800) | 61... (700) | 62... (700) | 225 |
| 2.7 | 8.0 x 17.0 (18.5) x 17.5 | 1.50 | 04... (1000) | 05... (1000) | 51... (1000) | 52... (1000) | 06... (750) | 07... (750) | 61... (600) | 62... (600) | 275 |
| 3.3 | 8.5 x 17.5 (19.0) x 17.5 | 1.70 | 04... (1000) | 05... (1000) | 51... (1000) | 52... (1000) | 06... (700) | 07... (700) | 61... (550) | 62... (550) | 335 |
| Pitch = 22.5 mm \pm 0.4 mm; $d_t = 0.80\text{ mm} \pm 0.08\text{ mm}$ | | | | | | | | | | | |
| | | | $l_t = 3.5\text{ mm} \pm 0.5\text{ mm}$ | | $l_t = 25.0\text{ mm} \pm 4.0\text{ mm}$ | | $P = 22.5\text{ mm}$ $P_0 = 12.7\text{ mm}$ | | $P = 7.5\text{ mm}$ $P_0 = 15.0\text{ mm}$ | | |
| 3.9 | 6.5 x 18.5 x 26.0 | 2.1 | 04... (1000) | 05... (1000) | 51... (750) | 52... (750) | 06... (650) | 07... (650) | | | 395 |
| 4.7 | 7.0 x 19.5 x 26.0 | 2.3 | 04... (900) | 05... (900) | 51... (700) | 52... (700) | 06... (550) | 07... (550) | | | 475 |
| 5.6 | 7.5 x 20.0 x 26.0 | 2.5 | 04... (750) | 05... (750) | 51... (600) | 52... (600) | 06... (500) | 07... (500) | | | 565 |
| 6.8 | 8.5 x 21.5 x 26.0 | 3.2 | 04... (750) | 05... (750) | 51... (500) | 52... (500) | 06... (450) | 07... (450) | | | 685 |
| 8.2 | 9.5 x 22.5 x 26.0 | 3.4 | 04... (700) | 05... (700) | 51... (500) | 52... (500) | 06... (400) | 07... (400) | | | 825 |
| 10.0 | 10.5 x 23.5 x 26.0 | 3.8 | 04... (500) | 05... (500) | 51... (400) | 52... (400) | 06... (350) | 07... (350) | | | 106 |

Notes

- SPQ = Standard Packing Quantity
- (1) Net weight for short lead product only



U_{RDC} = 250 V; U_{RAC} = 160 V

| C (μF) | DIMENSIONS W _{max.} x h (h') _{max.} x l _{max.} (mm) | MASS (g) ⁽¹⁾ | CATALOG NUMBER BFC2 468 XXYYY AND PACKAGING | | | | | | | | C-VALUE ..YYY |
|--|--|----------------------------|--|-------------------|--------------------------------------|-------------------|---|-------------------|--|-------------------|----------------------|
| | | | LOOSE IN BOX | | | | REEL H = 16.0 mm | | | | |
| | | | Original pitch | | Bent back pitch | | Original pitch | | Bent back pitch | | |
| | | | C-tol. = ± 10 % | C-tol. = ± 5 % | C-tol. = ± 10 % | C-tol. = ± 5 % | C-tol. = ± 10 % | C-tol. = ± 5 % | C-tol. = ± 10 % | C-tol. = ± 5 % | |
| | | | | XX (SPQ) | XX (SPQ) | XX (SPQ) | XX (SPQ) | XX (SPQ) | XX (SPQ) | | |
| Pitch = 15.0 mm ± 0.4 mm; d_t = 0.80 mm ± 0.08 mm | | | | | | | | | | | |
| | | | l _t = 3.5 mm + 1.0 mm/- 0.5 mm | | l _t = 19.0 mm ± 4.0 mm | | P = 15 mm P ₀ = 12.7 mm | | P = 7.5 mm P ₀ = 15.0 mm | | |
| 0.27 | 5.0 x 14.0 (15.5) x 17.5 | 0.80 | 16... (2000) | 17... (2000) | 53... (1250) | 54... (1250) | 18... (1200) | 19... (1200) | 63... (1000) | 64... (1000) | 274 |
| 0.33 | 5.5 x 14.5 (16.0) x 17.5 | 0.90 | 16... (2000) | 17... (2000) | 53... (1250) | 54... (1250) | 18... (1100) | 19... (1100) | 63... (900) | 64... (900) | 334 |
| 0.39 | 6.0 x 15.0 (16.5) x 17.5 | 1.00 | 16... (2000) | 17... (2000) | 53... (1250) | 54... (1250) | 18... (1000) | 19... (1000) | 63... (800) | 64... (800) | 394 |
| 0.47 | 6.5 x 15.5 (17.0) x 17.5 | 1.15 | 16... (1500) | 17... (1500) | 53... (1000) | 54... (1000) | 18... (900) | 19... (900) | 63... (750) | 64... (750) | 474 |
| 0.56 | 7.5 x 16.5 (18.0) x 17.5 | 1.30 | 16... (1250) | 17... (1250) | 53... (1000) | 54... (1000) | 18... (800) | 19... (800) | 63... (650) | 64... (650) | 564 |
| 0.68 | 8.0 x 17.0 (18.5) x 17.5 | 1.50 | 16... (1000) | 17... (1000) | 53... (1000) | 54... (1000) | 18... (750) | 19... (750) | 63... (600) | 64... (600) | 684 |
| 0.82 | 8.5 x 17.5 (19.0) x 17.5 | 1.70 | 16... (1000) | 17... (1000) | 53... (1000) | 54... (1000) | 18... (700) | 19... (700) | 63... (550) | 64... (550) | 824 |
| 1.0 | 8.0 x 20.0 (21.5) x 17.5 | 2.10 | 16... (1000) | 17... (1000) | 53... (900) | 54... (900) | 18... (750) | 19... (750) | 63... (600) | 64... (600) | 105 |
| Pitch = 22.5 mm ± 0.4 mm; d_t = 0.80 mm ± 0.08 mm | | | | | | | | | | | |
| | | | l _t = 3.5 mm ± 0.5 mm | | l _t = 25.0 mm ± 4.0 mm | | P = 22.5 mm P ₀ = 12.7 mm | | P = 7.5 mm P ₀ = 15.0 mm | | |
| 1.2 | 7.0 x 19.0 x 26.0 | 2.3 | 16... (1000) | 17... (1000) | 53... (700) | 54... (700) | 18... (550) | 19... (550) | | | 125 |
| 1.5 | 8.0 x 21.0 x 26.0 | 2.8 | 16... (750) | 17... (750) | 53... (500) | 54... (500) | 18... (500) | 19... (500) | | | 155 |
| 1.8 | 9.0 x 22.0 x 26.0 | 3.3 | 16... (750) | 17... (750) | 53... (500) | 54... (500) | 18... (450) | 19... (450) | | | 185 |
| 2.2 | 9.8 x 23.0 x 26.0 | 3.4 | 16... (750) | 17... (750) | 53... (450) | 54... (450) | 18... (400) | 19... (400) | | | 225 |
| 2.7 | 11.0 x 24.0 x 26.0 | 4.0 | 16... (500) | 17... (500) | 53... (400) | 54... (400) | 18... (350) | 19... (350) | | | 275 |
| 3.3 | 12.5 x 25.5 x 26.0 | 4.5 | 16... (500) | 17... (500) | 53... (300) | 54... (300) | 18... (350) | 19... (350) | | | 335 |
| 3.9 | 13.5 x 26.5 x 26.0 | 5.5 | 16... (400) | 17... (400) | 53... (300) | 54... (300) | 18... (300) | 19... (300) | | | 395 |
| 4.7 | 14.9 x 28.0 x 26.0 | 6.3 | 16... (250) | 17... (250) | 53... (250) | 54... (250) | 18... (250) | 19... (250) | | | 475 |
| Pitch = 27.5 mm ± 0.4 mm; d_t = 0.80 mm ± 0.08 mm; A = 2.5 mm + 1.4 mm/- 0.5 mm | | | | | | | | | | | |
| | | | l _t = 3.5 ± 0.5 mm | | l _t = 24.0 ± 4.0 mm | | P = 27.5 mm P ₀ = 12.7 mm | | P = 7.5 mm P ₀ = 15.0 mm | | |
| 5.6 | 15.0 x 28.0 x 30.0 | 7.5 | 16... (300) | 17... (300) | 53... (200) | 54... (200) | - | - | - | - | 565 |

Notes

• SPQ = Standard Packing Quantity

⁽¹⁾ Net weight for short lead product only

U_{RDC} = 400 V; U_{RAC} = 220 V

| C (μF) | DIMENSIONS W _{max.} x h (h') _{max.} x l _{max.} (mm) | MASS (g) ⁽¹⁾ | CATALOG NUMBER BFC2 468 XXYYY AND PACKAGING | | | | | | | | C-VALUE ..YYY | | |
|--|--|----------------------------|--|-----------------|--------------------------------------|-----------------|---|-----------------|--|-----------------|------------------|----------------|-----------------|
| | | | LOOSE IN BOX | | | | REEL H = 16.0 mm | | | | | | |
| | | | C-tol. = ± 10 % | | C-tol. = ± 5 % | | C-tol. = ± 10 % | | C-tol. = ± 5 % | | | Original pitch | Bent back pitch |
| | | | XX (SPQ) | XX (SPQ) | XX (SPQ) | XX (SPQ) | XX (SPQ) | XX (SPQ) | XX (SPQ) | XX (SPQ) | | XX (SPQ) | XX (SPQ) |
| Pitch = 15.0 mm ± 0.4 mm; d_t = 0.80 mm ± 0.08 mm | | | | | | | | | | | | | |
| | | | l _t = 3.5 mm + 1.0 mm/- 0.5 mm | | l _t = 19.0 mm ± 4.0 mm | | P = 15 mm P ₀ = 12.7 mm | | P = 7.5 mm P ₀ = 15.0 mm | | | | |
| 0.12 | 5.0 x 14.0 (15.5) x 17.5 | 0.80 | 28... (2000) | 29... (2000) | 55... (1250) | 56... (1250) | 30... (1200) | 31... (1200) | 65... (1000) | 66... (1000) | 124 | | |
| 0.15 | 5.8 x 15.0 (16.5) x 17.5 | 0.95 | 28... (1750) | 29... (1750) | 55... (1250) | 56... (1250) | 30... (1100) | 31... (1100) | 65... (850) | 66... (850) | 154 | | |
| 0.18 | 6.5 x 15.5 (17.0) x 17.5 | 1.15 | 28... (1500) | 29... (1500) | 55... (1000) | 56... (1000) | 30... (900) | 31... (900) | 65... (750) | 66... (750) | 184 | | |
| 0.22 | 7.0 x 16.0 (17.5) x 17.5 | 1.25 | 28... (1500) | 29... (1500) | 55... (1000) | 56... (1000) | 30... (800) | 31... (800) | 65... (700) | 66... (700) | 224 | | |
| 0.27 | 7.4 x 16.5 (18.0) x 17.5 | 1.28 | 28... (1250) | 29... (1250) | 55... (1250) | 56... (1250) | 30... (800) | 31... (800) | 65... (650) | 66... (650) | 274 | | |
| 0.33 | 8.5 x 17.5 (19.0) x 17.5 | 1.70 | 28... (1000) | 29... (1000) | 55... (1000) | 56... (1000) | 30... (700) | 31... (700) | 65... (550) | 66... (550) | 334 | | |
| 0.39 | 7.4 x 19.5 (21.0) x 17.5 | 2.00 | 28... (1000) | 29... (1000) | 55... (1000) | 56... (1000) | 30... (800) | 31... (800) | 65... (650) | 66... (650) | 394 | | |
| 0.47 | 8.4 x 20.5 (22.0) x 17.5 | 2.10 | 28... (750) | 29... (750) | 55... (850) | 56... (850) | 30... (700) | 31... (700) | 65... (550) | 66... (550) | 474 | | |
| Pitch = 22.5 mm ± 0.4 mm; d_t = 0.80 mm ± 0.08 mm | | | | | | | | | | | | | |
| | | | l _t = 3.5 mm ± 0.5 mm | | l _t = 25.0 mm ± 4.0 mm | | P = 22.5 mm P ₀ = 12.7 mm | | P = 7.5 mm P ₀ = 15.0 mm | | | | |
| 0.56 | 7.0 x 19.5 x 26.0 | 2.5 | 28... (1000) | 29... (1000) | 55... (650) | 56... (650) | 30... (550) | 28... (550) | | | 564 | | |
| 0.68 | 8.0 x 21.0 x 26.0 | 2.8 | 28... (750) | 29... (750) | 55... (500) | 56... (500) | 30... (500) | 28... (500) | | | 684 | | |
| 0.82 | 9.0 x 22.0 x 26.0 | 3.3 | 28... (750) | 29... (750) | 55... (500) | 56... (500) | 30... (450) | 28... (450) | | | 824 | | |
| 1.0 | 9.9 x 23.0 x 26.0 | 3.5 | 28... (750) | 29... (750) | 55... (450) | 56... (450) | 30... (400) | 28... (400) | | | 105 | | |
| 1.2 | 11.0 x 24.0 x 26.0 | 4.0 | 28... (500) | 29... (500) | 55... (400) | 56... (400) | 30... (350) | 28... (350) | | | 125 | | |
| Pitch = 27.5 mm ± 0.4 mm; d_t = 0.80 mm ± 0.08 mm; A = 2.5 mm + 1.4 mm/- 0.5 mm | | | | | | | | | | | | | |
| | | | l _t = 3.5 mm ± 0.5 mm | | l _t = 24.0 mm ± 4.0 mm | | P = 27.5 mm P ₀ = 12.7 mm | | P = 7.5 mm P ₀ = 15.0 mm | | | | |
| 1.5 | 11.5 x 24.5 x 30.0 | 5.8 | 28... (450) | 29... (450) | 55... (300) | 56... (300) | | | | | 155 | | |
| 1.8 | 12.5 x 25.5 x 30.0 | 6.4 | 28... (350) | 29... (350) | 55... (250) | 56... (250) | | | | | 185 | | |
| 2.2 | 14.0 x 27.0 x 30.0 | 7.3 | 28... (300) | 29... (300) | 55... (200) | 56... (200) | | | | | 225 | | |

Notes

• SPQ = Standard Packing Quantity

⁽¹⁾ Net weight for short lead product only



U_{RDC} = 630 V; U_{RAC} = 250 V

| C (µF) | DIMENSIONS W _{max.} x h (h') _{max.} x l _{max.} (mm) | MASS (g) ⁽¹⁾ | CATALOG NUMBER BFC2 468 XXYYY AND PACKAGING | | | | | | | | | |
|--|--|----------------------------|--|-------------------|--------------------------------------|-------------------|---|-------------------|--|-------------------|---------|--|
| | | | LOOSE IN BOX | | | | REEL H = 16.0 mm | | | | C-VALUE | |
| | | | Original pitch | | Bent back pitch | | | | | | | |
| | | | C-tol. = ± 10 % | C-tol. = ± 5 % | C-tol. = ± 10 % | C-tol. = ± 5 % | C-tol. = ± 10 % | C-tol. = ± 5 % | C-tol. = ± 10 % | C-tol. = ± 5 % | ..YYY | |
| XX (SPQ) | XX (SPQ) | XX (SPQ) | XX (SPQ) | XX (SPQ) | XX (SPQ) | XX (SPQ) | XX (SPQ) | XX (SPQ) | XX (SPQ) | | | |
| Pitch = 15.0 mm ± 0.4 mm; d_t = 0.80 mm ± 0.08 mm | | | | | | | | | | | | |
| | | | l _t = 3.5 mm + 1.0 mm/- 0.5 mm | | l _t = 19.0 mm ± 4.0 mm | | P = 15 mm P ₀ = 12.7 mm | | P = 7.5 mm P ₀ = 15.0 mm | | | |
| 0.039 | 5.0 x 14.0 (15.5) x 17.5 | 0.80 | 40... (2000) | 41... (2000) | 57... (1250) | 58... (1250) | 42... (1200) | 43... (1200) | 67... (1000) | 68... (1000) | 393 | |
| 0.047 | 5.5 x 14.5 (16.0) x 17.5 | 0.90 | 40... (2000) | 41... (2000) | 57... (1250) | 58... (1250) | 42... (1100) | 43... (1100) | 67... (900) | 68... (900) | 473 | |
| 0.056 | 5.9 x 15.0 (16.5) x 17.5 | 0.95 | 40... (1750) | 41... (1750) | 57... (1250) | 58... (1250) | 42... (1000) | 43... (1000) | 67... (850) | 68... (850) | 563 | |
| 0.068 | 6.5 x 16.0 (17.5) x 17.5 | 1.15 | 40... (1500) | 41... (1500) | 57... (1000) | 58... (1000) | 42... (800) | 43... (800) | 67... (750) | 68... (750) | 683 | |
| 0.082 | 7.3 x 16.5 (18.0) x 17.5 | 1.27 | 40... (1500) | 41... (1500) | 57... (1000) | 58... (1000) | 42... (800) | 43... (800) | 67... (650) | 68... (650) | 823 | |
| 0.1 | 7.9 x 17.0 (18.5) x 17.5 | 1.48 | 40... (1250) | 41... (1250) | 57... (1000) | 58... (1000) | 42... (750) | 43... (750) | 67... (600) | 68... (600) | 104 | |
| 0.12 | 7.5 x 19.5 (21.0) x 17.5 | 2.00 | 40... (1250) | 41... (1250) | 57... (1000) | 58... (1000) | 42... (800) | 43... (800) | 67... (650) | 68... (650) | 124 | |
| 0.15 | 8.5 x 20.5 (22.0) x 17.5 | 2.20 | 40... (1000) | 41... (1000) | 57... (850) | 58... (850) | 42... (700) | 43... (700) | 67... (550) | 68... (550) | 154 | |
| Pitch = 22.5 mm ± 0.4 mm; d_t = 0.80 mm ± 0.08 mm | | | | | | | | | | | | |
| | | | l _t = 3.5 mm ± 0.5 mm | | l _t = 25.0 mm ± 4.0 mm | | P = 22.5 mm P ₀ = 12.7 mm | | P = 7.5 mm P ₀ = 15.0 mm | | | |
| 0.18 | 7.5 x 19.5 x 26.0 | 2.5 | 40... (1000) | 41... (1000) | 57... (650) | 58... (650) | 42... (550) | 43... (550) | | | 184 | |
| 0.22 | 8.0 x 21.0 x 26.0 | 2.8 | 40... (750) | 41... (750) | 57... (500) | 58... (500) | 42... (500) | 43... (500) | | | 224 | |
| 0.27 | 9.0 x 22.0 x 26.0 | 3.3 | 40... (750) | 41... (750) | 57... (500) | 58... (500) | 42... (450) | 43... (450) | | | 274 | |
| 0.33 | 10.0 x 23.0 x 26.0 | 3.5 | 40... (700) | 41... (700) | 57... (450) | 58... (450) | 42... (400) | 43... (400) | | | 334 | |
| 0.39 | 11.5 x 24.0 x 26.0 | 4.2 | 40... (600) | 41... (600) | 57... (400) | 58... (400) | 42... (350) | 43... (350) | | | 394 | |
| 0.47 | 12.5 x 25.5 x 26.0 | 4.5 | 40... (500) | 41... (500) | 57... (300) | 58... (300) | 42... (350) | 43... (350) | | | 474 | |
| 0.56 | 13.5 x 26.6 x 26.0 | 5.5 | 40... (450) | 41... (450) | 57... (300) | 58... (300) | 42... (300) | 43... (300) | | | 564 | |
| 0.68 | 15.0 x 28.0 x 26.0 | 6.5 | 40... (400) | 41... (400) | 57... (250) | 58... (250) | 42... (250) | 43... (250) | | | 684 | |
| Pitch = 27.5 mm ± 0.4 mm; d_t = 0.80 mm ± 0.08 mm; A = 2.5 mm + 1.4 mm/- 0.5 mm | | | | | | | | | | | | |
| | | | l _t = 3.5 mm ± 0.5 mm | | l _t = 24.0 mm ± 4.0 mm | | P = 27.5 mm P ₀ = 12.7 mm | | P = 7.5 mm P ₀ = 15.0 mm | | | |
| 0.82 | 15.0 x 28.0 x 30.0 | 7.5 | 40... (300) | 41... (300) | 57... (200) | 58... (200) | | | | | | |

Notes

• SPQ = Standard Packing Quantity

⁽¹⁾ Net weight for short lead product only

COMPOSITION OF CATALOG NUMBER: 469

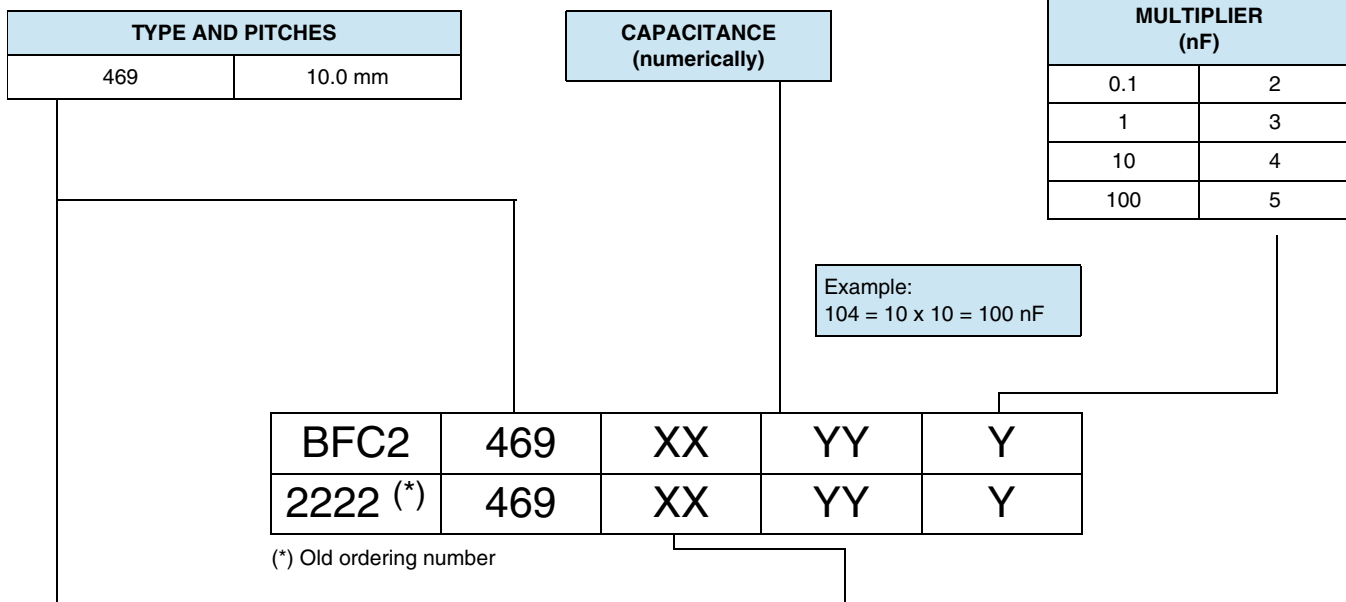

| TYPE | PACKAGING | LEAD CONFIGURATION | PREFERRED TYPES | | | | |
|------|-------------------|---|-----------------|-------|-------|-------|-------|
| | | | C-TOL. | 100 V | 250 V | 400 V | 630 V |
| 469 | Loose in box | Lead length 4.0 mm + 1.0 mm/- 0.5 mm | ± 10 % | 25 | 45 | 55 | 65 |
| | | | ± 5 % | 26 | 46 | 56 | 66 |
| | | Lead length 22.0 mm ± 4.0 mm | ± 10 % | 21 | 41 | 51 | 61 |
| | | | ± 5 % | 22 | 42 | 52 | 62 |
| | Taped on reel (1) | H = 18.5 mm; P ₀ = 12.7 mm Reel diameter = 500 mm | ± 10 % | 28 | 48 | 58 | 68 |
| | | | ± 5 % | 29 | 49 | 59 | 69 |

Note

(1) For detailed tape specifications refer to packaging information: www.vishay.com/doc?28139

SPECIFIC REFERENCE DATA: 469

| DESCRIPTION | VALUE | | | |
|---|-------------------------|--------------------------|--------------------------|---------------------|
| | at 1 kHz | at 10 kHz | at 100 kHz | |
| Tangent of loss angle: | | | | |
| C ≤ 0.1 μF | ≤ 75 x 10 ⁻⁴ | ≤ 120 x 10 ⁻⁴ | ≤ 200 x 10 ⁻⁴ | |
| 0.1 μF < C ≤ 0.47 μF | ≤ 75 x 10 ⁻⁴ | ≤ 120 x 10 ⁻⁴ | ≤ 225 x 10 ⁻⁴ | |
| 0.47 μF < C ≤ 1.0 μF | ≤ 75 x 10 ⁻⁴ | ≤ 120 x 10 ⁻⁴ | - | |
| Rated voltage pulse slope (dU/dt) _R at I _{max.} = 12.5 mm | 100 V _{DC} | 250 V _{DC} | 400 V _{DC} | 630 V _{DC} |
| | 30 V/μs | 120 V/μs | 170 V/μs | 120 V/μs |
| R between leads, for C ≤ 0.33 μF at 100 V; 1 min at 500 V; 1 min | > 15 000 MΩ | > 30 000 MΩ | > 30 000 MΩ | > 30 000 MΩ |
| R between leads, for C > 0.33 μF at 100 V; 1 min at 500 V; 1 min | > 5000 s | > 10 000 s | > 10 000 s | > 10 000 s |
| R between interconnecting leads and casing, at 100 V; 1 min at 500 V; 1 min | > 30 000 MΩ | > 30 000 MΩ | > 30 000 MΩ | > 30 000 MΩ |
| Withstanding (DC) voltage (cut off current 10 mA) (1); rise time ≤ 1000 V/s | 160 V; 1 min | 400 V; 1 min | 640 V; 1 min | 1008 V; 1 min |
| Withstanding (DC) voltage between leads and case | 200 V; 1 min | 500 V; 1 min | 840 V; 1 min | 1260 V; 1 min |
| Maximum application temperature | 105 °C | | | |

Note

(1) See "Voltage Proof Test for Metallized Film Capacitors": www.vishay.com/doc?28169



U_{RDC} = 100 V; U_{RAC} = 63 V

| C (μ F) | DIMENSIONS $w_{max.} \times h_{max.} \times l_{max.}$ (mm) | MASS (g) ⁽¹⁾ | CATALOG NUMBER BFC2 469 XXYYY AND PACKAGING | | | | | | | C-VALUE ..YYY |
|---|--|----------------------------|--|-----------------------|--|-----------------------|---|-----------------------|--------------------------|----------------------|
| | | | LOOSE IN BOX | | | | REEL | | C-tol. = $\pm 5\%$ | |
| | | | $l_t = 4.0\text{ mm}$ $+ 1.0\text{ mm}/- 0.5\text{ mm}$ | | $l_t = 22.0\text{ mm} \pm 4.0\text{ mm}$ | | $H = 18.5\text{ mm};$ $P_0 = 12.7\text{ mm}$ | | | |
| | | | C-tol. = $\pm 10\%$ | C-tol. = $\pm 5\%$ | C-tol. = $\pm 10\%$ | C-tol. = $\pm 5\%$ | C-tol. = $\pm 10\%$ | C-tol. = $\pm 5\%$ | | |
| | | | XX (SPQ) | XX (SPQ) | XX (SPQ) | XX (SPQ) | XX (SPQ) | XX (SPQ) | | |
| Pitch = 10.0 mm \pm 0.4 mm; $d_t = 0.60\text{ mm} \pm 0.06\text{ mm}$ | | | | | | | | | | |
| 0.056 0.068 0.082 0.1 | 4.0 x 11.0 x 12.5 | 0.35 | 25... (2000) | 26... (2000) | 21... (1500) | 22... (1500) | 28... (1500) | 29... (1500) | 563 683 823 104 | |
| 0.12 | 4.3 x 11.3 x 12.5 | 0.38 | 25... (2000) | 26... (2000) | 21... (1500) | 22... (1500) | 28... (1500) | 29... (1500) | 124 | |
| 0.15 | 3.9 x 10.9 x 12.5 | 0.34 | 25... (2000) | 26... (2000) | 21... (1500) | 22... (1500) | 28... (1500) | 29... (1500) | 154 | |
| 0.18 | 4.2 x 11.2 x 12.5 | 0.37 | 25... (2000) | 26... (2000) | 21... (1500) | 22... (1500) | 28... (1500) | 29... (1500) | 184 | |
| 0.22 | 4.5 x 11.5 x 12.5 | 0.40 | 25... (2000) | 26... (2000) | 21... (1500) | 22... (1500) | 28... (1300) | 29... (1300) | 224 | |
| 0.27 | 4.2 x 11.2 x 12.5 | 0.37 | 25... (2000) | 26... (2000) | 21... (1500) | 22... (1500) | 28... (1500) | 29... (1500) | 274 | |
| 0.33 | 4.6 x 11.6 x 12.5 | 0.41 | 25... (2000) | 26... (2000) | 21... (1500) | 22... (1500) | 28... (1300) | 29... (1300) | 334 | |
| 0.39 | 4.0 x 11.0 x 12.5 | 0.35 | 25... (2000) | 26... (2000) | 21... (1500) | 22... (1500) | 28... (1500) | 29... (1500) | 394 | |
| 0.47 | 4.2 x 11.2 x 12.5 | 0.37 | 25... (2000) | 26... (2000) | 21... (1500) | 22... (1500) | 28... (1500) | 29... (1500) | 474 | |
| 0.56 | 4.6 x 11.6 x 12.5 | 0.41 | 25... (2000) | 26... (2000) | 21... (1500) | 22... (1500) | 28... (1300) | 29... (1300) | 564 | |
| 0.68 | 5.0 x 12.0 x 12.5 | 0.44 | 25... (1500) | 26... (1500) | 21... (1250) | 22... (1250) | 28... (1200) | 29... (1200) | 684 | |
| 0.82 | 5.5 x 12.5 x 12.5 | 0.47 | 25... (1500) | 26... (1500) | 21... (1000) | 22... (1000) | 28... (1100) | 29... (1100) | 824 | |
| 1.0 | 6.0 x 13.0 x 12.5 | 0.55 | 25... (1250) | 26... (1250) | 21... (1000) | 22... (1000) | 28... (1000) | 29... (1000) | 105 | |

Notes

- SPQ = Standard Packing Quantity
- ⁽¹⁾ Net weight for short lead product only

$U_{RDC} = 250 \text{ V}$; $U_{RAC} = 160 \text{ V}$

| C (μF) | DIMENSIONS $w_{\text{max.}} \times h_{\text{max.}} \times l_{\text{max.}}$ (mm) | MASS (g) ⁽¹⁾ | CATALOG NUMBER BFC2 469 XYYYY AND PACKAGING | | | | | | | C-VALUE ..YYY |
|--|---|----------------------------|---|------------------------|--|------------------------|---|------------------------|------------------------|----------------------|
| | | | LOOSE IN BOX | | | | REEL | | C-tol. = $\pm 5 \%$ | |
| | | | $l_t = 4.0 \text{ mm}$ $+ 1.0 \text{ mm}/- 0.5 \text{ mm}$ | | $l_t = 22.0 \text{ mm} \pm 4.0 \text{ mm}$ | | $H = 18.5 \text{ mm};$ $P_0 = 12.7 \text{ mm}$ | | | |
| | | | C-tol. = $\pm 10 \%$ | C-tol. = $\pm 5 \%$ | C-tol. = $\pm 10 \%$ | C-tol. = $\pm 5 \%$ | C-tol. = $\pm 10 \%$ | C-tol. = $\pm 5 \%$ | | |
| XX (SPQ) | XX (SPQ) | XX (SPQ) | XX (SPQ) | XX (SPQ) | XX (SPQ) | | | | | |
| Pitch = 10.0 mm \pm 0.4 mm; $d_t = 0.60 \text{ mm} \pm 0.06 \text{ mm}$ | | | | | | | | | | |
| 0.027 | 4.2 x 11.2 x 12.5 | 0.37 | 45... (2000) | 46... (2000) | 41... (1500) | 42... (1500) | 48... (1500) | 49... (1500) | 273 | |
| 0.033 | 4.6 x 11.6 x 12.5 | 0.41 | 45... (2000) | 46... (2000) | 41... (1500) | 42... (1500) | 48... (1300) | 49... (1300) | 333 | |
| 0.039 | 4.0 x 11.0 x 12.5 | 0.35 | 45... (2000) | 46... (2000) | 41... (1500) | 42... (1500) | 48... (1500) | 49... (1500) | 393 | |
| 0.047 | 4.1 x 11.1 x 12.5 | 0.36 | 45... (2000) | 46... (2000) | 41... (1500) | 42... (1500) | 48... (1500) | 49... (1500) | 473 | |
| 0.056 | 4.0 x 11.0 x 12.5 | 0.35 | 45... (2000) | 46... (2000) | 41... (1500) | 42... (1500) | 48... (1500) | 49... (1500) | 563 | |
| 0.068 | 4.1 x 11.1 x 12.5 | 0.36 | 45... (2000) | 46... (2000) | 41... (1500) | 42... (1500) | 48... (1500) | 49... (1500) | 683 | |
| 0.082 | 4.4 x 11.4 x 12.5 | 0.39 | 45... (2000) | 46... (2000) | 41... (1500) | 42... (1500) | 48... (1500) | 49... (1500) | 823 | |
| 0.1 | 4.0 x 11.0 x 12.5 | 0.35 | 45... (2000) | 46... (2000) | 41... (1500) | 42... (1500) | 48... (1500) | 49... (1500) | 104 | |
| 0.12 | 4.3 x 11.3 x 12.5 | 0.38 | 45... (2000) | 46... (2000) | 41... (1500) | 42... (1500) | 48... (1500) | 49... (1500) | 124 | |
| 0.15 | 4.8 x 11.8 x 12.5 | 0.42 | 45... (2000) | 46... (2000) | 41... (1250) | 42... (1250) | 48... (1300) | 49... (1300) | 154 | |
| 0.18 | 5.2 x 12.2 x 12.5 | 0.45 | 45... (1500) | 46... (1500) | 41... (1000) | 42... (1000) | 48... (1200) | 49... (1200) | 184 | |
| 0.22 | 5.8 x 12.8 x 12.5 | 0.50 | 45... (1500) | 46... (1500) | 41... (1000) | 42... (1000) | 48... (1100) | 49... (1100) | 224 | |

Notes

• SPQ = Standard Packing Quantity

⁽¹⁾ Net weight for short lead product only



U_{RDC} = 400 V; U_{RAC} = 220 V

| C (μ F) | DIMENSIONS $w_{max.} \times h_{max.} \times l_{max.}$ (mm) | MASS (g) ⁽¹⁾ | CATALOG NUMBER BFC2 469 XXYYY AND PACKAGING | | | | | | | C-VALUE ..YYY |
|--|--|----------------------------|---|-----------------------|------------------------------|-----------------------|--|-----------------------|--------------------------|----------------------|
| | | | LOOSE IN BOX | | | | REEL | | | |
| | | | $l_t = 4.0$ mm + 1.0 mm/- 0.5 mm | | $l_t = 22.0$ mm \pm 4.0 mm | | H = 18.5 mm; P ₀ = 12.7 mm | | | |
| | | | C-tol. = \pm 10 % | C-tol. = \pm 5 % | C-tol. = \pm 10 % | C-tol. = \pm 5 % | C-tol. = \pm 10 % | C-tol. = \pm 5 % | | |
| XX (SPQ) | XX (SPQ) | XX (SPQ) | XX (SPQ) | XX (SPQ) | XX (SPQ) | XX (SPQ) | | | | |
| Pitch = 10.0 mm \pm 0.4 mm; d _t = 0.60 mm \pm 0.06 mm | | | | | | | | | | |
| 0.001 0.0012 0.0015 0.0018 | 4.5 x 11.5 x 12.5 | 0.40 | 55... (2000) | 56... (2000) | 51... (1500) | 52... (1500) | 58... (1300) | 59... (1300) | 102 122 152 182 | |
| 0.0022 | 4.0 x 11.0 x 12.5 | 0.35 | 55... (2000) | 56... (2000) | 51... (1500) | 52... (1500) | 58... (1500) | 59... (1500) | 222 | |
| 0.0027 | 4.3 x 11.3 x 12.5 | 0.38 | 55... (2000) | 56... (2000) | 51... (1500) | 52... (1500) | 58... (1500) | 59... (1500) | 272 | |
| 0.0033 | 4.6 x 11.6 x 12.5 | 0.41 | 55... (2000) | 56... (2000) | 51... (1500) | 52... (1500) | 58... (1300) | 59... (1300) | 332 | |
| 0.0039 | 4.0 x 11.0 x 12.5 | 0.35 | 55... (2000) | 56... (2000) | 51... (1500) | 52... (1500) | 58... (1500) | 59... (1500) | 392 | |
| 0.0047 | 4.1 x 11.1 x 12.5 | 0.36 | 55... (2000) | 56... (2000) | 51... (1500) | 52... (1500) | 58... (1500) | 59... (1500) | 472 | |
| 0.0056 | 4.6 x 11.6 x 12.5 | 0.41 | 55... (2000) | 56... (2000) | 51... (1500) | 52... (1500) | 58... (1300) | 59... (1300) | 562 | |
| 0.0068 | 4.2 x 11.2 x 12.5 | 0.37 | 55... (2000) | 56... (2000) | 51... (1500) | 52... (1500) | 58... (1500) | 59... (1500) | 682 | |
| 0.0082 | 4.6 x 11.6 x 12.5 | 0.41 | 55... (2000) | 56... (2000) | 51... (1500) | 52... (1500) | 58... (1300) | 59... (1300) | 822 | |
| 0.01 | 4.1 x 11.1 x 12.5 | 0.36 | 55... (2000) | 56... (2000) | 51... (1500) | 52... (1500) | 58... (1500) | 59... (1500) | 103 | |
| 0.012 | 4.5 x 11.5 x 12.5 | 0.40 | 55... (2000) | 56... (2000) | 51... (1500) | 52... (1500) | 58... (1300) | 59... (1300) | 123 | |
| 0.015 | 4.1 x 11.1 x 12.5 | 0.36 | 55... (2000) | 56... (2000) | 51... (1500) | 52... (1500) | 58... (1500) | 59... (1500) | 153 | |
| 0.018 | 4.5 x 11.5 x 12.5 | 0.40 | 55... (2000) | 56... (2000) | 51... (1500) | 52... (1500) | 58... (1300) | 59... (1300) | 183 | |
| 0.022 | 4.0 x 11.0 x 12.5 | 0.35 | 55... (2000) | 56... (2000) | 51... (1500) | 52... (1500) | 58... (1500) | 59... (1500) | 223 | |
| 0.027 | 4.2 x 11.2 x 12.5 | 0.37 | 55... (2000) | 56... (2000) | 51... (1500) | 52... (1500) | 58... (1500) | 59... (1500) | 273 | |
| 0.033 | 4.6 x 11.6 x 12.5 | 0.41 | 55... (2000) | 56... (2000) | 51... (1500) | 52... (1500) | 58... (1300) | 59... (1300) | 333 | |
| 0.039 | 5.0 x 12.0 x 12.5 | 0.44 | 55... (1500) | 56... (1500) | 51... (1250) | 52... (1250) | 58... (1200) | 59... (1200) | 393 | |
| 0.047 | 4.1 x 11.1 x 12.5 | 0.36 | 55... (2000) | 56... (2000) | 51... (1500) | 52... (1500) | 58... (1500) | 59... (1500) | 473 | |
| 0.056 | 4.4 x 11.4 x 12.5 | 0.39 | 55... (2000) | 56... (2000) | 51... (1500) | 52... (1500) | 58... (1500) | 59... (1500) | 563 | |
| 0.068 | 4.8 x 11.8 x 12.5 | 0.42 | 55... (2000) | 56... (2000) | 51... (1250) | 52... (1250) | 58... (1300) | 59... (1300) | 683 | |
| 0.082 | 5.4 x 12.4 x 12.5 | 0.46 | 55... (1500) | 56... (1500) | 51... (1000) | 52... (1000) | 58... (1200) | 59... (1200) | 823 | |
| 0.1 | 5.7 x 12.7 x 12.5 | 0.48 | 55... (1500) | 56... (1500) | 51... (1000) | 52... (1000) | 58... (1100) | 59... (1100) | 104 | |

Notes

- SPQ = Standard Packing Quantity
- ⁽¹⁾ Net weight for short lead product only

$U_{RDC} = 630 \text{ V}$; $U_{RAC} = 250 \text{ V}$

| C (μF) | DIMENSIONS $W_{\text{max.}} \times h_{\text{max.}} \times l_{\text{max.}}$ (mm) | MASS (g) ⁽¹⁾ | CATALOG NUMBER BFC2 469 XXYYY AND PACKAGING | | | | | | | C-VALUE |
|--|---|----------------------------|--|------------------------|--|------------------------|--|------------------------|-------|---------|
| | | | LOOSE IN BOX | | | | REEL | | ..YYY | |
| | | | $l_t = 4.0 \text{ mm} + 1.0 \text{ mm}/- 0.5 \text{ mm}$ | | $l_t = 22.0 \text{ mm} \pm 4.0 \text{ mm}$ | | H = 18.5 mm; P ₀ = 12.7 mm | | | |
| | | | C-tol. = $\pm 10 \%$ | C-tol. = $\pm 5 \%$ | C-tol. = $\pm 10 \%$ | C-tol. = $\pm 5 \%$ | C-tol. = $\pm 10 \%$ | C-tol. = $\pm 5 \%$ | | |
| XX (SPQ) | XX (SPQ) | XX (SPQ) | XX (SPQ) | XX (SPQ) | XX (SPQ) | XX (SPQ) | | | | |
| Pitch = 10.0 mm \pm 0.4 mm; $d_t = 0.60 \text{ mm} \pm 0.06 \text{ mm}$ | | | | | | | | | | |
| 0.01 | 4.1 x 11.1 x 12.5 | 0.36 | 65... (2000) | 66... (2000) | 61... (1500) | 62... (1500) | 68... (1500) | 69... (1500) | 103 | |
| 0.012 | 4.5 x 11.5 x 12.5 | 0.40 | 65... (2000) | 66... (2000) | 61... (1500) | 62... (1500) | 68... (1300) | 69... (1300) | 123 | |
| 0.015 | 4.9 x 11.9 x 12.5 | 0.43 | 65... (2000) | 66... (2000) | 61... (1250) | 62... (1250) | 68... (1200) | 69... (1200) | 153 | |
| 0.018 | 5.4 x 12.4 x 12.5 | 0.46 | 65... (1500) | 66... (1500) | 61... (1000) | 62... (1000) | 68... (1100) | 69... (1100) | 183 | |
| 0.022 | 4.8 x 11.8 x 12.5 | 0.42 | 65... (2000) | 66... (2000) | 61... (1250) | 62... (1250) | 68... (1300) | 69... (1300) | 223 | |
| 0.027 | 5.3 x 12.3 x 12.5 | 0.46 | 65... (2000) | 66... (2000) | 61... (1000) | 62... (1000) | 68... (1200) | 69... (1200) | 273 | |
| 0.033 | 5.9 x 12.9 x 12.5 | 0.52 | 65... (1500) | 66... (1500) | 61... (1000) | 62... (1000) | 68... (1100) | 69... (1100) | 333 | |

Notes

- SPQ = Standard Packing Quantity
- ⁽¹⁾ Net weight for short lead product only

MOUNTING

Normal Use

The capacitors are designed for mounting on printed-circuit boards. The capacitors packed in bandoliers are designed for mounting in printed-circuit boards by means of automatic insertion machines.

For detailed tape specifications refer to packaging information: www.vishay.com/doc?28139

Specific Method of Mounting to Withstand Vibration and Shock

In order to withstand vibration and shock tests, it must be ensured that the underside and the kinks are in good contact with the printed-circuit board.

- For pitches $\leq 15 \text{ mm}$ capacitors shall be mechanically fixed by the leads
- For larger pitches the capacitors shall be mounted in the same way and the body clamped

Storage Temperature

- Storage temperature: $T_{\text{stg}} = - 25 \text{ }^\circ\text{C}$ to $+ 40 \text{ }^\circ\text{C}$ with RH maximum 80 % without condensation

SOLDERING

For general soldering conditions and wave soldering profile, we refer to the application note:

“Soldering Guidelines for Film Capacitors”: www.vishay.com/doc?28171

Ratings and Characteristics Reference Conditions

Unless otherwise specified, all electrical values apply to an ambient free air temperature of $23 \text{ }^\circ\text{C} \pm 1 \text{ }^\circ\text{C}$, an atmospheric pressure of 86 kPa to 106 kPa and a relative humidity of $50 \text{ } \pm 2 \text{ } \%$.

For reference testing, a conditioning period shall be applied over $96 \text{ h} \pm 4 \text{ h}$ by heating the products in a circulating air oven at the rated temperature and a relative humidity not exceeding 20 %.



CHARACTERISTICS

Capacitance as a function of frequency (typical curve)

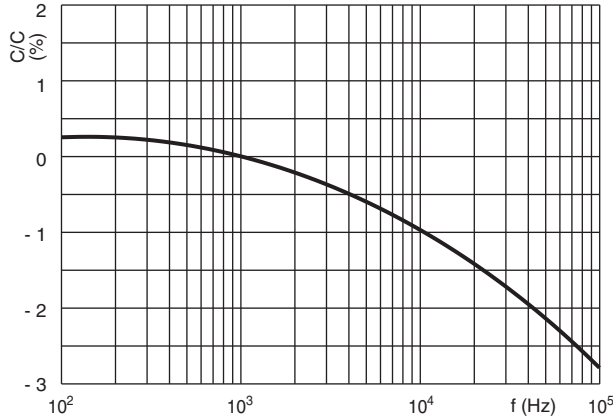

Capacitance as a function of ambient temperature (typical curve)

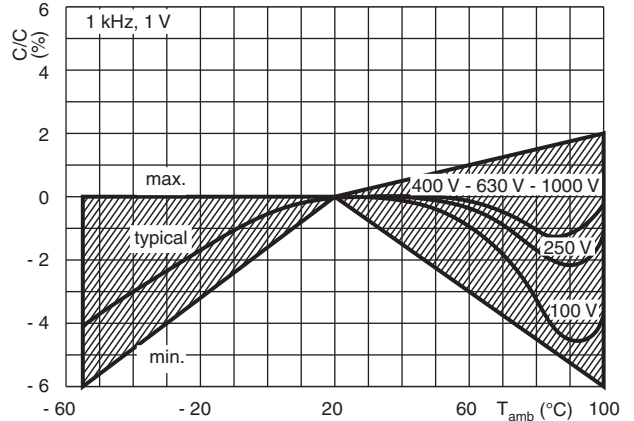

467, 469 - Impedance as a function of frequency (typical curve)

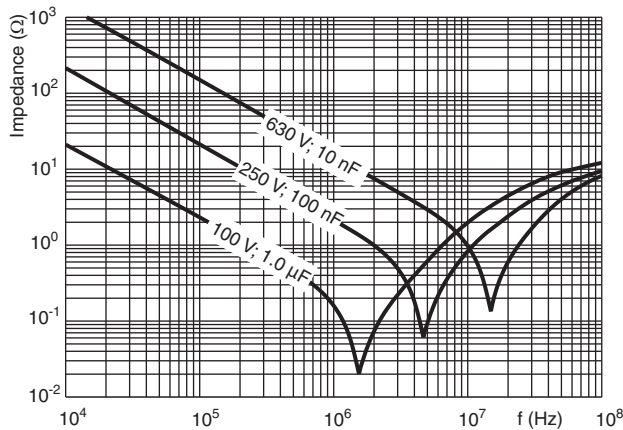

468 - Impedance as a function of frequency (typical curve)

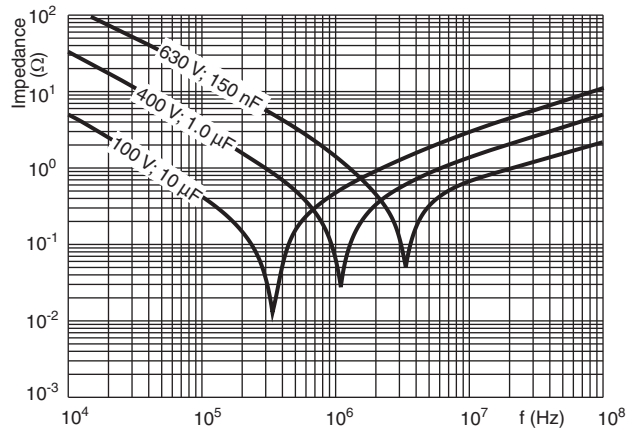

Max. DC and AC voltage as a function of temperature

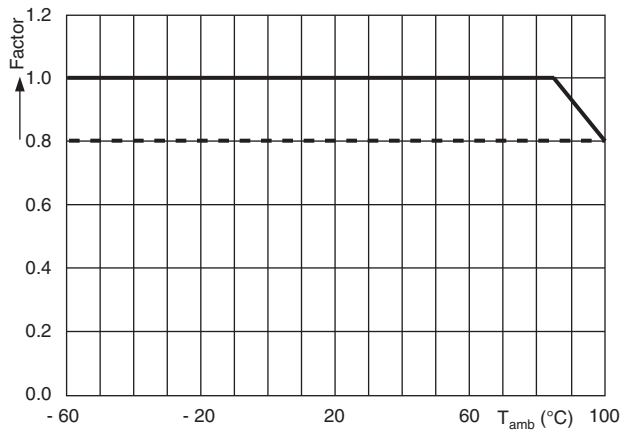

467, 469 - Max. RMS voltage as a function of frequency

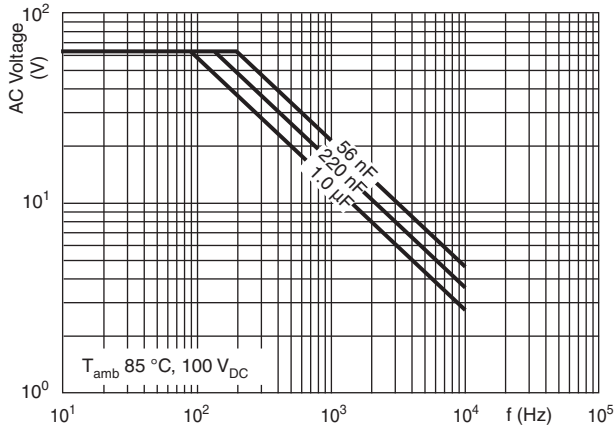

467, 469 - Max. RMS voltage as a function of frequency

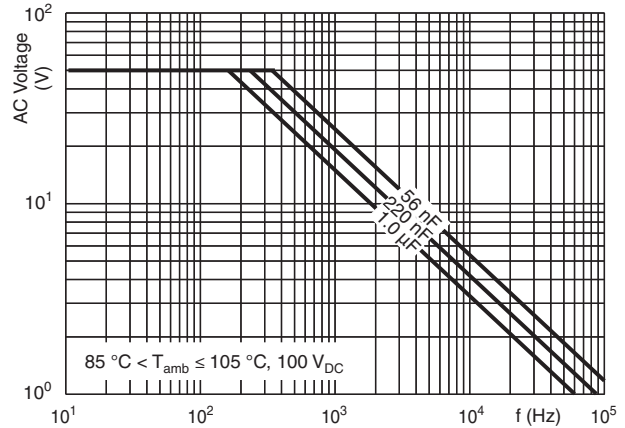

467, 469 - Max. RMS voltage as a function of frequency

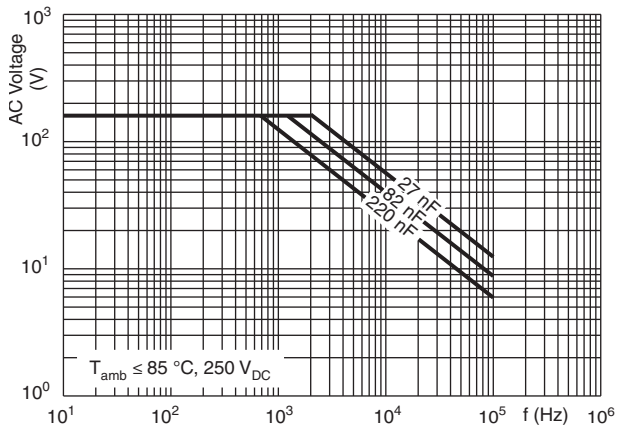

467, 469 - Max. RMS voltage as a function of frequency

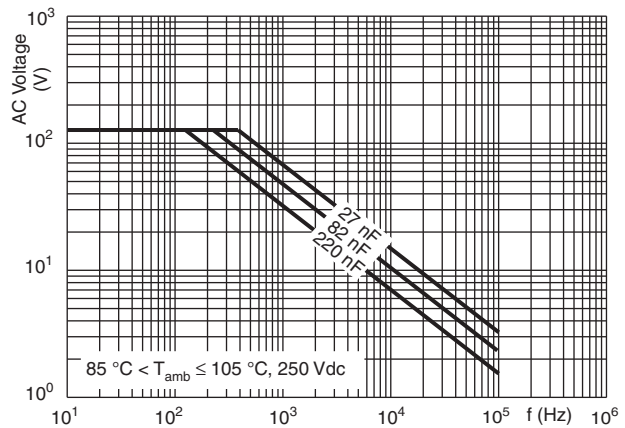

467, 469 - Max. RMS voltage as a function of frequency

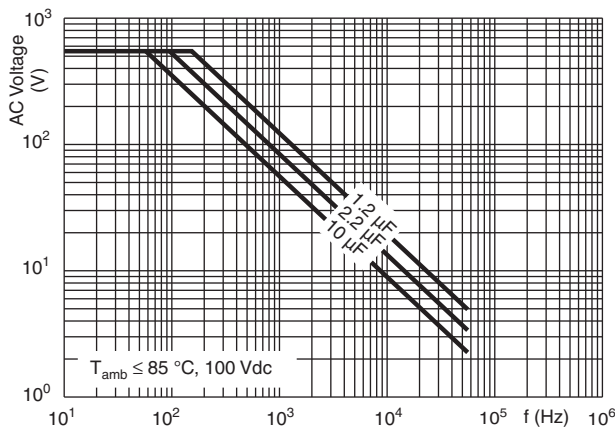

467, 469 - Max. RMS voltage as a function of frequency

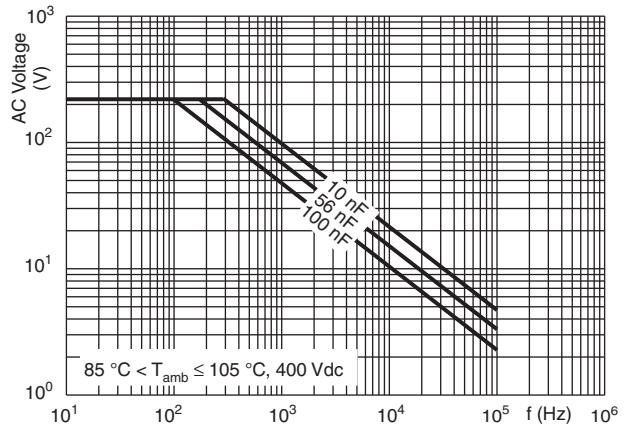



467, 469 - Max. RMS voltage as a function of frequency

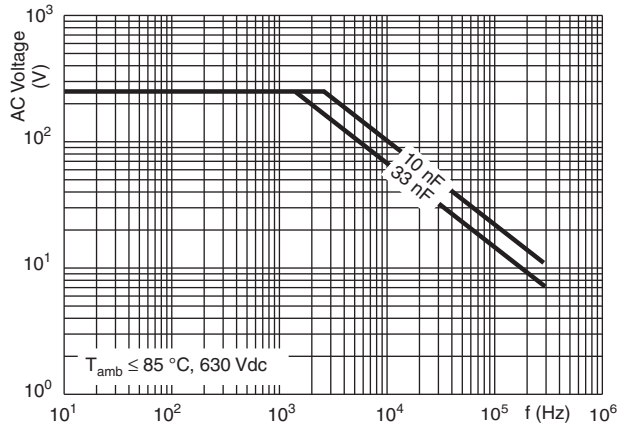

467, 469 - Max. RMS voltage as a function of frequency

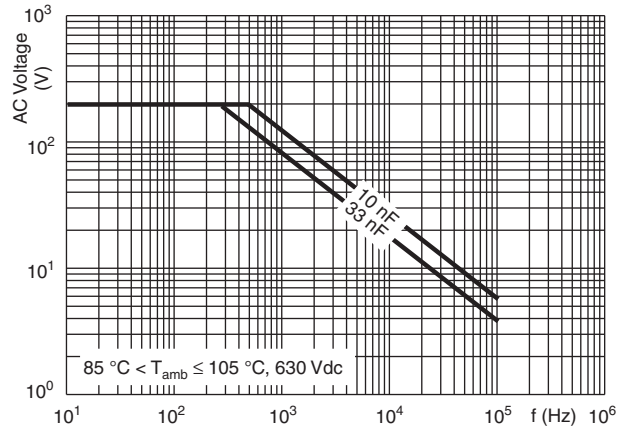

468 - Max. RMS voltage as a function of frequency

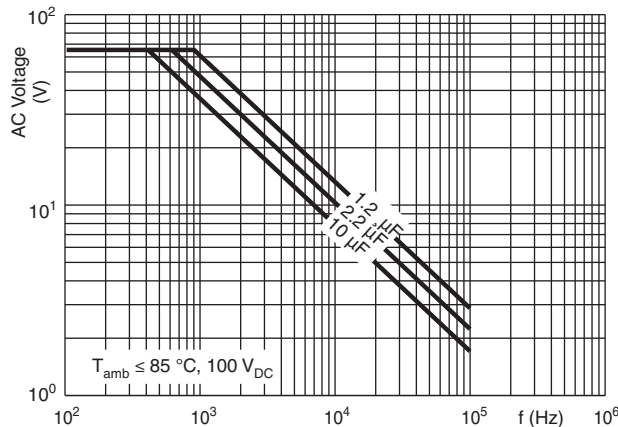

468 - Max. RMS voltage as a function of frequency

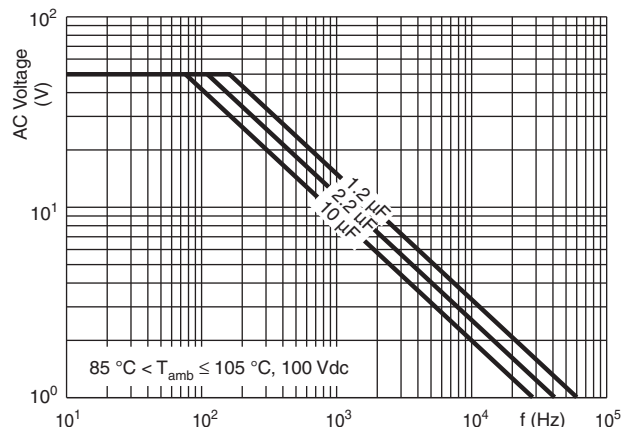

468 - Max. RMS voltage as a function of frequency

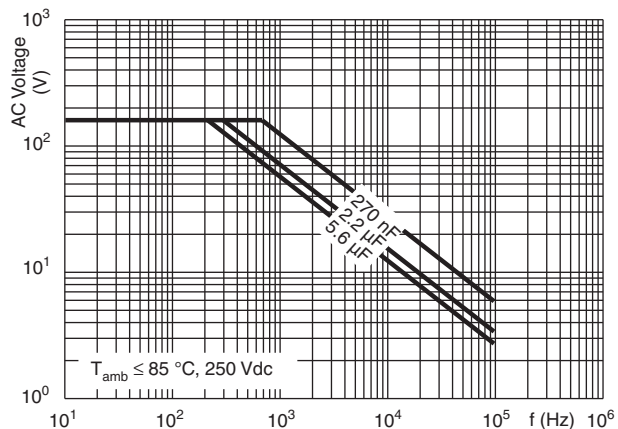

468 - Max. RMS voltage as a function of frequency

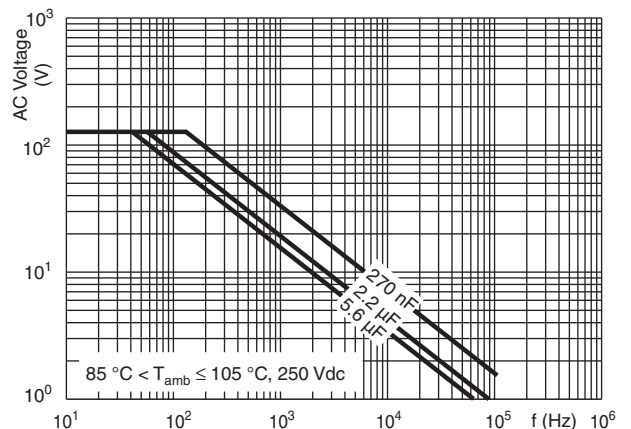

468 - Max. RMS voltage as a function of frequency

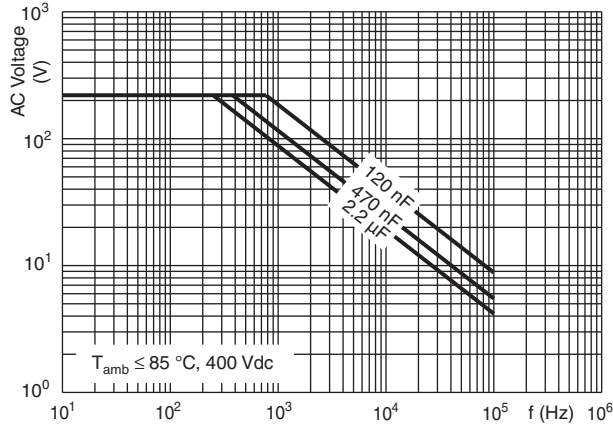

468 - Max. RMS voltage as a function of frequency

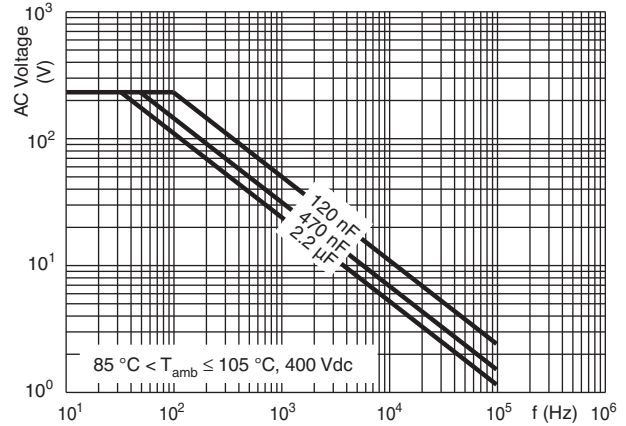

468 - Max. RMS voltage as a function of frequency

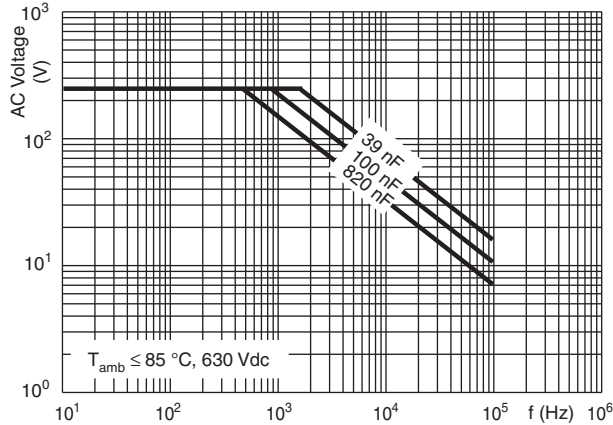

468 - Max. RMS voltage as a function of frequency

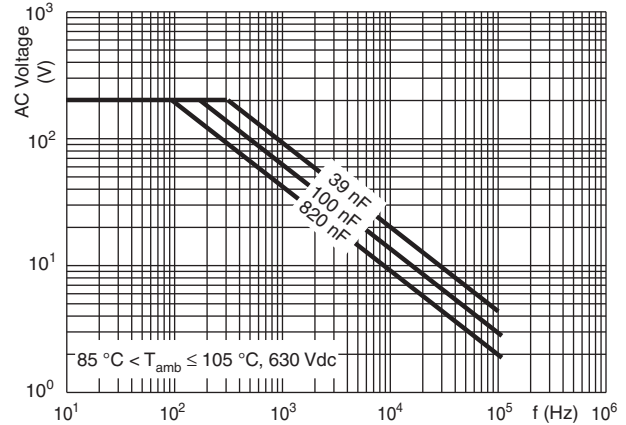

468 - Max. RMS voltage as a function of frequency

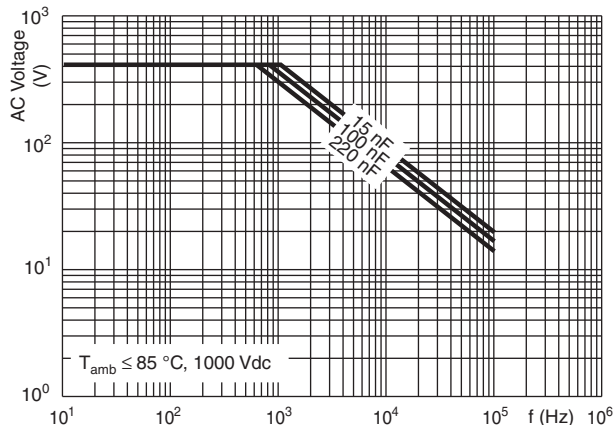

468 - Max. RMS voltage as a function of frequency

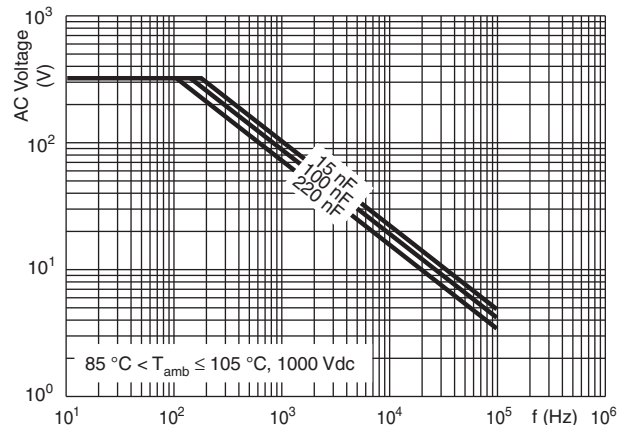



Tangent of loss angle as a function of frequency (typical curve)

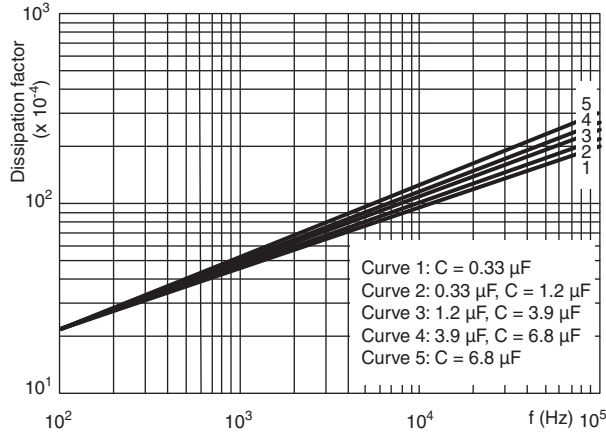

Insulation resistance as a function of the ambient temperature (typical curve)

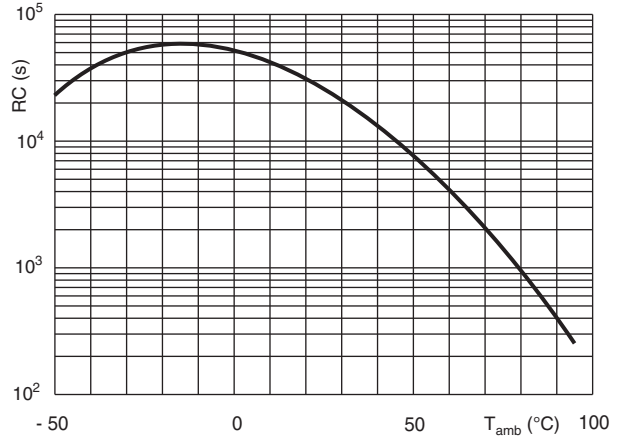

Maximum allowed component temperature rise (ΔT) as a function of the ambient temperature (T_{amb})

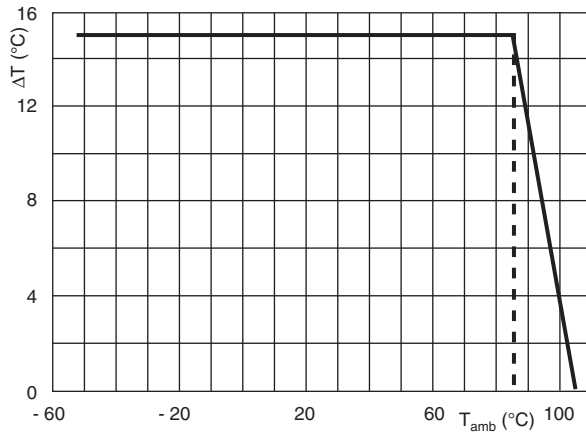

HEAT CONDUCTIVITY (G) AS A FUNCTION OF (ORIGINAL) PITCH AND CAPACITOR BODY THICKNESS IN mW/°C

| $W_{max.}$ (mm) | HEAT CONDUCTIVITY (mW/°C) | | | |
|--------------------|---------------------------|---------------|---------------|---------------|
| | PITCH 10 mm | PITCH 15.5 mm | PITCH 22.5 mm | PITCH 27.5 mm |
| 4.0 | 4.0 | 5.0 | - | - |
| 4.5 | 4.5 | 6.0 | - | - |
| 5.0 | 5.0 | 6.0 | 12.0 | 13.0 |
| 5.5 | 6.0 | 6.5 | 13.0 | 15.0 |
| 6.0 | 6.0 | 6.5 | 13.0 | 15.0 |
| 6.5 | 6.5 | 8.0 | 15.0 | 17.0 |
| 7.0 | - | 8.0 | 15.0 | 17.0 |
| 7.5 | - | 9.0 | 17.0 | 18.0 |
| 8.0 | - | 9.0 | 17.0 | 20.0 |
| 8.5 | - | 11.0 | 18.0 | 20.0 |
| 9.0 | - | 11.0 | 18.0 | 22.0 |
| 9.5 | - | 12.0 | 20.0 | 22.0 |
| 10.0 | - | 12.0 | 20.0 | 23.0 |
| 10.5 | - | - | 22.0 | 25.0 |
| 11.0 | - | - | - | 25.0 |
| 11.5 | - | - | - | 27.0 |

| W _{max.} (mm) | HEAT CONDUCTIVITY (mW/°C) | | | |
|---------------------------|---------------------------|---------------|---------------|---------------|
| | PITCH 10 mm | PITCH 15.5 mm | PITCH 22.5 mm | PITCH 27.5 mm |
| 12.0 | - | - | - | 27.0 |
| 12.5 | - | - | - | 30.0 |
| 13.0 | - | - | - | 30.0 |
| 13.5 | - | - | - | 30.0 |
| 14.0 | - | - | - | 30.0 |
| 14.5 | - | - | - | 33.0 |
| 15.0 | - | - | - | 33.0 |
| 15.5 | - | - | - | 37.0 |
| 16.0 | - | - | - | 37.0 |

POWER DISSIPATION AND MAXIMUM COMPONENT TEMPERATURE RISE

The power dissipation must be limited in order not to exceed the maximum allowed component temperature rise as a function of the free ambient temperature.

The power dissipation can be calculated according type detail specification "HQN-384-01/101: Technical Information Film Capacitors".

The component temperature rise (ΔT) can be measured (see section "Measuring the component temperature" for more details) or calculated by $\Delta T = P/G$:

- ΔT = Component temperature rise (°C)
- P = Power dissipation of the component (mW)
- G = Heat conductivity of the component (mW/°C)

MEASURING THE COMPONENT TEMPERATURE

A thermocouple must be attached to the capacitor body as in:

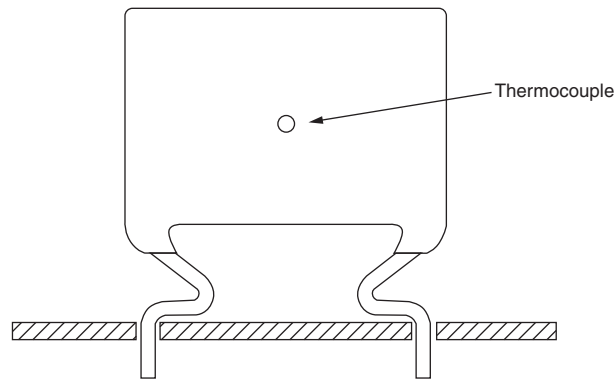

The temperature is measured in unloaded (T_{amb}) and maximum loaded condition (T_C).

The temperature rise is given by $\Delta T = T_C - T_{amb}$.

To avoid radiation or convection, the capacitor should be tested in a wind-free box.

APPLICATION NOTE AND LIMITING CONDITIONS

These capacitors are not suitable for mains applications as across-the-line capacitors without additional protection, as described hereunder. These mains applications are strictly regulated in safety standards and therefore electromagnetic interference suppression capacitors conforming the standards must be used.

For capacitors connected in parallel, normally the proof voltage and possibly the rated voltage must be reduced. For information depending of the capacitance value and the number of parallel connections contact: dc-film@vishay.com

To select the capacitor for a certain application, the following conditions must be checked:

1. The peak voltage (U_P) shall not be greater than the rated DC voltage (U_{RDC})
2. The peak-to-peak voltage (U_{P-P}) shall not be greater than $2\sqrt{2} \times U_{RAC}$ to avoid the ionisation inception level

3. The voltage pulse slope (dU/dt) shall not exceed the rated voltage pulse slope in an RC-circuit at rated voltage and without ringing. If the pulse voltage is lower than the rated DC voltage, the rated voltage pulse slope may be multiplied by U_{RDC} and divided by the applied voltage.

For all other pulses following equation must be fulfilled:

$$2 \times \int_0^T \left(\frac{dU}{dt} \right)^2 \times dt < U_{Rdc} \times \left(\frac{dU}{dt} \right)_{rated}$$

T is the pulse duration.

The rated voltage pulse slope is valid for ambient temperatures up to 85 °C. For higher temperatures a derating factor of 3 % per K shall be applied.

4. The maximum component surface temperature rise must be lower than the limits (see graph max. allowed component temperature rise).
5. Since in circuits used at voltages over 280 V peak-to-peak the risk for an intrinsically active flammability after a capacitor breakdown (short circuit) increases, it is recommended that the power to the component is limited to 100 times the values mentioned in the table: "Heat Conductivity"
6. When using these capacitors as across-the-line capacitor in the input filter for mains applications or as series connected with an impedance to the mains the applicant must guarantee that the following conditions are fulfilled in any case (spikes and surge voltages from the mains included).

Voltage Conditions for 6 Above

| ALLOWED VOLTAGES | $T_{amb} \leq 85 \text{ }^\circ\text{C}$ | $85 \text{ }^\circ\text{C} < T_{amb} \leq 105 \text{ }^\circ\text{C}$ |
|--|--|---|
| Maximum continuous RMS voltage | U_{RAC} | $0.8 \times U_{RAC}$ |
| Maximum temperature RMS-overvoltage (< 24 h) | $1.25 \times U_{RAC}$ | U_{RAC} |
| Maximum peak voltage (V_{O-P}) (< 2 s) | $1.6 \times U_{RAC}$ | $1.3 \times U_{RAC}$ |

EXAMPLE

C = 330 nF - 100 V used for the voltage signal shown in next drawing.

$U_{P-P} = 80 \text{ V}$; $U_P = 70 \text{ V}$; $T_1 = 0.5 \text{ ms}$; $T_2 = 1 \text{ ms}$

The ambient temperature is 35 °C

Checking conditions:

- The peak voltage $U_P = 70 \text{ V}$ is lower than $100 V_{DC}$
- The peak-to-peak voltage 80 V is lower than $2\sqrt{2} \times 63 V_{AC} = 178 U_{P-P}$
- The voltage pulse slope $(dU/dt) = 80 \text{ V}/500 \mu\text{s} = 0.16 \text{ V}/\mu\text{s}$
This is lower than $20 \text{ V}/\mu\text{s}$ (see specific reference data for each version)
- The dissipated power is 60 mW as calculated with fourier terms
The temperature rise for $W_{max.} = 8.5 \text{ mm}$ and pitch = 15 mm will be $60 \text{ mW}/11 \text{ mW}/^\circ\text{C} = 5.5 \text{ }^\circ\text{C}$
This is lower than 15 °C temperature rise at 35 °C, according figure "Max. allowed component temperature rise"
- Not applicable
- Not applicable

Voltage Signal

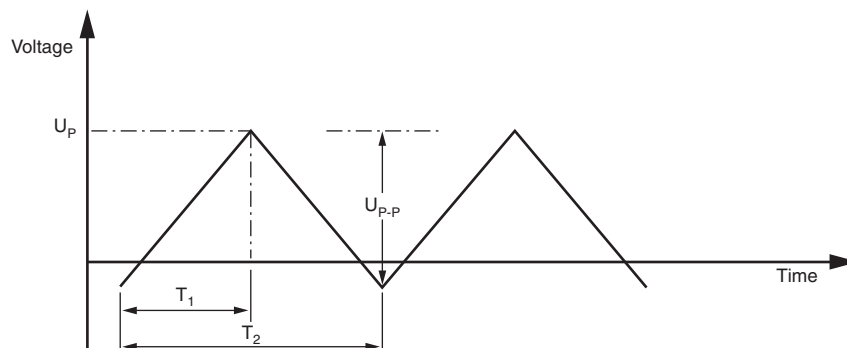

INSPECTION REQUIREMENTS

General Notes:

1. Sub-clause numbers of tests and performance requirements refer to the “Sectional Specification, Publication IEC 60384-2 and Specific Reference Data”.

Group C Inspection Requirements

| SUB-CLAUSE NUMBER AND TEST | CONDITIONS | PERFORMANCE REQUIREMENTS |
|---|---|---|
| SUB-GROUP C1A PART OF SAMPLE OF SUB-GROUP C1 | | |
| 4.1 Dimensions (detail) | | As specified in chapters “General Data” of this specification |
| 4.3.1 Initial measurements | Capacitance Tangent of loss angle: For C ≤ 470 nF at 100 kHz or for C > 470 nF at 10 kHz | |
| 4.3 Robustness of terminations | Tensile: Load 10 N; 10 s Bending: Load 5 N; 4 x 90° | No visible damage |
| 4.4 Resistance to soldering heat | Method: 1A Solder bath: 280 °C ± 5 °C Duration: 10 s | |
| 4.14 Component solvent resistance | Isopropylalcohol at room temperature Method: 2 Immersion time: 5 min ± 0.5 min Recovery time: Min. 1 h, max. 2 h | |
| 4.4.2 Final measurements | Visual examination Capacitance Tangent of loss angle | No visible damage Legible marking $ \Delta C/C \leq 2\%$ of the value measured initially Increase of tan δ ≤ 0.005 for: C ≤ 100 nF or ≤ 0.010 for: 100 nF < C ≤ 220 nF or ≤ 0.015 for: 220 nF < C ≤ 470 nF and ≤ 0.003 for: C > 470 nF Compared to values measured in 4.3.1 |
| SUB-GROUP C1B PART OF SAMPLE OF SUB-GROUP C1 | | |
| 4.6.1 Initial measurements | Capacitance Tangent of loss angle: For C ≤ 470 nF at 100 kHz or for C > 470 nF at 10 kHz | No visible damage |
| 4.6 Rapid change of temperature | θA = - 55 °C θB = + 100 °C 5 cycles Duration t = 30 min | |
| 4.7 Vibration | Visual examination Mounting: See section “Mounting” of this specification Procedure B4 Frequency range: 10 Hz to 55 Hz Amplitude: 0.75 mm or Acceleration 98 m/s ² (whichever is less severe) Total duration 6 h | No visible damage |
| 4.7.2 Final inspection | Visual examination | No visible damage |



| SUB-CLAUSE NUMBER AND TEST | CONDITIONS | PERFORMANCE REQUIREMENTS |
|--|--|--|
| 4.9 Shock 4.9.3 Final measurements | Mounting: See section "Mounting" of this specification Pulse shape: Half sine Acceleration: 490 m/s ² Duration of pulse: 11 ms Visual examination Capacitance Tangent of loss angle Insulation resistance | No visible damage $ \Delta C/C \leq 3\%$ of the value measured in 4.6.1 Increase of $\tan \delta$ ≤ 0.005 for: $C \leq 100$ nF or ≤ 0.010 for: 100 nF < $C \leq 220$ nF or ≤ 0.015 for: 220 nF < $C \leq 470$ nF and ≤ 0.003 for: $C > 470$ nF Compared to values measured in 4.6.1 As specified in section "Insulation Resistance" of this specification |
| SUB-GROUP C1 COMBINED SAMPLE OF SPECIMENS OF SUB-GROUPS C1A AND C1B | | |
| 4.10 Climatic sequence 4.10.2 Dry heat 4.10.3 Damp heat cyclic Test Db, first cycle 4.10.4 Cold 4.10.6 Damp heat cyclic Test Db, remaining cycles 4.10.6.2 Final measurements | Temperature: + 105 °C Duration: 16 h Temperature: - 55 °C Duration: 2 h Voltage proof = U_{RDC} for 1 min within 15 min after removal from test chamber Visual examination Capacitance Tangent of loss angle Insulation resistance | No breakdown of flash-over No visible damage Legible marking $ \Delta C/C \leq 5\%$ of the value measured in 4.4.2 or 4.9.3 Increase of $\tan \delta$ ≤ 0.007 for: $C \leq 100$ nF or ≤ 0.010 for: 100 nF < $C \leq 220$ nF or ≤ 0.015 for: 220 nF < $C \leq 470$ nF and ≤ 0.005 for: $C > 470$ nF Compared to values measured in 4.3.1 or 4.6.1 $\geq 50\%$ of values specified in section "Insulation Resistance" of this specification |
| SUB-GROUP C2 | | |
| 4.11 Damp heat steady state 4.11.1 Initial measurements 4.11.3 Final measurements | 56 days, 40 °C, 90 % to 95 % RH Capacitance Tangent of loss angle at 1 kHz Voltage proof = U_{RDC} for 1 min within 15 min after removal from test chamber Visual examination Capacitance Tangent of loss angle Insulation resistance | No breakdown of flash-over No visible damage Legible marking $ \Delta C/C \leq 5\%$ of the value measured in 4.11.1. Increase of $\tan \delta \leq 0.005$ Compared to values measured in 4.11.1 $\geq 50\%$ of values specified in section "Insulation Resistance" of this specification |
| SUB-GROUP C3 | | |
| 4.12 Endurance | Duration: 2000 h 1.25 x U_{RDC} at 85 °C 1.0 x U_{RDC} at 105 °C | |



| SUB-CLAUSE NUMBER AND TEST | CONDITIONS | PERFORMANCE REQUIREMENTS |
|---|--|--|
| 4.12.1 Initial measurements 4.12.5 Final measurements | Capacitance Tangent of loss angle: For C ≤ 470 nF at 100 kHz or for C > 470 nF at 10 kHz Visual examination Capacitance Tangent of loss angle Insulation resistance | No visible damage Legible marking $ \Delta C/C \leq 5\%$ compared to values measured in 4.12.1 Increase of tan δ ≤ 0.005 for: C ≤ 100 nF or ≤ 0.010 for: 100 nF < C ≤ 220 nF or ≤ 0.015 for: 220 nF < C ≤ 470 nF and ≤ 0.003 for: C > 470 nF Compared to values measured in 4.12.1 ≥ 50 % of values specified in section "Insulation Resistance" of this specification |
| SUB-GROUP C4 | | |
| 4.13 Charge and discharge 4.13.1 Initial measurements 4.13.3 Final measurements | 10 000 cycles Charged to U _{RDC} Discharge resistance: $R = \frac{U_R}{C \times 2.5 \times (dU/dt)_R}$ Capacitance Tangent of loss angle: For C ≤ 470 nF at 100 kHz or for C > 470 nF at 10 kHz Capacitance Tangent of loss angle Insulation resistance | $ \Delta C/C \leq 3\%$ compared to values measured in 4.13.1 Increase of tan δ ≤ 0.005 for: C ≤ 100 nF or ≤ 0.010 for: 100 nF < C ≤ 220 nF or ≤ 0.015 for: 220 nF < C ≤ 470 nF and ≤ 0.003 for: C > 470 nF Compared to values measured in 4.13.1 ≥ 50 % of values specified in section "Insulation Resistance" of this specification |



Disclaimer

ALL PRODUCT, PRODUCT SPECIFICATIONS AND DATA ARE SUBJECT TO CHANGE WITHOUT NOTICE TO IMPROVE RELIABILITY, FUNCTION OR DESIGN OR OTHERWISE.

Vishay Intertechnology, Inc., its affiliates, agents, and employees, and all persons acting on its or their behalf (collectively, "Vishay"), disclaim any and all liability for any errors, inaccuracies or incompleteness contained in any datasheet or in any other disclosure relating to any product.

Vishay makes no warranty, representation or guarantee regarding the suitability of the products for any particular purpose or the continuing production of any product. To the maximum extent permitted by applicable law, Vishay disclaims (i) any and all liability arising out of the application or use of any product, (ii) any and all liability, including without limitation special, consequential or incidental damages, and (iii) any and all implied warranties, including warranties of fitness for particular purpose, non-infringement and merchantability.

Statements regarding the suitability of products for certain types of applications are based on Vishay's knowledge of typical requirements that are often placed on Vishay products in generic applications. Such statements are not binding statements about the suitability of products for a particular application. It is the customer's responsibility to validate that a particular product with the properties described in the product specification is suitable for use in a particular application. Parameters provided in datasheets and/or specifications may vary in different applications and performance may vary over time. All operating parameters, including typical parameters, must be validated for each customer application by the customer's technical experts. Product specifications do not expand or otherwise modify Vishay's terms and conditions of purchase, including but not limited to the warranty expressed therein.

Except as expressly indicated in writing, Vishay products are not designed for use in medical, life-saving, or life-sustaining applications or for any other application in which the failure of the Vishay product could result in personal injury or death. Customers using or selling Vishay products not expressly indicated for use in such applications do so at their own risk. Please contact authorized Vishay personnel to obtain written terms and conditions regarding products designed for such applications.

No license, express or implied, by estoppel or otherwise, to any intellectual property rights is granted by this document or by any conduct of Vishay. Product names and markings noted herein may be trademarks of their respective owners.

Material Category Policy

Vishay Intertechnology, Inc. hereby certifies that all its products that are identified as RoHS-Compliant fulfill the definitions and restrictions defined under Directive 2011/65/EU of The European Parliament and of the Council of June 8, 2011 on the restriction of the use of certain hazardous substances in electrical and electronic equipment (EEE) - recast, unless otherwise specified as non-compliant.

Please note that some Vishay documentation may still make reference to RoHS Directive 2002/95/EC. We confirm that all the products identified as being compliant to Directive 2002/95/EC conform to Directive 2011/65/EU.

Vishay Intertechnology, Inc. hereby certifies that all its products that are identified as Halogen-Free follow Halogen-Free requirements as per JEDEC JS709A standards. Please note that some Vishay documentation may still make reference to the IEC 61249-2-21 definition. We confirm that all the products identified as being compliant to IEC 61249-2-21 conform to JEDEC JS709A standards.

Vishay:

[BFC246141003](#) [BFC246233902](#) [BFC246234302](#) [BFC246234702](#) [BFC246235102](#) [BFC246235602](#) [BFC246236202](#)
[BFC246236802](#) [BFC246237502](#) [BFC246238202](#) [BFC246239102](#) [BFC246241003](#) [BFC246241103](#) [BFC246241202](#)
[BFC246241203](#) [BFC246241302](#) [BFC246241303](#) [BFC246241502](#) [BFC246241503](#) [BFC246241602](#) [BFC246241603](#)
[BFC246241802](#) [BFC246241803](#) [BFC246242002](#) [BFC246242003](#) [BFC246242202](#) [BFC246242203](#) [BFC246242402](#)
[BFC246242702](#) [BFC246243002](#) [BFC246243302](#) [BFC246243602](#) [BFC246243902](#) [BFC246244302](#) [BFC246244702](#)
[BFC246245102](#) [BFC246245602](#) [BFC246246202](#) [BFC246247502](#) [BFC246248202](#) [BFC246249102](#) [BFC246261003](#)
[BFC246261103](#) [BFC246261202](#) [BFC246261203](#) [BFC246261302](#) [BFC246261303](#) [BFC246261502](#) [BFC246261503](#)
[BFC246261602](#) [BFC246261603](#) [BFC246261802](#) [BFC246261803](#) [BFC246262002](#) [BFC246262003](#) [BFC246262202](#)
[BFC246262203](#) [BFC246262402](#) [BFC246263002](#) [BFC246263302](#) [BFC246263602](#) [BFC246263902](#) [BFC246264302](#)
[BFC246264702](#) [BFC246265102](#) [BFC246265602](#) [BFC246266202](#) [BFC246266802](#) [BFC246267502](#) [BFC246268202](#)
[BFC246269102](#) [BFC246271003](#) [BFC246271103](#) [BFC246271202](#) [BFC246271203](#) [BFC246271302](#) [BFC246271303](#)
[BFC246271502](#) [BFC246271503](#) [BFC246271602](#) [BFC246271603](#) [BFC246271803](#) [BFC246272003](#) [BFC246272202](#)
[BFC246272402](#) [BFC246272492](#) [BFC246272702](#) [BFC246273002](#) [BFC246273302](#) [BFC246273602](#) [BFC246273902](#)
[BFC246274302](#) [BFC246274702](#) [BFC246275102](#) [BFC246275602](#) [BFC246276202](#) [BFC246276802](#) [BFC246277502](#)
[BFC246278202](#) [BFC246279102](#)