

## NPN Silicon High-Voltage Transistor

**BFN 22**

- Suitable for video output stages in TV sets and switching power supplies
- High breakdown voltage
- Low collector-emitter saturation voltage
- Low capacitance
- Complementary type: BFN 23 (PNP)

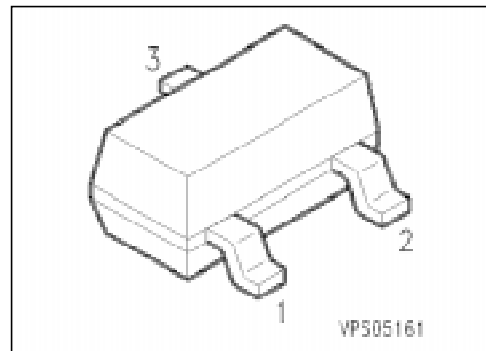

Type	Marking	Ordering Code (tape and reel)	Pin Configuration			Package <sup>1)</sup>
			1	2	3	
BFN 22	HBs	Q62702-F1024	B	E	C	SOT-23

### Maximum Ratings

Parameter	Symbol	Values	Unit
Collector-emitter voltage	$V_{CE0}$	250	V
Collector-base voltage	$V_{CB0}$	250	
Collector-emitter voltage, $R_{BE} = 2.7 \text{ k}\Omega$	$V_{CER}$	250	
Emitter-base voltage	$V_{EB0}$	5	
Collector current	$I_C$	50	mA
Peak collector current	$I_{CM}$	100	
Total power dissipation, $T_S = 71 \text{ }^\circ\text{C}$	$P_{tot}$	360	mW
Junction temperature	$T_j$	150	$^\circ\text{C}$
Storage temperature range	$T_{stg}$	- 65 ... + 150	

### Thermal Resistance

Junction - ambient <sup>2)</sup>	$R_{th \text{ JA}}$	$\leq 290$	K/W
Junction - soldering point	$R_{th \text{ JS}}$	$\leq 220$	

<sup>1)</sup> For detailed information see chapter Package Outlines.

<sup>2)</sup> Package mounted on epoxy pcb 40 mm × 40 mm × 1.5 mm/6 cm<sup>2</sup> Cu.

## Electrical Characteristics

at  $T_A = 25\text{ °C}$ , unless otherwise specified.

Parameter	Symbol	Values			Unit
		min.	typ.	max.	

### DC characteristics

Collector-emitter breakdown voltage $I_C = 1\text{ mA}$	$V_{(BR)CE0}$	250	–	–	V
Collector-base breakdown voltage $I_C = 10\text{ }\mu\text{A}$	$V_{(BR)CB0}$	250	–	–	
Collector-emitter breakdown voltage $I_C = 10\text{ }\mu\text{A}$ , $R_{BE} = 2.7\text{ k}\Omega$	$V_{(BR)CER}$	250	–	–	
Emitter-base breakdown voltage $I_E = 10\text{ }\mu\text{A}$	$V_{(BR)EB0}$	5	–	–	
Collector-base cutoff current $V_{CB} = 200\text{ V}$ $V_{CB} = 200\text{ V}$ , $T_A = 150\text{ °C}$	$I_{CB0}$	– –	– –	100 20	nA $\mu\text{A}$
Collector cutoff current $V_{CE} = 250\text{ V}$ , $R_{BE} = 2.7\text{ k}\Omega$ $V_{CE} = 250\text{ V}$ , $T_A = 150\text{ °C}$ , $R_{BE} = 2.7\text{ k}\Omega$	$I_{CER}$	– –	– –	1 50	$\mu\text{A}$
Emitter-base cutoff current $V_{EB} = 5\text{ V}$	$I_{EB0}$	–	–	10	
DC current gain <sup>1)</sup> $I_C = 25\text{ mA}$ , $V_{CE} = 20\text{ V}$	$h_{FE}$	50	–	–	–
Collector-emitter saturation voltage <sup>1)</sup> $I_C = 10\text{ mA}$ , $I_B = 1\text{ mA}$	$V_{CEsat}$	–	–	0.5	V
Base-emitter saturation voltage <sup>1)</sup> $I_C = 10\text{ mA}$ , $I_B = 1\text{ mA}$	$V_{BEsat}$	–	–	1	

### AC characteristics

Transition frequency $I_C = 10\text{ mA}$ , $V_{CE} = 10\text{ V}$ , $f = 20\text{ MHz}$	$f$	–	100	–	MHz
Output capacitance $V_{CB} = 30\text{ V}$ , $f = 1\text{ MHz}$	$C_{obo}$	–	0.8	–	pF

<sup>1)</sup> Pulse test conditions:  $t \leq 300\text{ }\mu\text{s}$ ,  $D = 2\text{ %}$ .

**Total power dissipation  $P_{tot} = f(T_A^*; T_S)$**

\* Package mounted on epoxy

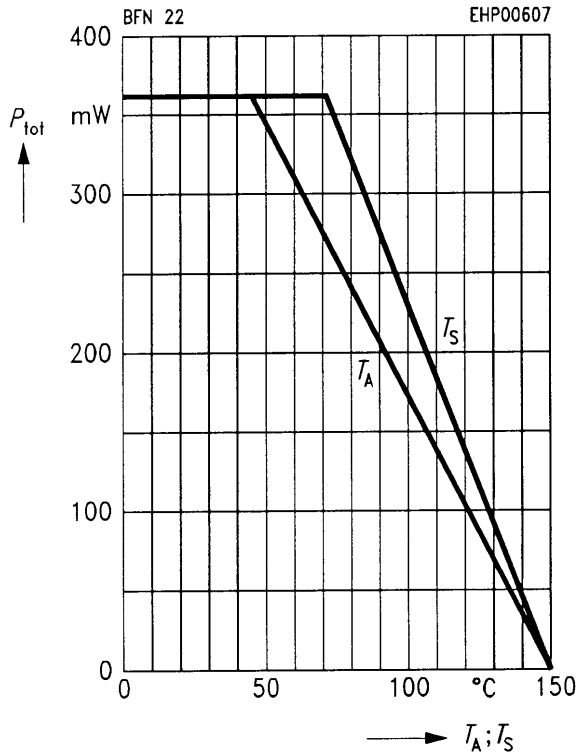

**Output capacitance  $C_{obo} = f(V_{CE})$**

$f = 1$  MHz

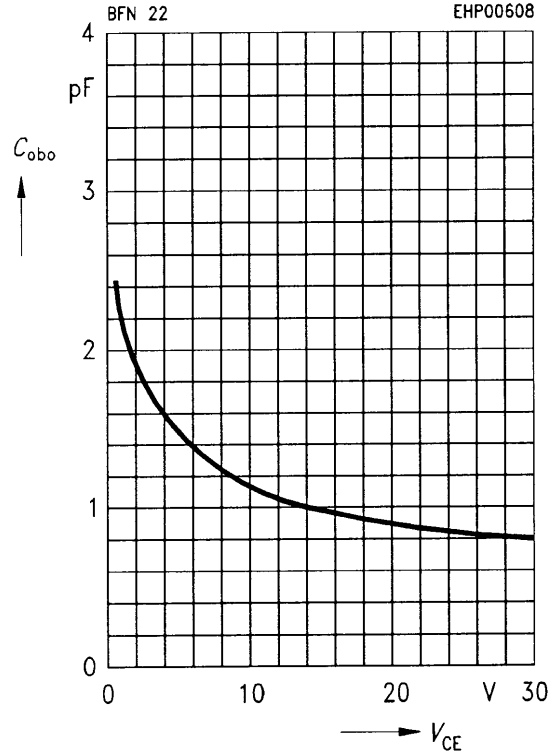

**Permissible pulse load  $P_{tot max}/P_{tot DC} = f(t_p)$**

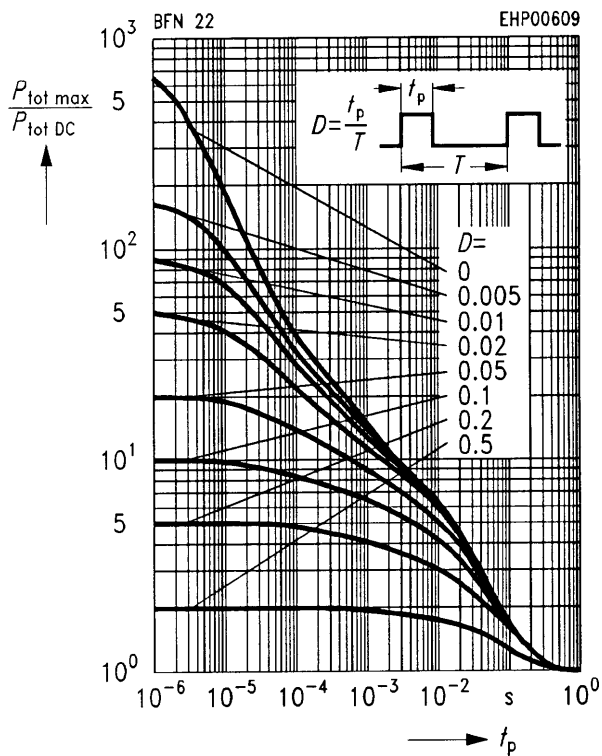

**Transition frequency  $f_T = f(I_C)$**

$V_{CE} = 10$  V

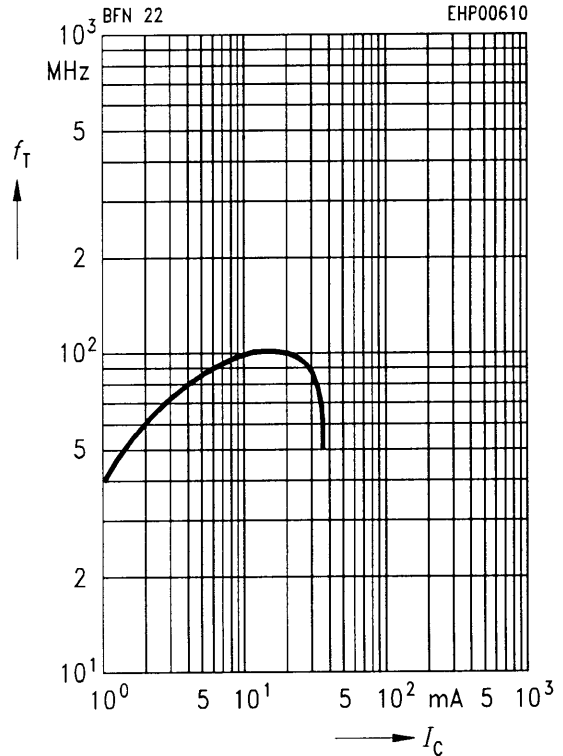

**Collector current  $I_C = f(V_{BE})$**

$V_{CE} = 20\text{ V}$

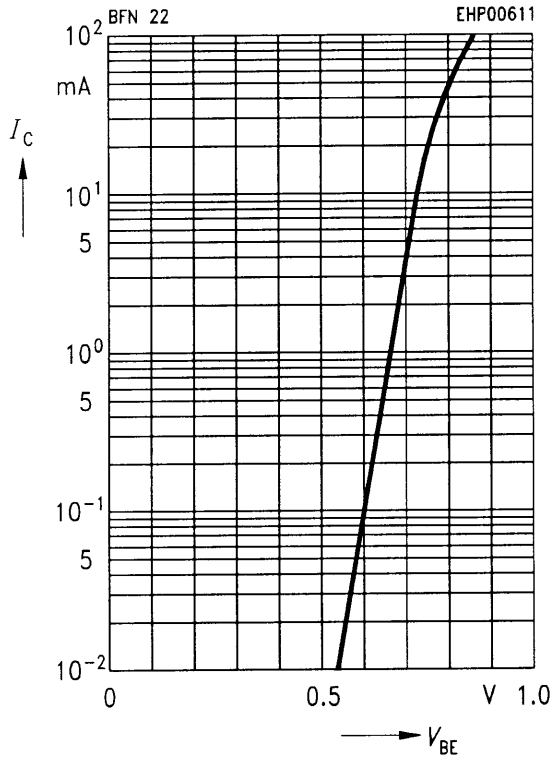

**DC current gain  $h_{FE} = f(I_C)$**

$V_{CE} = 20\text{ V}$

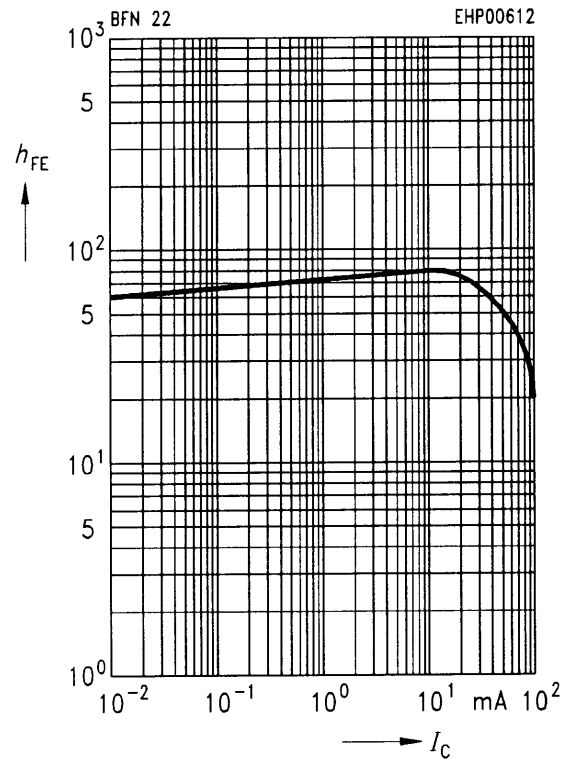

**Collector cutoff current  $I_{CB0} = f(T_A)$**

$V_{CB} = 200\text{ V}$

