

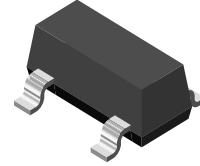

# Silicon NPN Planar RF Transistor

## Features

- Small feedback capacitance
- Low noise figure
- High transition frequency
- Lead (Pb)-free component
- Component in accordance to RoHS 2002/95/EC and WEEE 2002/96/EC

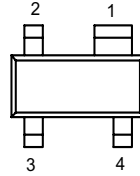

## Applications

RF amplifier up to 2 GHz, especially for mobile telephone.



Electrostatic sensitive device.  
Observe precautions for handling.

19217

## Mechanical Data

**Case:** SOT-143 Plastic case

**Weight:** approx. 8.0 mg

**Marking:** FA

### Pinning:

1 = Collector, 2 = Emitter,

3 = Base, 4 = Emitter

## Absolute Maximum Ratings

T<sub>amb</sub> = 25 °C, unless otherwise specified

Parameter	Test condition	Symbol	Value	Unit
Collector-base voltage		V <sub>CB0</sub>	25	V
Collector-emitter voltage		V <sub>CEO</sub>	16	V
Emitter-base voltage		V <sub>EBO</sub>	2	V
Collector current		I <sub>C</sub>	30	mA
Total power dissipation	T <sub>amb</sub> ≤ 60 °C	P <sub>tot</sub>	200	mW
Junction temperature		T <sub>j</sub>	150	°C
Storage temperature range		T <sub>stg</sub>	- 65 to + 150	°C

## Maximum Thermal Resistance

Parameter	Test condition	Symbol	Value	Unit
Junction ambient	<sup>1)</sup>	R <sub>thJA</sub>	450	K/W

<sup>1)</sup> on glass fibre printed board (25 x 20 x 1.5) mm<sup>3</sup> plated with 35 µm Cu

### Electrical DC Characteristics

T<sub>amb</sub> = 25 °C, unless otherwise specified

Parameter	Test condition	Symbol	Min	Typ.	Max	Unit
Collector-emitter cut-off current	V <sub>CE</sub> = 25 V, V <sub>BE</sub> = 0	I <sub>CES</sub>			100	μA
Collector-base cut-off current	V <sub>CB</sub> = 20 V, I <sub>E</sub> = 0	I <sub>CBO</sub>			100	nA
Emitter-base cut-off current	V <sub>EB</sub> = 2 V, I <sub>C</sub> = 0	I <sub>EBO</sub>			10	μA
Collector-emitter breakdown voltage	I <sub>C</sub> = 1 mA, I <sub>B</sub> = 0	V <sub>(BR)CEO</sub>	16			V
Collector-emitter saturation voltage	I <sub>C</sub> = 30 mA, I <sub>B</sub> = 3 mA	V <sub>CEsat</sub>		0.2	0.4	V
DC forward current transfer ratio	V <sub>CE</sub> = 10 V, I <sub>C</sub> = 5 mA	h <sub>FE</sub>	70	100	150	
	V <sub>CE</sub> = 10 V, I <sub>C</sub> = 15 mA	h <sub>FE</sub>	70	100		

### Electrical AC Characteristics

T<sub>amb</sub> = 25 °C, unless otherwise specified

Parameter	Test condition	Symbol	Min	Typ.	Max	Unit
Transition frequency	V <sub>CE</sub> = 10 V, I <sub>C</sub> = 5 mA, f = 500 MHz	f <sub>T</sub>		4.2		GHz
	V <sub>CE</sub> = 10 V, I <sub>C</sub> = 15 mA, f = 500 MHz	f <sub>T</sub>		5.8		GHz
Collector-base capacitance	V <sub>CB</sub> = 10 V, f = 1 MHz	C <sub>cb</sub>		0.3		pF
Collector-emitter capacitance	V <sub>CE</sub> = 10 V, f = 1 MHz	C <sub>ce</sub>		0.2		pF
Emitter-base capacitance	V <sub>EB</sub> = 0.5 V, f = 1 MHz	C <sub>eb</sub>		1.2		pF
Noise figure	V <sub>CE</sub> = 10 V, Z <sub>S</sub> = 50 Ω, f = 800 MHz, I <sub>C</sub> = 5 mA	F		1.4		dB
	V <sub>CE</sub> = 10 V, Z <sub>S</sub> = Z <sub>Sopt</sub> , f = 2 GHz, I <sub>C</sub> = 10 mA	F		2.5		dB
Power gain	V <sub>CE</sub> = 10 V, Z <sub>S</sub> = 50 Ω, Z <sub>L</sub> = Z <sub>Lopt</sub> , f = 800 MHz, I <sub>C</sub> = 5 mA	G <sub>pe</sub>		15.5		dB
	V <sub>CE</sub> = 10 V, Z <sub>S</sub> = 50 Ω, Z <sub>L</sub> = Z <sub>Lopt</sub> , f = 800 MHz, I <sub>C</sub> = 10 mA	G <sub>pe</sub>		16.5		dB
Linear output voltage - two tone intermodulation test	V <sub>CE</sub> = 10 V, I <sub>C</sub> = 25 mA, d <sub>IM</sub> = 60 dB, f <sub>1</sub> = 806 MHz, f <sub>2</sub> = 810 MHz, Z <sub>S</sub> = Z <sub>L</sub> = 50 Ω	V <sub>1</sub> = V <sub>2</sub>		160		mV
Third order intercept point	V <sub>CE</sub> = 10 V, I <sub>C</sub> = 25 mA, f = 800 MHz	IP <sub>3</sub>		27		dBm

## Common Emitter S-Parameters

$Z_0 = 50 \Omega$ ,  $T_{amb} = 25 \text{ }^\circ\text{C}$ , unless otherwise specified

$V_{CE}/V$	$I_C/mA$	f/MHz	S11		S21		S12		S22	
			LIN MAG	ANG	LIN MAG	ANG	LIN MAG	ANG	LIN MAG	ANG
				deg		deg		deg		deg
1	2	100	0.882	-26.99	6.43	158.5	0.040	73.0	0.944	-13.1
	2	300	0.702	-72.30	5.00	127.5	0.093	50.4	0.763	-29.1
	2	500	0.579	-104.7	3.81	107.8	0.115	39.3	0.621	-35.6
	2	800	0.496	-139.4	2.74	88.1	0.130	32.5	0.515	-40.2
	2	1000	0.474	-156.9	2.31	78.5	0.135	31.3	0.479	-43.0
	2	1200	0.480	-171.4	2.02	69.6	0.140	31.1	0.451	-46.1
	2	1500	0.495	170.3	1.70	57.4	0.148	32.9	0.422	-52.1
	2	1800	0.518	155.6	1.49	47.3	0.158	35.7	0.399	-59.3
	2	2000	0.541	147.6	1.38	40.8	0.169	37.8	0.388	-64.9
	2	2200	0.567	138.6	1.29	34.7	0.182	39.6	0.378	-70.8
	2	2500	0.599	128.1	1.17	26.1	0.207	38.5	0.363	-80.8
	2	2800	0.633	118.4	1.08	18.2	0.230	39.8	0.359	-93.6
2	3000	0.649	113.2	1.03	13.9	0.249	39.0	0.350	-102.5	
3	2	100	0.894	-23.2	6.52	160.8	0.027	75.5	0.960	-9.3
	2	300	0.729	-62.8	5.27	132.3	0.066	55.0	0.832	-21.1
	2	500	0.590	-93.5	4.16	112.8	0.084	44.3	0.719	-26.1
	2	800	0.482	-128.6	3.04	93.4	0.097	37.9	0.631	-30.1
	2	1000	0.445	-146.8	2.58	83.6	0.101	37.2	0.601	-32.7
	2	1200	0.438	-163.0	2.24	74.9	0.106	37.9	0.580	-35.3
	2	1500	0.448	176.6	1.90	63.0	0.113	40.7	0.555	-40.1
	2	1800	0.467	160.8	1.64	53.3	0.123	44.7	0.537	-45.7
	2	2000	0.489	150.7	1.52	46.9	0.133	47.3	0.529	-50.1
	2	2200	0.514	141.4	1.43	41.0	0.146	50.0	0.522	-54.5
	2	2500	0.541	130.2	1.30	32.0	0.168	48.6	0.509	-62.1
	2	2800	0.577	120.0	1.19	24.5	0.190	51.1	0.508	-71.7
2	3000	0.599	114.6	1.13	20.1	0.208	50.6	0.492	-78.2	
3	5	100	0.758	-35.5	13.77	152.1	0.025	70.5	0.903	-16.0
	5	300	0.514	-87.7	9.17	118.5	0.051	53.8	0.660	-28.3
	5	500	0.396	-120.7	6.36	101.2	0.064	51.0	0.540	-29.0
	5	800	0.336	-154.3	4.30	85.4	0.082	52.5	0.477	-29.0
	5	1000	0.322	-171.3	3.54	77.4	0.094	53.9	0.460	-30.2
	5	1200	0.328	175.2	3.03	70.2	0.108	54.4	0.450	-32.4
	5	1500	0.347	160.0	2.51	60.3	0.129	54.7	0.432	-37.0
	5	1800	0.376	146.7	2.15	51.8	0.150	54.1	0.415	-42.5
	5	2000	0.394	139.8	1.98	46.0	0.166	53.3	0.407	-46.8
	5	2200	0.415	132.2	1.85	40.8	0.182	52.3	0.399	-51.1
	5	2500	0.450	124.1	1.68	32.6	0.206	48.4	0.381	-58.9
	5	2800	0.484	115.7	1.54	25.4	0.227	47.3	0.371	-68.4
5	3000	0.504	111.2	1.46	20.9	0.244	45.5	0.354	-74.9	
6	2	100	0.899	-21.53	6.49	161.9	0.022	76.2	0.967	-7.6

$V_{CE}/V$	$I_C/mA$	f/MHz	S11		S21		S12		S22	
			LIN MAG	ANG	LIN MAG	ANG	LIN MAG	ANG	LIN MAG	ANG
				deg		deg		deg		deg
	2	300	0.743	-58.80	5.34	134.2	0.054	56.9	0.865	-17.5
	2	500	0.600	-88.40	4.26	114.8	0.069	46.8	0.768	-21.9
	2	800	0.480	-122.7	3.14	95.5	0.080	40.5	0.691	-25.6
	2	1000	0.434	-141.9	2.67	85.8	0.084	40.3	0.666	-27.9
	2	1200	0.424	-159.0	2.33	77.2	0.088	41.4	0.649	-30.3
	2	1500	0.424	180.0	1.96	65.4	0.094	45.2	0.630	-35.0
	2	1800	0.445	162.6	1.70	55.7	0.103	50.2	0.613	-40.0
	2	2000	0.462	152.5	1.57	49.4	0.113	53.4	0.608	-43.8
	2	2200	0.488	142.4	1.47	43.6	0.125	56.3	0.603	-47.8
	2	2500	0.519	131.1	1.34	34.9	0.147	55.2	0.594	-54.5
	2	2800	0.553	120.5	1.23	26.9	0.167	58.1	0.596	-62.8
	2	3000	0.572	114.7	1.16	22.8	0.185	57.7	0.581	-68.5
6	5	100	0.773	-32.2	13.83	153.5	0.020	72.6	0.920	-12.8
	5	300	0.527	-80.7	9.50	120.6	0.042	55.5	0.718	-22.7
	5	500	0.388	-112.7	6.68	102.9	0.054	53.2	0.614	-23.5
	5	800	0.312	-147.3	4.50	86.9	0.069	54.9	0.560	-24.1
	5	1000	0.291	-166.0	3.71	79.1	0.079	56.5	0.547	-25.7
	5	1200	0.297	179.2	3.18	72.0	0.091	57.4	0.538	-27.6
	5	1500	0.311	162.6	2.62	62.2	0.109	58.2	0.524	-32.1
	5	1800	0.334	148.1	2.24	53.9	0.127	58.4	0.511	-37.1
	5	2000	0.356	140.9	2.07	48.4	0.142	58.0	0.505	-40.8
	5	2200	0.379	133.1	1.92	43.2	0.156	57.4	0.500	-44.7
	5	2500	0.414	124.1	1.75	34.9	0.179	53.9	0.486	-51.3
	5	2800	0.448	115.6	1.60	27.7	0.197	53.6	0.480	-59.4
	5	3000	0.467	111.7	1.52	23.8	0.214	51.8	0.464	-64.8
6	10	100	0.610	-46.2	21.97	144.1	0.017	68.7	0.851	-18.0
	10	300	0.357	-103.2	12.24	110.2	0.034	60.4	0.599	-23.9
	10	500	0.271	-135.9	7.99	95.4	0.047	62.4	0.522	-21.6
	10	800	0.239	-169.4	5.21	82.3	0.068	64.4	0.494	-21.0
	10	1000	0.236	173.8	4.26	75.5	0.082	64.8	0.490	-22.7
	10	1200	0.243	162.9	3.60	69.3	0.097	64.5	0.486	-24.7
	10	1500	0.265	149.9	2.96	60.5	0.119	62.9	0.474	-29.6
	10	1800	0.287	138.6	2.51	53.0	0.140	60.9	0.461	-34.8
	10	2000	0.306	133.6	2.32	47.7	0.156	59.2	0.455	-38.6
	10	2200	0.329	126.8	2.15	42.9	0.171	57.8	0.449	-42.6
	10	2500	0.368	119.2	1.96	35.2	0.194	53.3	0.430	-49.3
	10	2800	0.403	112.7	1.79	28.3	0.214	51.8	0.421	-57.5
	10	3000	0.418	109.4	1.69	24.2	0.229	49.7	0.404	-62.7
6	20	100	0.431	-64.8	29.52	134.0	0.014	67.9	0.761	-21.8



V <sub>CE</sub> /V	I <sub>C</sub> /mA	f/MHz	S11		S21		S12		S22	
			LIN MAG	ANG	LIN MAG	ANG	LIN MAG	ANG	LIN MAG	ANG
				deg		deg		deg		deg
	20	300	0.258	-129.4	13.70	102.6	0.030	67.6	0.524	-21.2
	20	500	0.223	-159.9	8.61	90.4	0.045	69.6	0.479	-17.7
	20	800	0.217	172.5	5.52	79.0	0.068	70.3	0.467	-17.7
	20	1000	0.222	159.4	4.48	72.8	0.083	69.3	0.468	-19.9
	20	1200	0.230	151.1	3.78	67.2	0.099	68.0	0.466	-22.2
	20	1500	0.253	141.6	3.10	59.1	0.122	65.2	0.457	-27.4
	20	1800	0.276	132.6	2.64	51.8	0.145	62.6	0.445	-32.8
	20	2000	0.294	128.4	2.42	46.7	0.161	60.5	0.438	-36.8
	20	2200	0.319	122.8	2.25	42.3	0.177	58.6	0.431	-40.8
	20	2500	0.356	116.2	2.04	34.8	0.199	53.9	0.412	-47.6
	20	2800	0.386	110.2	1.86	27.9	0.219	51.8	0.402	-55.7
20	3000	0.408	107.5	1.77	23.9	0.235	49.4	0.383	-61.0	
10	2	100	0.905	-20.86	6.45	162.4	0.019	76.9	0.971	-6.7
	2	300	0.751	-57.1	5.35	135.1	0.047	58.1	0.882	-15.4
	2	500	0.605	-85.8	4.29	116.0	0.061	47.9	0.795	-19.4
	2	800	0.476	-120.2	3.19	96.4	0.070	42.0	0.729	-23.1
	2	1000	0.432	-138.8	2.70	86.7	0.074	42.1	0.705	-25.2
	2	1200	0.410	-156.8	2.35	78.0	0.077	43.8	0.691	-27.6
	2	1500	0.411	-178.0	1.99	66.4	0.083	48.3	0.674	-32.1
	2	1800	0.430	163.7	1.72	56.9	0.091	54.0	0.661	-37.0
	2	2000	0.445	153.8	1.59	50.5	0.101	57.5	0.657	-40.4
	2	2200	0.477	143.9	1.48	44.6	0.112	60.7	0.656	-44.1
	2	2500	0.502	131.3	1.34	35.9	0.133	59.4	0.648	-50.4
	2	2800	0.539	120.8	1.23	28.1	0.152	62.9	0.651	-57.9
2	3000	0.558	115.3	1.16	24.0	0.170	62.6	0.637	-63.3	
10	5	100	0.789	-30.8	13.74	154.2	0.017	73.5	0.932	-11.0
	5	300	0.540	-77.6	9.54	121.5	0.037	56.4	0.754	-19.6
	5	500	0.392	-108.4	6.74	103.7	0.047	53.8	0.662	-20.4
	5	800	0.305	-143.1	4.57	87.7	0.060	56.1	0.615	-21.4
	5	1000	0.281	-162.3	3.76	79.9	0.070	57.9	0.604	-23.0
	5	1200	0.279	-178.1	3.21	72.7	0.080	59.4	0.596	-25.1
	5	1500	0.293	164.4	2.66	63.0	0.096	60.6	0.585	-29.3
	5	1800	0.316	148.8	2.27	54.8	0.113	61.1	0.574	-34.1
	5	2000	0.335	141.7	2.09	49.3	0.126	61.3	0.571	-37.6
	5	2200	0.364	134.1	1.95	44.4	0.139	61.1	0.567	-41.3
	5	2500	0.396	124.7	1.77	36.2	0.160	57.5	0.555	-47.5
	5	2800	0.431	115.9	1.61	28.7	0.178	57.9	0.553	-54.8
5	3000	0.452	111.5	1.53	24.8	0.194	56.4	0.538	-59.7	
10	10	100	0.640	-43.3	21.78	145.1	0.015	70.2	0.869	-15.3

$V_{CE}/V$	$I_C/mA$	$f/MHz$	S11		S21		S12		S22	
			LIN MAG	ANG	LIN MAG	ANG	LIN MAG	ANG	LIN MAG	ANG
				deg		deg		deg		deg
10	10	300	0.368	-97.7	12.37	111.1	0.030	60.9	0.651	-20.1
	10	500	0.265	-130.1	8.09	96.1	0.042	62.8	0.582	-18.2
	10	800	0.226	-164.9	5.28	82.7	0.060	65.2	0.558	-18.7
	10	1000	0.216	178.2	4.30	76.0	0.072	65.9	0.554	-20.6
	10	1200	0.224	165.2	3.65	69.8	0.085	65.9	0.551	-22.8
	10	1500	0.245	150.4	2.99	61.2	0.105	64.8	0.542	-27.2
	10	1800	0.269	138.6	2.55	53.4	0.124	63.6	0.532	-32.3
	10	2000	0.290	133.1	2.34	48.5	0.139	62.4	0.528	-36.0
	10	2200	0.309	125.6	2.17	43.7	0.152	61.3	0.523	-39.4
	10	2500	0.349	119.9	1.97	36.2	0.174	56.8	0.508	-45.8
	10	2800	0.383	112.9	1.80	29.2	0.191	56.0	0.504	-53.1
	10	3000	0.404	109.2	1.71	25.4	0.206	54.0	0.487	-57.9
10	20	100	0.476	-60.3	29.33	135.0	0.013	68.9	0.793	-18.3
	20	300	0.262	-120.8	13.84	103.3	0.026	66.8	0.586	-17.8
	20	500	0.210	-153.3	8.70	90.9	0.040	69.6	0.547	-15.2
	20	800	0.200	176.6	5.58	79.4	0.060	70.9	0.538	-16.0
	20	1000	0.204	162.2	4.53	73.3	0.073	70.4	0.538	-18.3
	20	1200	0.213	151.6	3.82	67.7	0.087	69.2	0.537	-20.8
	20	1500	0.235	142.5	3.13	59.7	0.108	67.3	0.529	-25.5
	20	1800	0.258	132.5	2.67	52.4	0.128	65.1	0.519	-30.8
	20	2000	0.273	128.1	2.43	47.7	0.143	63.4	0.513	-34.4
	20	2200	0.302	122.4	2.26	43.1	0.157	62.0	0.511	-38.0
	20	2500	0.337	116.2	2.05	35.5	0.179	57.5	0.496	-44.4
	20	2800	0.368	110.7	1.87	28.7	0.196	56.1	0.488	-51.7
	20	3000	0.390	107.3	1.77	25.1	0.211	54.0	0.471	-56.5

### Typical Characteristics ( $T_{amb} = 25\text{ }^\circ\text{C}$ unless otherwise specified)

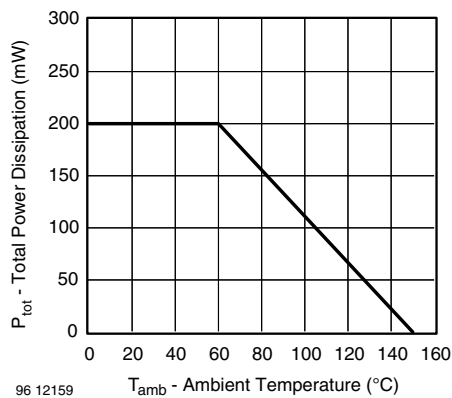

Figure 1. Total Power Dissipation vs. Ambient Temperature

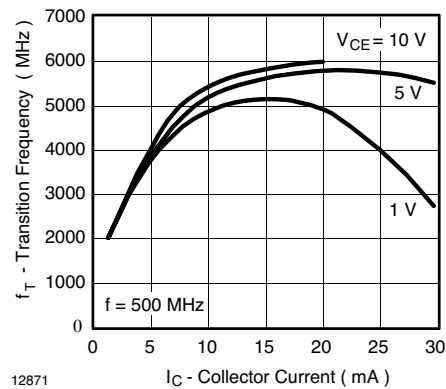

Figure 2. Transition Frequency vs. Collector Current

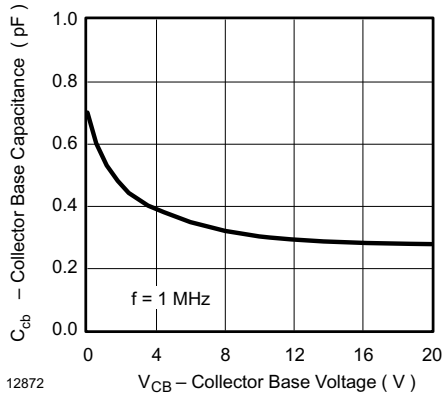

Figure 3. Collector Base Capacitance vs. Collector Base Voltage

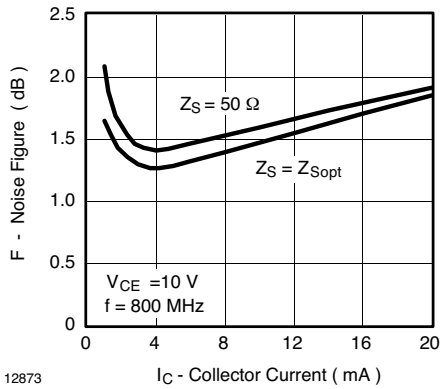

Figure 4. Noise Figure vs. Collector Current

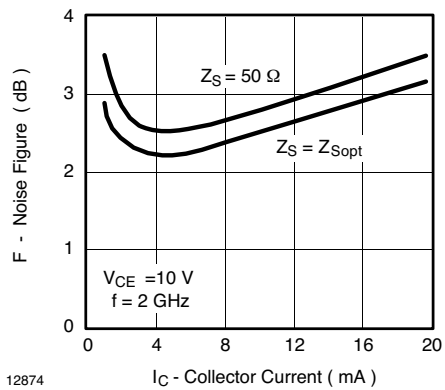
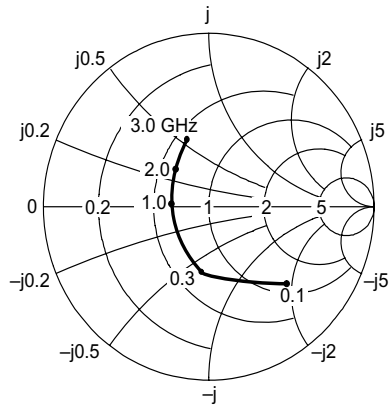

Figure 5. Noise Figure vs. Collector Current

$V_{CE} = 10\text{ V}$ ,  $I_C = 10\text{ mA}$ ,  $Z_0 = 50\ \Omega$

$S_{11}$



12978

Figure 6. Input Reflection Coefficient

$S_{21}$

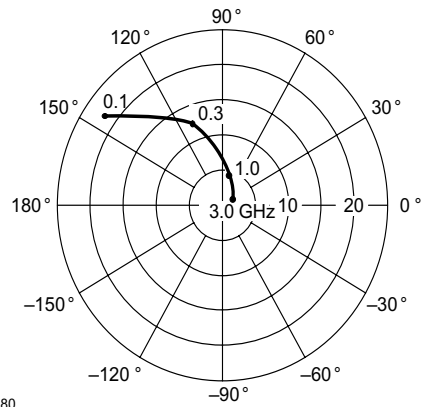

12980

Figure 8. Forward Transmission Coefficient

$S_{12}$

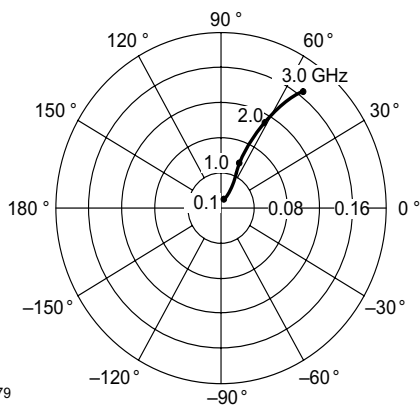

12979

Figure 7. Reverse Transmission Coefficient

$S_{22}$

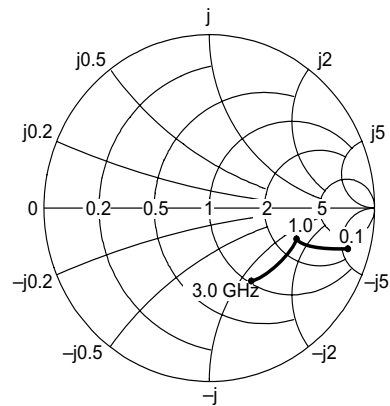

12981

Figure 9. Output Reflection Coefficient



## Package Dimensions in mm

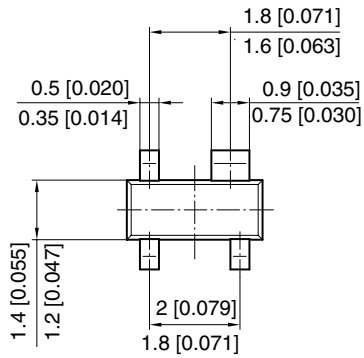
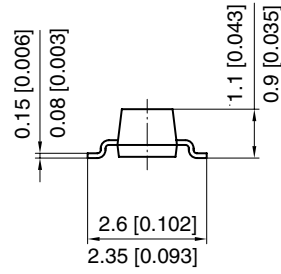
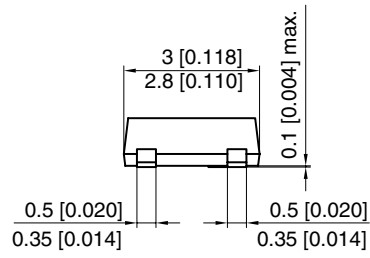

foot print recommendation:

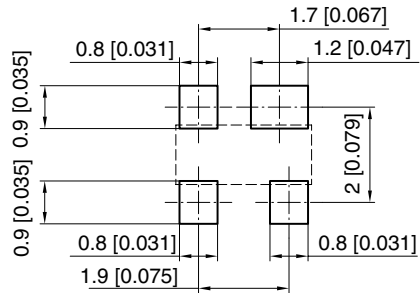

96 12240  
Rev. 5 - Date: 25 January 2005  
Document no.: 6.541-5015.01-4

### Ozone Depleting Substances Policy Statement

It is the policy of Vishay Semiconductor GmbH to

1. Meet all present and future national and international statutory requirements.
2. Regularly and continuously improve the performance of our products, processes, distribution and operating systems with respect to their impact on the health and safety of our employees and the public, as well as their impact on the environment.

It is particular concern to control or eliminate releases of those substances into the atmosphere which are known as ozone depleting substances (ODSs).

The Montreal Protocol (1987) and its London Amendments (1990) intend to severely restrict the use of ODSs and forbid their use within the next ten years. Various national and international initiatives are pressing for an earlier ban on these substances.

Vishay Semiconductor GmbH has been able to use its policy of continuous improvements to eliminate the use of ODSs listed in the following documents.

1. Annex A, B and list of transitional substances of the Montreal Protocol and the London Amendments respectively
2. Class I and II ozone depleting substances in the Clean Air Act Amendments of 1990 by the Environmental Protection Agency (EPA) in the USA
3. Council Decision 88/540/EEC and 91/690/EEC Annex A, B and C (transitional substances) respectively.

Vishay Semiconductor GmbH can certify that our semiconductors are not manufactured with ozone depleting substances and do not contain such substances.

We reserve the right to make changes to improve technical design  
and may do so without further notice.

Parameters can vary in different applications. All operating parameters must be validated for each customer application by the customer. Should the buyer use Vishay Semiconductors products for any unintended or unauthorized application, the buyer shall indemnify Vishay Semiconductors against all claims, costs, damages, and expenses, arising out of, directly or indirectly, any claim of personal damage, injury or death associated with such unintended or unauthorized use.

Vishay Semiconductor GmbH, P.O.B. 3535, D-74025 Heilbronn, Germany



## Disclaimer

All product specifications and data are subject to change without notice.

Vishay Intertechnology, Inc., its affiliates, agents, and employees, and all persons acting on its or their behalf (collectively, "Vishay"), disclaim any and all liability for any errors, inaccuracies or incompleteness contained herein or in any other disclosure relating to any product.

Vishay disclaims any and all liability arising out of the use or application of any product described herein or of any information provided herein to the maximum extent permitted by law. The product specifications do not expand or otherwise modify Vishay's terms and conditions of purchase, including but not limited to the warranty expressed therein, which apply to these products.

No license, express or implied, by estoppel or otherwise, to any intellectual property rights is granted by this document or by any conduct of Vishay.

The products shown herein are not designed for use in medical, life-saving, or life-sustaining applications unless otherwise expressly indicated. Customers using or selling Vishay products not expressly indicated for use in such applications do so entirely at their own risk and agree to fully indemnify Vishay for any damages arising or resulting from such use or sale. Please contact authorized Vishay personnel to obtain written terms and conditions regarding products designed for such applications.

Product names and markings noted herein may be trademarks of their respective owners.